

2012

STAR TREK

THE NEXT GENERATION



FASA
CORPORATION

OFFICER'S MANUAL

STAR TREK[®]

THE NEXT GENERATION



OFFICER'S MANUAL

STATEMENT OF FEDERATION GRAND ALLIANCE	4	Starfleet Uniforms	17
INTRODUCTION	5	Interim Designs	17
Map	6	Current Designs	17
Great Seal of the Federation Grand Alliance	6	Officer Uniforms	17
EVOLUTION OF STAR FLEET	7	Enlisted Men Uniforms	17
Ranks And Insignia	7	Warrant Officer Uniforms	17
Officers	7	Note on Personal Communicators	17
Enlisted Men	10	Starfleet Security Codes	25
Warrant Officers	10	SSC 1-29	25
New Starfleet Officer Positions	10	SSC 30-50	25
Bridge Command Specialist	10	Starfleet Decorations	25
Ship's Counselor	10	Anastas Medal of Achievement	26
Ship's Crewmaster	11	Andorian Battle Star	26
Starship Systems Specialist	11	Citation of Conspicuous Gallantry	26
Starfleet Tactical Officer	11	Cochrane Award	26
Starship Chain of Command	11	Denebian Swan of Merit	26
Career Opportunities	11	Grankite Order of Honor	26
Post-Academy Training	12	Karagite Order of Heroism	27
Peacetime Positions	12	Starfleet Medal of Honor	27
Recruitment Guidelines and Privileges	13	Starfleet Medal of Valor	27
Pay Rates	13	Prantares Ribbon	27
Leave Time	13	Shuvalis Diamond of Recognition	27
Family Unity	13	Federation Peace Medal	27
Education	13	Academy Slang	28
Retirement	13	EVOLUTION OF THE TRANSWARP FLEET	29
Medical Care	13	Fleet of Tomorrow	29
Death Benefits	14	Fleet Ship Designs	29
Disability Benefits	14	<i>Excelsior</i> Class XIII Transwarp Battleship	30
Severance Pay	14	<i>Enterprise</i> Class XII Cruiser	32
Reenlistment Bonus	14	<i>Constellation</i> Class XII Heavy Cruiser	34
Travel Guarantee	14	<i>Decker</i> Class X Transwarp Destroyer	36
Clothing	14	<i>Royal Sovereign</i> Class XV Battlecruiser	38
Space Service	14	<i>M'Benga</i> Class VII Rescue/Hospital Ship	40
Enlisted Personnel Training	14	<i>Sagan</i> Class V Science Research Vessel	42
Enlisted Preferred Program	14	<i>Wellington</i> Class XI Transwarp Light Cruiser	44
Enlisted Basic Program	14	<i>Paine</i> Class IX Transwarp Frigate	46
Promotion Guidelines	14	<i>Moscow</i> Class IX Transwarp Scout	48
Integrating New Races	15	<i>S-20</i> Standard Administrative Shuttle	50
Rapid Integration Program	15	<i>SC-22</i> Sphinx Class Cargo Shuttle	51
		<i>Ambassador</i> Transwarp Heavy Cruiser	52
		<i>SW-21</i> Long-Range Warp Shuttle	54

Copyright © 1988. All Rights Reserved.

STAR TREK is a Registered Trademark of Paramount Pictures Corporation.

STAR TREK: The Role Playing game is published by FASA Corporation under license from Paramount Pictures Corporation, the trademark owner.

Printed in The United States of America.



Published by
FASA Corporation
P.O. Box 6930
Chicago, IL 60680

GALAXY CLASS EXPLORATION CRUISER	55	Gorn	120
The Shape of Things to Come	55	Turellians	120
Mission Statement	55	SCIENTIFIC ADVANCES	121
General Statistics	56	Advent of Artificial Beings	122
Shipboard Facilities	59	Schematic Overview	123
Saucer Command Section	59	Holodeck Operation	125
Star Drive Section	72	Advances in Shipboard Weaponry	125
Ship Equipment	78	GALACTIC EXPLORATION	127
General Equipment	78	Federation Grand Alliance	127
Medical Equipment	86	New Races	128
Personal Weapons	91	Federation Members	128
Engineering Equipment	95	Independents	131
Security Ordnance	98	STAR FLEET POLICIES AND PROCEDURES	134
Starship Weaponry	102	Advanced Training Programs	134
Phaser Systems	102	Integrated Specialist	134
Photon Torpedoes	102	Academy Core Curriculum	135
Zero-Lethality Weapon Systems	102	Away Teams	137
Defensive Systems	102	Away Team Operations	137
Secondary Defense Systems	104	New General Orders	137
Shipboard Life	106	General Order 26	137
FRIENDS AND FOES	107	General Order 27	137
Klingon Defense Force	107	General Order 28	137
K'Mirra <i>Alliance</i> Class Battlecruiser	108	General Order 29	137
Klingon Defense Force Uniforms	109	General Order 30	137
Ferengi Empire	110	General Order 31	137
Operations	110	Pay and Provisions	138
Sphere of Influence	110	Officer's Pay	138
Physical Appearance	110	Enlisted Personnel Pay	138
Ferengi Navy	110	Provisions for Civilians	139
Ferengi <i>Marauder</i>	112	BIOGRAPHIES	140
Ferengi Weapons	113	Noonian Soong	140
Ferengi Society	113	Simone Van Gelder	141
The "Q"	114	Koren Anastas	142
Imperial Klingon States	114	Jean-Luc Picard	143
Orions	116	Worf	144
Romulans	117		
<i>D'daridex</i> (Executioner) Class			
Transwarp Battlecruiser	119		

STAR TREK: THE NEXT GENERATION OFFICER'S MANUAL

Writing

Rick Stuart
John Terra

Editorial Staff

Editor-in-Chief
L. Ross Babcock III
Senior Editor
Donna Ippolito
Editorial Assistant
C. R. Green

Galaxy Class Technical Advisor

Edwin Lee Zamora

Production Staff

Production Manager
Jordan K. Weisman
Production Coordinator
Tara Gallagher
Art Director
Dana Knutson
Cover Design
Jim Nelson
Deck Plans
Steve Venters
Cutaway Illustrations
David R. Dietrick

Ship Illustrations

Dana Knutson

Illustration

Rob Caswell
A.C. Farley
Jim Nelson
Jeff Laubenstein
Todd F. Marsh

Typesetting

Patrice A. Jones
Tara Gallagher

Layout

Tara Gallagher

STATEMENT OF FEDERATION GRAND ALLIANCE

We, the assembled delegates of the United Federation of Planets and the representatives of the Free Worlds of Klinzhái, in accordance with the principles of Peace and the dictates of mutual respect for all sentient life forms, do hereby pledge our desire to henceforth live in mutual harmony and safety from this day on.

We acknowledge the rights of our respective peoples to live, each in accordance with their own social systems, to share in the wealth of scientific and cultural exchange, to support each other in times of need, and never to forget that we are each free beings, capable of the highest ideals and the grandest vision.

We claim as our mutual heritage the rights of self determination, freedom from oppression or coercion, the right to pursue personal glory in keeping with our own standards and expectations, the benefits of trust and cooperation, and the end of suspicion and racial bigotry.

Thus do we, the assembled representatives of our two governments, henceforth pledge, to ourselves and our posterity, to live in peace so long as a single sun shall shine in our heavens, secure in the knowledge of our own greatness and with the hope of a secure future tomorrow and for all tomorrows to come.

This document is rated UNCLASSIFIED (SECLAR 0). Materials presented here are widely available throughout the Federation. Certain sections have been edited or otherwise altered to ensure that sensitive materials are not published, per Classified Documents Directive 998.21H. All materials in this manual are to be used for familiarization purposes only.
Classified Documents Directive 998.21H

This Officer's Manual is a survey of the current state of the United Federation of Planets and Starfleet Command. Prepared by the United Federation of Planets Office of Academic Training under the auspices of the Commandant of Starfleet Academy, the volume introduces freshmen cadets to the conditions in Starfleet today. It covers Starfleet ranks and decorations, uniforms, equipment, training, weapons, shipboard lifestyles, chain-of-command, starship designs, the Klingon Defense Force, and the advent of the artificial being. This introductory booklet will also serve as a reference or as a supplement to other Starfleet Academy texts.

In recent days, critics of Starfleet have proposed that the Alliance High Council disband Starfleet Command and reallocate its resources to nonviolent pursuits. These advocates of political neutrality argue that the Federation no longer faces the threats that made Starfleet necessary in the past. They point to the breakup of the Klingon Empire, the quiescence of the Orions, the accommodation with the Gorn, and the continuing inaction on the Romulan border. Despite this criticism, Starfleet will continue to exist in the foreseeable future. We cannot ignore the existence of the Imperial Klingon States, which many believe is a refuge for "true Klingons." There is also the growing presence of the Ferengi, a largely unknown but indisputably aggressive race that seems hostile to the principle of individual freedom. Moreover, the quiet Romulans wait and watch for signs of weakness or lack of resolve as they plan for a final reckoning.

Beyond the issue of outside threats, there is also disagreement within the Alliance over how to maintain peace. Some argue that planetary governments should determine their own defensive needs, and that Starfleet should disband in favor of planetary navies. There are also those who forget that Starfleet exists not simply to maintain peace, nor even to maintain individual cultures. What Starfleet stands for is the belief that sentient races can live in harmony and respect for individual rights.

Since its founding, Starfleet Command has been enmeshed in controversy and constant change. This is even truer today because of the events of the last several decades. Among these are the introduction of new technologies (originating in both the civilian and military sectors), the revision of training procedures to include more races in Starfleet, the adoption of policies allowing civilian personnel aboard fleet vessels, and the introduction of new officer grades and command positions. The Starfleet of today, both in structure and in mission, is the result of an evolutionary process extending over many decades. Starfleet has grown and changed to meet new demands and challenges, and it will continue to do so.

—Admiral Thrifis Chovich, Commandant, Starfleet Academy



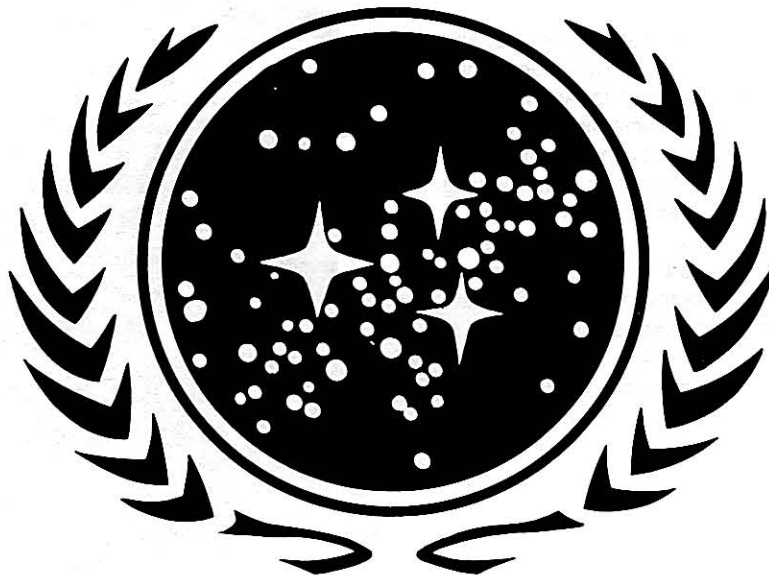
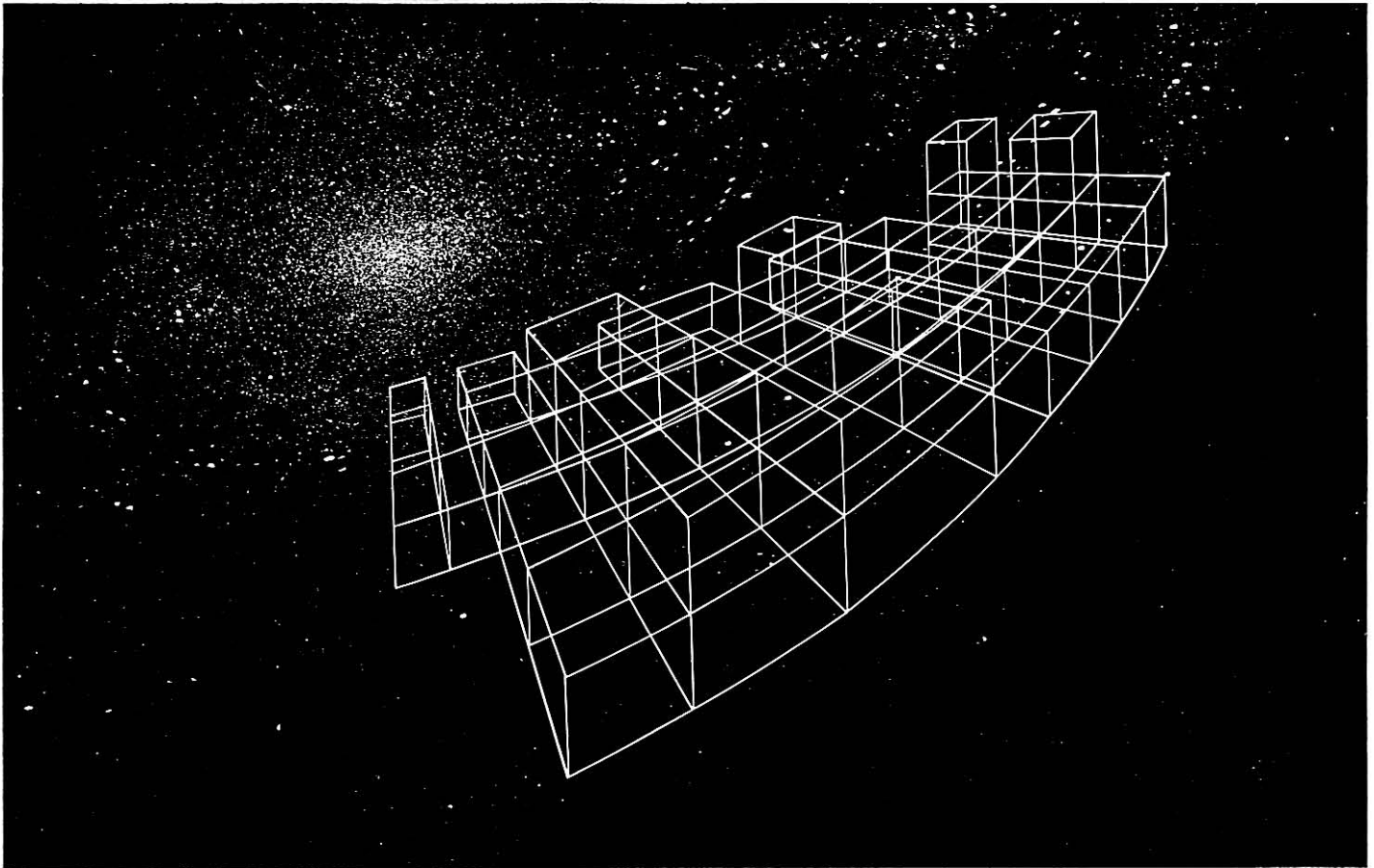

GREAT SEAL OF THE FEDERATION GRAND ALLIANCE

Used by officials of the Federation Alliance and displayed on all government buildings and installations, the Great Seal represents unity between the United Federation of Planets and the Free Worlds of Klinzhai.

A modified version of the original Federation seal, the Great Seal of the Alliance shows a field of silver stars against a backdrop of blue space, surrounded by olive branches. The notable difference from the original device is that three stars are of greater size and brilliance, to symbolize the three principal worlds—Terra, Klinzhai, and Vulcan—involved in the formation of the Grand Alliance.

RANKS AND INSIGNIA

In the last decade, the system of ranks used within Starfleet Command has been modified for greater flexibility. These modifications have altered the chain of command as well as uniform insignia. Starfleet officers are generally distinguished as being either Flag or Staff Officers, the former with duties aboard a fleet vessel and the latter with non-shipboard responsibilities. The following specifications summarize the Starfleet chain of command and describe the vessel insignia. Some variations in emblems may be possible, at a commanding officer's discretion.

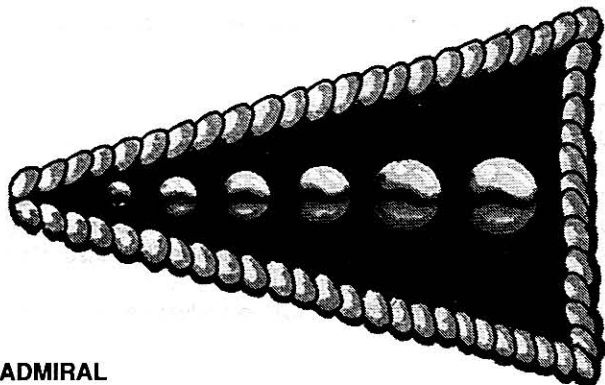

ADMIRAL

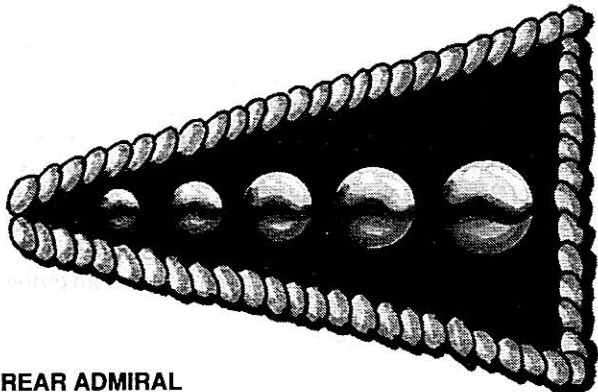

REAR ADMIRAL

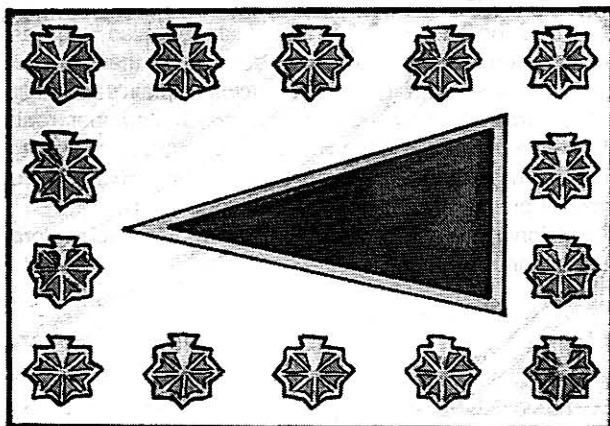

BRANCH ADMIRAL

OFFICERS

Admiral

The rank of Admiral is the highest in Starfleet. Flag Admirals are responsible for the deployment of Starfleet vessels in active operations, particularly fleet operations along the border zones between the Federation and foreign governments. Flag Admirals are also responsible for exploration and training craft as well as Federation colonization efforts. Staff positions encompass a variety of roles, ranging from diplomatic and scientific to traditional planning and organizational tasks within Starfleet. Separate Admiralty Commands include directorship of Starfleet training operations, diplomatic liaisons with Federation member-worlds, and negotiations with newly discovered worlds. They also include a host of military positions: contingency strategy, weapons research and development, and scientific systems deployment aboard Starfleet vessels.

The insignia for Admiral is a triangular shoulder board with gold braid enclosing six gold circles of varying size.

Rear Admiral

The position of Rear Admiral is similar to that of the Senior Flag and Staff Officers described above. Rear Admirals differ from their superiors in that their positions usually carry a specific geographical area of responsibility, such as a quadrant or sector within Federation space. Flag Officers holding Rear Admiral rank command Task Force Groups of eight to twelve vessels. Rear Admirals might also command important ground installations as well as vessels that fall within their specific area of jurisdiction. Staff positions of this rank can include command of Starfleet ship construction and production facilities or science and weapons labs, primary base security, security for Federation officials, procurement, and scientific analysis (especially in sensitive areas such as intelligence-gathering or clandestine operations).

The insignia for Rear Admiral is a triangular shoulder board with gold braid enclosing five gold circles of varying size.

Branch Admiral

To give greater authority to the most qualified officers in specialized branches of operation, Starfleet has revamped its ranking system, extending Admiral's rank and privileges to such positions as Starfleet Surgeon-General. The change gives these officers greater control over implementation of their policies throughout the fleet. Admiral designations have been established for the Medical, Security, and Engineering branches. In addition, the Starfleet Inspector General's Office has promoted some individuals to Branch Admiral to facilitate inspection of vessels and ground installations throughout the Federation.

The insignia designation for Branch Admiral is a color-coded triangle with the apex facing inward, set on a white shoulder board surrounded by silver oak leaves. Triangle colors reflect branch designations: silver for the Inspector General's Office, green for Medical Corps, gold for Security, and red for Engineering.



FLEET CAPTAIN



COMMODORE



CAPTAIN



COMMANDER

Fleet Captain

The position is that of a senior officer who has demonstrated exceptional competence and expertise in active service over a length of time. Fleet Captains are responsible for the overall deployment of specific classes of vessels throughout the fleet. In that capacity, they oversee the construction, refitting, upgrading, and operational use of a particular vessel design, rather than taking command over individual craft. At present, there are three Fleet Captains. One is responsible for *Excelsior* and *Alaska* Class heavy warships; the second is in charge of heavy cruiser class designs; and the third oversees the deployment of *Galaxy* class and other long-range, transwarp combat ships.

The insignia for Fleet Captain is five solid gold circles worn on the right uniform collar.

Commodore

Officers above the rank of Captain generally have served in a variety of vital areas, including Exploration, Military Operations, and Fleet Command. Flag officers of Commodore rank command Tactical Operations Groups of three to six vessels. A Commodore may also serve as a Star Base Commander or Fleet Inspector, reporting to a Rear Admiral.

The insignia for Commodore is five solid silver circles worn on the right uniform collar.

Captain

Captains command Starfleet vessels above Class V. Captains also direct the day-to-day operational deployment and tactical command of support craft, often without the direct influence of senior commanders. Flag Officers with technical skills in areas such as Engineering, Science, Medicine, or Security may also receive Captain's rank and usually serve aboard larger vessels. Staff officers of Captain rank typically serve in deputy positions on star bases or similar ground assignments, as aides to Flag Admirals, or technical advisers to senior Federation personnel.

The insignia for Captain is four solid silver circles worn on the right uniform collar.

Commander

Commanders generally head up a department aboard ship. A Senior Flag Commander may have a specialized position, such as First Officer or Science Officer. Commanders also serve as ship's Captain on vessels below Class V, receiving the technical distinction of Brevet Captain, which bestows Captain's authority only on board ship. Staff officers holding Commander rank typically serve as aides to senior officers or as special-duty personnel for inspection of civilian installations, liaison with native life forms, or providing administrative support.

The insignia for Commander is three solid silver circles worn on the right uniform collar.

Lieutenant Commander

Flag Officers of Lieutenant Commander rank function as assistant department heads or specialists. Senior Bridge Officers in charge of specific watch commands are usually Lieutenant Commanders. In vessels of Class V or below, a Lieutenant Commander is frequently assigned as First Officer to a ship's Captain of Commander rank. Staff officers of Lieutenant Commander grade serve as aides to senior officers and may, on occasion, represent their superiors on special assignments away from normal duty stations.

The insignia for Lieutenant Commander is two solid silver circles and one hollow silver circle worn on the right uniform collar.



LIEUTENANT COMMANDER

Lieutenant

Lieutenants serve on Bridge command crews and as specialists aboard ship. In the absence of senior officers, Lieutenants also command special Away Teams off-ship. Away from the Bridge, Lieutenants serve as assistant department heads. On star bases and ground installations, Lieutenants are in charge of specific duty stations, generally supervising from three to twelve junior officers and enlisted men.

The insignia for Lieutenant is two solid silver circles worn on the right uniform collar.



LIEUTENANT

Lieutenant (Junior Grade)

Junior Grade Lieutenants aboard ship are responsible for the direct operation of non-bridge duty stations under the supervision of senior personnel. Bridge operations involving Navigation and Helm Control are also assigned to Lieutenants Junior Grade under the supervision of senior officers. On ground installations, Junior Grade Lieutenants typically act as station-keepers under the direction of a Senior Lieutenant.

The insignia for Lieutenant j.g. is one solid silver and one hollow silver circle worn on the right uniform collar.



LIEUTENANT (JUNIOR GRADE)

Ensign

Ensigns serve as junior officers in a variety of duty stations both aboard ship and at star base and ground installations.

The insignia for Ensign is one solid silver circle worn on the right uniform collar.



ENSIGN

Ensign (Junior Grade)

As the lowest-grade officers in Starfleet, Junior Grade Ensigns are usually recent graduates of Starfleet Academy, and serve as technical and administrative assistants. In rare cases, a civilian may receive the honorary rank of Ensign Junior Grade to coordinate enlisted personnel aboard ship for a limited duration.

The insignia for Ensign (Junior Grade) is one hollow silver circle worn on the right uniform collar.

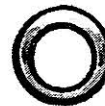

ENSIGN (JUNIOR GRADE)

Midshipman

Midshipmen are recent graduates of Starfleet Academy who have completed their final cadet cruises. These officers are typically assigned duties as junior aides to line officers in either the technical or scientific branches of Starfleet. Midshipmen may also be assistants to officers in foreign legations and administrative officers. Such assignments are typically between 6 and 18 months in duration, after which promotion is routine.

The insignia for Midshipman is a single solid silver sunburst worn on the right uniform lapel.

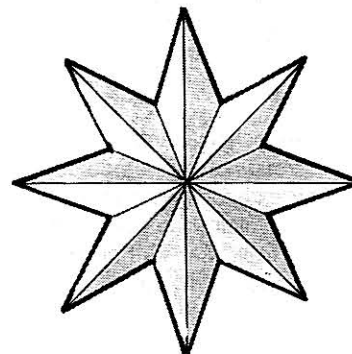

MIDSHIPMAN

ENLISTED MEN

Recruit

Recruits may enter Starfleet at the age of 18 (or age 17 if their first assignment is to a colony world or other non-ship posting). Recruits undergo extensive training and orientation in Starfleet and Federation life for 18 months at induction centers located on various worlds. Then they receive six months of specialized training appropriate to each individual's potential and cultural background.

The insignia for Recruit is a plain, one-piece white uniform design with no decoration except for the standard bio-communicator pin.

Specialist

These junior-level enlisted personnel make up the majority of all branch team members serving aboard ships and in Starfleet ground installations. Responsible for carrying out routine, day-to-day assignments, Specialists can serve either with members of their own branch classification or with other branches for cross-training.

The insignia for Specialist is a plain, one-piece uniform of the standard SD1 pattern, according to service branch, with standard bio-communicator pin and a hollow brass diamond worn on the right and left wrist cuffs.

Specialist Second Class

Second Class Specialists are individuals who have demonstrated leadership and technical competence in a given area of operations. "Spec Twos" may command four to ten junior specialists, depending on individual duty assignments.

The insignia for Specialist Second Class is a plain, one-piece uniform of the standard SD1 pattern, according to skill service branch, with standard bio-communicator pin and a solid brass diamond worn on the right and left wrist cuffs.

Specialist First Class

Specialist First Class grades are enlisted personnel whose competence and leadership are sufficient to permit them independent control of Junior Specialists without direct supervision by officers.

The insignia for Specialist First Class is a plain, one-piece uniform of the standard SD1 pattern, according to skill service branch, with standard bio-communicator pin and one solid and one hollow brass diamond worn on the right and left wrist cuffs.

Chief Specialist

Chief Specialists have advanced technical and administrative skills and can command large groups of enlisted personnel without other officers' supervision for extended periods of time.

The insignia for Chief Specialist is a plain, one-piece uniform of the standard SD1 pattern, according to skill service branch, with standard bio-communicator pin and two solid brass diamonds worn on the right and left wrist cuffs.

Petty Officer

This rank is given to non-commissioned officers who have shown exceptional leadership in their own areas. A Petty Officer typically commands a group of enlisted personnel, often independent of direct supervision by junior officer grades.

The insignia for Petty Officer is up to three hollow gold circles worn on the right uniform lapel, denoting Petty Officer, Petty Officer First Class, and Chief Petty Officer.

WARRANT OFFICERS

Non-commissioned officers who have displayed exceptional expertise in technical or mechanical areas are awarded this rank. Warrant Officers typically command a group of enlisted personnel who act as technical assistants answerable only to the Warrant Officer.

The insignia designation for Warrant Officer is either one, two, or three solid gold rectangles worn on the right uniform collar to indicate Warrant Officer, Warrant Officer First Class, and Master Warrant Officer.

NEW STARFLEET OFFICER POSITIONS

In recent years, Starfleet has made changes in duty assignments to reflect a range of new responsibilities. These changes, the new position designations, and the resulting new ranking structure are described in this section.

BRIDGE COMMAND SPECIALIST

Starfleet has extensively modified its traditional training of bridge personnel to respond to the need for specialists who can handle more than one area of responsibility in an emergency. The result is the elimination of the traditional Helm, Navigation, and Communication positions aboard ships of Class V and above. Instead, Bridge crews are now composed of Bridge Command Specialists, who are cross-trained in the areas of Helm, Navigation, Weapons, Communications, and Engineering. In an emergency, a Bridge Command Specialist can assume the duties of any Bridge position, avoiding the loss of precious time that would be needed to summon an off-duty, single-task crew member.

SHIP'S COUNSELOR

After contact with the Betazoids, the intelligent humanoid race of Haven II, and the subsequent admission of Haven as an associate member of the Federation, it became clear that this race of intelligent empaths had a unique contribution to make to the Federation. Betazoids can detect emotions and motives over distance without prior contact with an alien race. Given the importance of establishing good relations with intelligent life forms on first contact, the Haven Accord of Stardate 4/18 mandated that members of the Betazoid race gradually be integrated into the staff of Federation exploration craft of Class V and above.

These Betazoids hold the unique position of Ship's Counselor, which carries the honorary rank of Commander, though the Betazoids are not normally placed within the ship's chain of command. The function of the Ship's Counselor is to provide command officers with accurate assessments of the motives, emotional needs and desires, general psychological stability, and overall level of rational behavior of alien life forms.

Though a Ship's Counselor cannot decide policy, he often plays a crucial role in negotiating treaties or in situations involving potentially hostile forces. In addition, the Betazoid's ability to read the surface thoughts of a nearby individual occasionally helps medical personnel deal with cases of extreme emotional disorder.

SHIP'S CREWMASTER

With the changing social structure aboard larger Starfleet vessels—especially the new *Galaxy* exploration class—ship companies now are also responsible for multiple family groups over long periods of time. To meet this contingency, Star Fleet has created a new ship position, that of Crewmaster, with the rank of Lieutenant Commander. The Crewmaster is responsible for social interaction between the ship's civilian population and crew members. He is charged with the training and educational needs of civilians, maintaining peace among diverse civilian groups, moderating a variety of alien social customs, and the general welfare of all civilian family members. Aboard a *Galaxy* Class exploration ship, a Crewmaster is aided by an Assistant Crewmaster holding the rank of Lieutenant, six civilian training supervisors, and four civilian cultural specialists.

STARSHIP SYSTEMS SPECIALIST

Scientific discoveries in the last quarter-century have required that technical experts work closely with Starfleet personnel, either aboard ship or on special assignments, such as engine modifications, implementation of new weaponry, or computer upgrades. Civilians holding the position of Systems Specialist receive a nominal commission in Starfleet equivalent to either Commander or Lieutenant Commander. Systems Specialists work closely with ship and base personnel in specific areas of expertise and do not otherwise fall within the chain of command.

STARFLEET TACTICAL OFFICER

The Tactical Command Officer (Tac Officer) is responsible for all defensive operations at a star base or ground installation. Reporting directly to the Base Commander, the Tac Officer controls the armaments, personnel deployment, weapons research, deflector shield operations, and all other operations required for defense.

STARSHIP CHAIN OF COMMAND

Reflecting the changes in ranking and branch positions within Starfleet over the last several decades, the chain of command aboard Federation starships has also been modified to incorporate new responsibilities and new positions, both civilian and military. The typical chain of command aboard a Federation starship appears below.

CAREER OPPORTUNITIES

Though nearly every graduate of Starfleet Academy dreams of commanding a starship, this privilege falls only to the few, and these are the best there are. Below the rank of Captain, however, opportunities abound for personal fulfillment and creative work. As a member of a Cultural Exchange Team, a senior officer can play a decisive role as a representative of the Federation to newly discovered races. As part of a Federation Economic Assistance Team, an officer can help strengthen economic systems on dozens of newly colonized worlds. As delegates to Federation member worlds, officers with administrative and diplomatic expertise can influence the decisions of planetary systems. By heading training programs, cultural exchanges, social and economic trade fairs, or by administering Starfleet facilities on alien worlds, officers can help strengthen the Federation. As Science Advisers, Starfleet officers can make it possible to feed thousands where none could have been fed before.

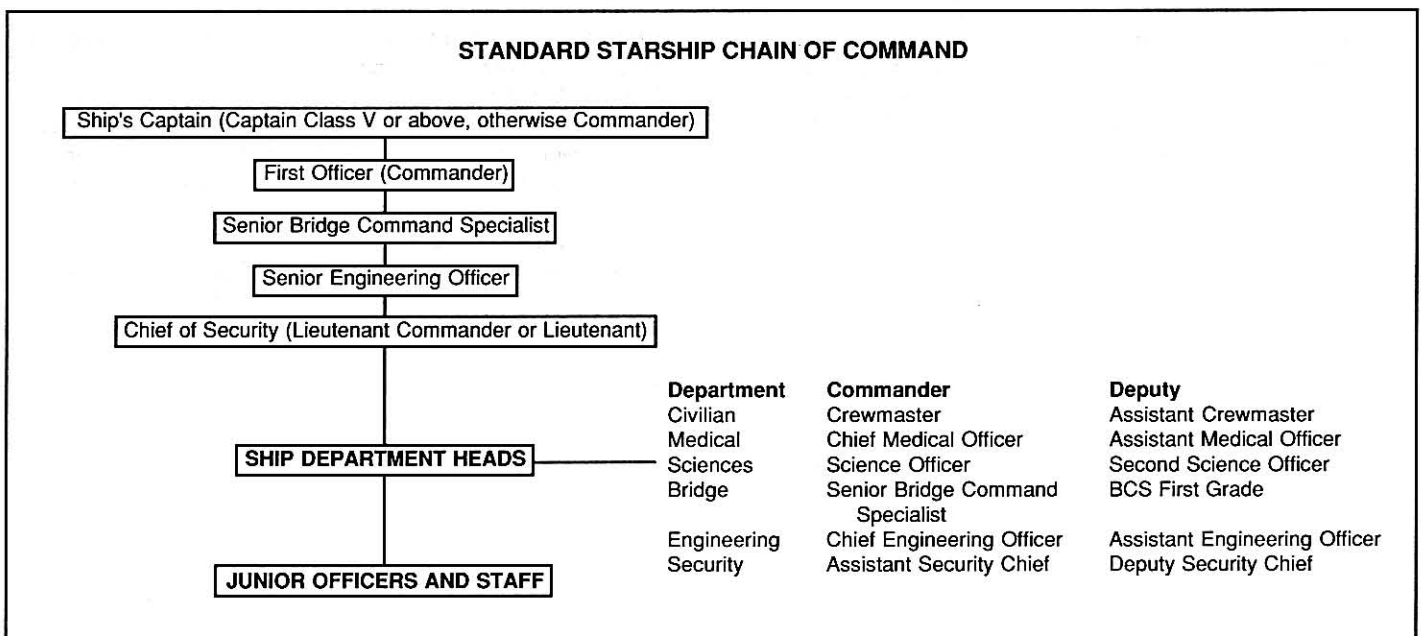

POST-ACADEMY TRAINING

For a career officer, training does not stop with graduation from Starfleet Academy. The continuing expansion of the Federation and technological advances require officers to train continually to improve skills and acquire new ones. Every five years, Starfleet officers must undergo a six-month skills evaluation. During that time, some officers are sent to major universities throughout the Federation for advanced courses in engineering, astrophysics, planetary sciences, mathematics, and so on. In addition, promising officers may be selected for training at one of the several postgraduate training schools described below.

Starfleet Staff College

Officers aspiring to a command position beyond the rank of Captain must complete a six-month training class at Starfleet Staff College. In addition to improving his administrative skills, an officer will study the administrative structures of Starfleet and the Grand Alliance to understand matters such as funding the fleet in peacetime, civil-military relations, and appropriations for scientific research.

An officer also receives training in the responsibilities required of a member of an Admiral's planning and preparations board.

Starfleet Tactical College

To command a vessel, an officer must pass the rigid requirements of Star Fleet Tactical College. Here the officer studies the latest developments in Starfleet combat capabilities as well as advances by foreign governments. Some of the finest tacticians in the fleet instruct officers on specific tactical options drawn from actual combat situations, on new fleet tactics for either single- or multi-ship combat, on the coordination of ground forces, and on defending ground installations from orbital attack.

Starfleet Strategic Studies School

Officers nominated for promotion to the rank of Sector Admiral must complete a year-long course at Starfleet Strategic Studies School. Candidates study the deployment of strategic resources, galaxy-wide Starfleet operations, avoiding unwanted conflicts, refugee relocations, and civil disorders.

Starfleet Intelligence School

Each year, the Fleet Commander invites 100 officers to enter Starfleet Intelligence School. Selected officers are exposed to the latest developments in espionage as well as to the nature and scope of clandestine operations.

PEACETIME POSITIONS

Though times of interstellar conflict offer aspiring officers the most opportunities for advancement, it is fortunate that such periods are rare. During peacetime, Starfleet officers may hold a variety of planetside positions that can lead to similar, if slower, advancement to senior grades. Some of the more coveted of these positions are described in this section.

Provost Marshal

A Starfleet Provost Marshal is responsible for maintaining order on an entire planet or occasionally in a whole solar system. The Provost Marshal has the authority to implement the regulations necessary for the common welfare, to enforce Federation laws, and to impose penalties or sentences on civilian or military personnel.

Legation Commander

As duty officer for the Federation Diplomatic Corps, a Legation Commander is responsible for the security of all Federation diplomatic missions. A Legation Commander is also responsible for the well-being of all civilian and military diplomatic representatives and their support personnel.

Ambassadorial Aide

A Federation ambassador may require the services of one or more Starfleet personnel for advice on highly scientific or technical subjects. In such cases, Starfleet officers with the appropriate expertise are assigned as Aides to the ambassadorial delegation.

Instructor, Starfleet Academy

The need to maintain high standards at Starfleet Academy means that only the most skilled officers are assigned to the prestigious position of Instructor.

Education Officer

The Education Officer is posted on a Federation member-planet to supervise Starfleet training programs involving the integration of new races, to evaluate prospective Academy cadets, and to administer educational programs aimed at improving civil-Starfleet Relations.

Cultural Attache

Officers serving as Cultural Attaches assist senior personnel in maintaining good relations between Starfleet personnel and the indigenous planetary population.

Science Attache

Science Attache Officers provide Starfleet technology to civilian scientists conducting specific research that might involve medicine, archeology, physical sciences, space science, or other scientific disciplines.

Administrative Officer

An Administrative Officer maintains files on Starfleet service personnel and members of the civilian population in the employ of Starfleet Command.

RECRUITMENT GUIDELINES AND PRIVILEGES

Though the conditions of recruitment to Starfleet may vary slightly from planet to planet, the Alliance established a uniform standard in revised regulations effective Stardate 3/0001.15. These guidelines guarantee all recruits the conditions and privileges described below.

PAY RATES

A standard pay scale has been established without regard for branch. These rates are listed elsewhere in this manual. Disbursement is guaranteed at any base installation. Individuals engaged in deep-space exploration or other hazardous duty receive double pay.

LEAVE TIME

After the first year of duty, each recruit receives two weeks' leave. Thereafter, personnel get one additional week for every two years in service. Free leave transportation is available via Starfleet or commercial transport.

FAMILY UNITY

Every effort is made to prevent the separation of Starfleet personnel from their families for long periods of time, except in cases of emergency or hostilities. Starfleet also provides for dependents, including transportation on Starfleet vessels.

EDUCATION

Starfleet personnel and their families may receive free education through one of several programs established at universities and colleges throughout the Federation.

RETIREMENT

If Starfleet Enlisted personnel re-enlist after the initial four-year tour of duty, they receive retirement benefits as specified by set percentage rates of current base pay. Similar provisions are made for officers, based on time in grade and rank at the time of retirement.

MEDICAL CARE

All Starfleet personnel and their families are guaranteed free medical, dental, and mental health care, either aboard ship or at star base sick bay facilities.

THE GREATEST ADVENTURE IN THE GALAXY

TO: All Starfleet Recruitment Offices

FROM: Commandant, Star Fleet Academy

As a galaxy-wide public service to Federation worlds, Starfleet Academy has set forth a list of requirements for future applicants. It is hoped that this document will clear up confusion and answer the most commonly asked questions.

Starfleet Academy Application Criteria

In order to apply for Starfleet Academy, an individual must meet the following criteria:

1. The applicant must be native to a full-member Federation world or a colony of a full-member planet.
2. The applicant must be sponsored by one of the following: a Starfleet officer above Lieutenant rank, a member of the Federation Council, an ambassador of a Federation world, a governing body of a planet, or a member of the Federation Science or Medical Council.
3. The applicant must be a sentient being. Starfleet does not discriminate on the basis of race, age, color, gender, political, social, religious, or financial status. An artificial being may apply to the Academy if it possesses sentience and passes a battery of psychological tests.
4. The applicant's physiology must not be harmful toward other sentient beings. This condition may be waived, however, if scientists from the applicant's planet can furnish a working containment system as well as extensive proof of its reliability.

Having fulfilled all the above requirements, the applicant must turn in his application to the local Federation facility by the end of the third month of the current solar year.

The Starfleet Selection Board reviews all applications, and will notify all approved applicants within 90 solar days of initial application date. Notification of approval also contains the time and place of the entrance exam.

Starfleet Academy Entrance Exam

The Starfleet Academy entrance exam takes place once each solar year on every Federation planet. In cases where the applicant lives in space, he or she may take the test at the nearest Federation world. The applicant requires a written deposition from the commander of the space facility or vessel confirming the applicant's spacebound status.

In addition to other quotas, Starfleet chooses one applicant from each member planet, except the First Five worlds of Terra, Andor, Vulcan, Tellar, and Alpha Centauri, which supply a dozen each.

In cases where a spacebound applicant's test scores match those of the highest score of a planet's native applicant, both will be admitted.

Applicants can take the test only once in a year. To ensure fairness, the test contents change every year.

The written and oral portions of the exam test the applicant's knowledge of history, sciences, astrology, and mathematics, as well as his ability to solve logic problems, computer-generated problems, and ethical questions.

Physical skills are tested to prove that the applicant meets the highest ratings within the parameters of his race.

Finally, there are psychological tests. The first series of tests measures the subject's stability in relation to his or her race. (Obviously, an Izaran would test as more aggressive than would, say, a Caitian.) These exams can be quite grueling, testing such areas as reflexes, imagination, adaptability, and morality. The second part is even tougher. Using holographic images, past incidents in the subject's life, and outright trickery, the applicant's persona is tested to the breaking point, usually in confrontation with his or her worst fear.

Those who are not intimidated by these criteria or the idea of leaving the safety and comfort of their world may be ideal applicants to join in the greatest adventure in the galaxy.

DEATH BENEFITS

If a member of Starfleet is killed in the line of duty, the individual's next of kin receives three-quarters of the individual's pay for life as well as a standard 100,000-credit service honorarium from the United Federation of Planets to aid in the support of survivors.

DISABILITY BENEFITS

Any member of Starfleet disabled in the line of duty shall receive half-pay monthly, in addition to a standard 50,000-credit service honorarium from the United Federation of Planets.

SEVERANCE PAY

Individuals with ten years of service who do not wish to remain with Starfleet shall receive 5,000-credit payments from Starfleet Command to aid in establishing a new civilian career.

REENLISTMENT BONUS (ENLISTED PERSONNEL ONLY)

After the initial four-year tour of duty, enlisted personnel who continue in the service shall receive a reenlistment bonus of 6,000 credits. Further reenlistments earn a bonus of 1,000 credits per year of service.

TRAVEL GUARANTEE

Except in times of war or other emergency, Starfleet personnel are guaranteed reassignment to a new duty station at least once every two years if so desired.

CLOTHING (ENLISTED PERSONNEL ONLY)

Starfleet Command provides free clothing for current duty personnel during their tour of service.

SPACE SERVICE

Unless prevented by war or emergency, Starfleet personnel are guaranteed at least two years of space duty for every five years of active service.

ENLISTED PERSONNEL TRAINING

Unlike the integrated training procedures at Starfleet Academy, enlisted personnel receive education in their primary skill areas only. Recruits receive training along one of two tracks, either shipboard or ground service. These programs are referred to as Enlisted Preferred and Enlisted Basic.

ENLISTED PREFERRED PROGRAM

Individuals qualified for shipboard service receive three years of rigid supervision at the Starfleet Enlisted Personnel School on Deneva. During the first year of training, personnel undergo a tough regimen of physical and psychological conditioning in preparation for shipboard duties, including familiarization with standard Federation equipment. During the second year, the recruit receives advanced training at a Specialist Center. Every effort is made to match Starfleet's needs with individual preferences. The special installations are:

Starfleet Science Center (Vulcan)
Starfleet Security Services Training Center (Andor)
Starfleet Engineering and Operations School (Terra)
Starfleet Medical Training Command Center (Tellar)
Starfleet Communications Systems Training School (Alpha Centauri)
Starfleet Navigation School (New Paris)
Starfleet Helm Operations School (Stratos)
Starfleet Weapons Training Center (Argelius)
Starfleet Administration Training Center (Troyus)

During the last year of training, each enlisted recruit receives advanced specialty training in shuttlecraft and small systems operation as well as detached training with fleet personnel on site. After an on-site evaluation, each individual receives six weeks' leave and then a posting.

ENLISTED BASIC PROGRAM

About 70 percent of Starfleet's personnel enter Enlisted Basic programs. This program is a rigorous, one-year regimen of physical and classroom training. During this year, recruits get in shape, learn weapons skills and tactics, and assimilate as much as possible of what is taught in Starfleet Academy's four-year curriculum. The program has a high failure rate.

PROMOTION GUIDELINES

The following guidelines outline the conditions for promotion in either enlisted or officer ranks.

1. Promotion shall be tendered to any individual who has completed four years of duty since his last promotion became effective, unless the commanding officer disapproves.

2. An individual may be promoted to fulfill the duties of a senior officer. Upon the arrival of senior command personnel, this temporary (brevet) rank may be either rescinded or made permanent, at the discretion of the commanding officer.

3. Individuals may be promoted one or more steps in grade because of heroism or gallantry under conditions of emergency or war status. Awarded at the discretion of the senior commanding officer present, such promotions take full effect immediately.

4. Promotions above the rank of Commodore must be approved by the Commander of Starfleet Personnel.

5. The commander of Starfleet shall authorize promotions that are in the best interests of the fleet. All promotions above the rank of Captain shall be reviewed by the Secretary of the Office of Starfleet at three-year intervals. The Federation High Council charges the Secretary with either confirming or revoking such promotions.

6. The President of the Federation is empowered to make promotions in the best interests of the Federation, with the approval of the Starfleet Commander. In the event of disagreement between the President and Commander, a special panel of six individuals, three from the ranks of Starfleet Command personnel and three members of the Federation Council, at random, will adjudicate the matter. If no resolution is possible, the Secretary of the Office of Starfleet shall make the final decision.

INTEGRATING NEW RACES

One of the more complex and challenging problems facing Starfleet Command is the integration of new races into the mainstream of the Federation. The admission of new races into Starfleet Academy has increased the importance of proper placement of different racial types.

RAPID INTEGRATION PROGRAM

In the course of the Galaxy Exploration Command's missions, Starfleet personnel encounter many races. Many of these races have asked for and been granted membership in the UFP. Sometimes these races had already mastered faster-than-light space travel and had their own fleets of vessels and trained personnel to crew them.

A problem arose when members of these other militaries wished to join Starfleet. Should one of these experienced officers of a new UFP member race have to attend Starfleet Academy for four years, followed by a cadet cruise, department head school, and command school?

It seemed rather ridiculous for an officer from a new member's fleet to "start from scratch," yet it seemed dangerous to arbitrarily assign such officers, inexperienced in Starfleet's procedures, to Federation starships.

To solve the problem, Starfleet created the New Spacefaring Members Accelerated Training, Evaluation, and Rapid Integration Program. A prospective applicant takes a series of tests known as the Starfleet Academy Equivalency Batteries to determine his technical knowledge and skills and to measure any gaps that would have to be filled in before the individual could function adequately in Starfleet.

Depending on how close the race's standards are to Starfleet's, the applicant is enrolled in a one- or two-year program that brings him up to date on Starfleet and the Federation.

Since RIP began in Stardate 2/2203, with the Ighresh and the Ulthairians as the "test cases," the program has accommodated the needs of 43 new races, and has incorporated them smoothly into Starfleet's structure. Some officers have even been able to carry over their former ranks into Starfleet. Thus far, RIP is an undisputed success.

IMPRESSIONS OF RIP

[The following essay was written by an Ighresh Naval officer who entered Starfleet's Rapid Integration Program. His assignment was to explain his impressions of RIP training to his commanding officer, as though the officer had never heard of RIP before. As part of his training, the Ighresh had to compose his account in Galacta, which explains some minor problems in syntax.]

My involvement in this most wonderful RIP program came about since an officer I was in the Ighresh Naval fleet. It was my wish Starfleet to join, but it was not my lust to start off in the toilet. I wished to keeping of old rank.

Humans divide day/night into 24 units. Real dumb. We wake up one 24th of a day before the major star that supplies daylight comes up over the horizon. Then we have the runs for great distances, but this I do not have amorous feelings toward because I do not have Human-type things to propel me across a planet's dirt. We have runs for 8 kilograms.

Then comes nourishment. Humans and others with weird appendages called legs eat strange food. They stick food into wide openings located near their pinnacle. This wide opening is where their sounds come from. Unlike Ighresh, they cannot talk while applying food to front face.

After nourishment, we have classes. This is my part that I have a crush on. We learn much of the Federation, including how many ships they tossed together, and how many people they terminated the lives of.

We learn to talk like rest of Federation, using Galacta, but this difficult. Ighresh have no front openings to stick food and make sounds. We need usage of tentacles moving through atmosphere creating vibrations for speech. Many races that fly through space and just join the Federation need learn Galacta so they can communicate to rest of Federation. This one is having personal problems with Galacta, but it is slowly recuperating from mistakes made at start.

But the science we get is the most grandiose of all true facts. We learn more than usual space cadet, because a lot of catching on we need to do. RIP lasts for one orbit of planetary body around primary star. We mash four orbital units of Academy into one orbital unit.

Because Ighresh can already travel to stars and such, RIP need not tell us the already known junk. They throw on our heads much nouns and verbs telling about the Starfleet way of killing or talking to someone.

One day, big boss officer brings six of us to Star Fleet ship. (Starfleet ships are weird. Not alive, like ours!) He shows us a taken-apart warped engine and he tells us to put engine together. This is a test and we have four 24ths of a day cycle to do so. Real violent thing!

They also do things of surprise like come in the middle of night cycle and pretend to be enemies attacking our rooms. Silly! Why would enemies want to attack beds?

Humans actually have need to sleep equal to eight 24ths of a day! This unbelievable thing by me! So much time for rest! I was in not-sleep way and I hear the fake enemies coming. Such fun. They want I should use hand-to-hand combat, but many times I tell them: Ighresh have no hands! Such a big funny laugh-joke! Maybe I should use tentacle-to-hand combat?

One day they even drop us on a planet...no nourishment, no liquid, no machines, no warning! Survive, they tell us, for three revolutionaries of the planet. To survive was no problem for this one. My system easily able to go on without outside fluids and nourishment for seven revolutionaries. Other cadets not do so nicely. I try to give them some of this one's fluids. They turn green and run away screaming.

In anyhow, RIP is tough entity to go through. It bestest than other trainings, even Ighresh navy! Very nasty and learn lots of true facts, more than ever possible. Tomorrow, we go through false crisis involving Prime Directive. Should be horrifying and rough. Now, could only Starfleet teach its ships to grow and talk like do Ighresh ships!

The following brief summaries indicate the progress and problems involved with various races.

Ariolo

Mammalian creatures with a vague resemblance to centaurs of early Terran mythology, the pacifistic Ariolo have recently made significant contributions to the Federation in a variety of nonmilitary areas. Members of this race excel in administration, and so almost all Starfleet installations or star bases now have at least one Ariolo on their planning staffs. The characteristic Ariolo love of harmony and organization has similarly distinguished the race in the areas of music and the fine arts. Many Federation cultural exchange programs feature Ariolian works of art as examples of what inter-species cooperation can accomplish.

Arkenites

An aquatic race that has evolved into an air-breathing civilization, the Arkenites are now a permanent fixture in Federation society, and many Arkenites serve on Starfleet science and exploration vessels. Because their physiology makes them sensitive to planetary magnetic fields and seismic disturbances, Arkenites are born geologists. Members of the race also serve in positions involving physical and astronomical sciences. They rarely take offense and can live comfortably with other species, which makes them ideal for long-term assignments in confining or isolated conditions. Due to a quirk in Arkenite psychology, few Arkenites have risen to command rank in Starfleet, with most preferring advisory or subordinate positions.

Betazoids

Humanoids from the planet Haven, Betazoids are known for their telepathic and empathic abilities, which have proven to be the race's greatest asset and its biggest stumbling block in dealing with many Federation races. Because the controlled use of these talents is so advantageous, Starfleet Command has taken the unprecedented step of creating the position of Ship's Counselor, which will become mandatory on all new vessels and will be filled by Betazoid officers. Many Federation personnel resent the inclusion of Betazoids among them, however, fearing that the empaths will invade their privacy. A wave of protests has limited the admittance of Betazoids to Starfleet Academy. Only time will tell whether Starfleet officers will one day serve willingly alongside Betazoid personnel.

Deltans

For many years, some of the most prized members of any Starfleet or ground crew were members of the Deltan race. Because the biochemical agents in the Deltan metabolism act as a massive sexual stimulant to other humanoids, however, problems have developed because many Deltans object to Starfleet's oath of celibacy. In search of a solution to this growing problem, Delta has been clamoring for Starfleet to provide starships with all-Deltan crews. Starfleet has refused to meet the Deltan demands, which only increases the tensions. Aside from this issue, Deltans make excellent officers.

Efrosians

Since their admission to the Federation several decades ago, Efrosians have become one of the pillars of the Starfleet command structure. Efrosian Medical, Helm, and Navigation Officers have served for years as vital members of starship crews. Because of their special abilities in these areas, the Efrosians have been in the forefront of opposition to streamlining Academy training procedures through the introduction of the Integrated

Officer concept. Many Efrosians object to being asked to "dilute" their talents by learning several skills. Other races have speculated that this may also run counter to Efrosian social or religious conventions, about which little is known. Many Efrosians object to other races' "prying". The secrecy surrounding Efrosian religious rites continues to fuel speculation of depravity and unwholesome acts, which the Efrosians vehemently deny. With no resolution in sight, Efrosians remain handicapped socially and in their careers.

Klingons

Only a limited number of Klingon officers and enlisted personnel have been incorporated into the ranks of Starfleet Command. With a single exception, these personnel are on temporary assignment and will return to their vessels in the Klingon Defense Force over the next few years. Though Starfleet encourages personnel exchanges with the Free Worlds of Klinzai, the racial prejudice of many Klingon commanders continues to hamper these efforts. Officer exchanges have occurred informally, however, between Klingon and Federation personnel, and these unofficial instances may eventually open the way for a formal arrangement with the Klingon Defense Force.

Medusans

Starfleet has begun an experimental program of integrating Medusan navigators into selected Federation ship companies. Because the appearance of the noncorporeal Medusans can cause insanity in non-Medusans, there must be special arrangements to prevent other Federation personnel from accidental exposure to an unshielded Medusan. Initial reports of success are hopeful, but a full evaluation of this test program is necessary before even limited numbers of Medusans can operate as members of new ship crews.

Xelations

Vaguely humanoid, but with tentacles and a face shield to protect them from normal lighting, the Xelation is becoming a common sight at Federation bases and ground installations. The aquatic Xelations have fit in well with the Starfleet Marines, and there are several Xelation-only aquatic strike teams operating in conjunction with humanoid counterparts on dozens of Federation water worlds. With their dry sense of humor and eagerness to experience the new, the Xelations have also found a niche in the Federation Diplomatic Corps; because they are slow to anger and show great patience as negotiators, Xelations have negotiated several important diplomatic treaties in recent years.

Zaranites

Zaranites, who wear protective suits, have won respect for their skill as warriors and weapons technicians. Since their admission to the Federation several decades ago, the Zaranites have established themselves in the forefront of advanced weapons research. Indeed, Zaranite research produced the advanced form of collimator-phaser fire systems employed on the new *Galaxy Class* cruiser as well as Starfleet's new plasma torpedo design. The warlike Zaranite culture also presents its problems. Members of this race take offense at the slightest insult by non-Zaranite crew members, even when the insult is unintentional. Moreover, the Zaranite government continues to press the Federation High Council to establish an all-Zaranite crew starship, a privilege enjoyed by both the Vulcans and Andorians. The request has been refused because of the Zaranite tendency to use force as a first resort in unusual or threatening situations. This matter remains a point of contention between Zaranites and the rest of the Federation.

STARFLEET UNIFORMS

Nothing reflects the evolving nature of Starfleet more graphically than the change in uniform designs. After an interim period of reaction against the standard military look, a compromise uniform design was introduced in Stardate 2/9501 that returned to the traditional blue, gold, and red patterns. Because of changing attitudes toward service dress and a general relaxation of regulations, Starfleet personnel have a choice of two styles of uniform dress, with either one acceptable for standard duty postings.

INTERIM DESIGNS

By Stardate 2/5501, standard Starfleet uniforms had changed as a result of crises between the Federation and various foreign powers as well as because of pressure from Federation pacifists. The resulting design, created on New Paris, had a less "militaristic" appearance. The uniform featured a return to the "traditional" Starfleet V-neck, with its wide branch-colored collar. Worn with this were a basic white blouse, flared trousers, and black service boots. The New Parisian Issues displayed rank in silver braid, with a gold Starfleet emblem on the left breast. As with previous designs, this uniform eventually attracted criticism. Detractors considered the white uniform befitting of civilian contractors and laborers rather than trained specialists.

The New Paris design remained in use until Stardate 2/7206, when pressure from Tellarite, Andorian, and Zaranite leaders became too powerful to ignore. The Alpha Centaurian firm of Lerithan Textiles won the contract for a new uniform. The design featured black trousers and a pullover top. A swath of branch-colored cloth rose up from the left breast in a cut-away design, looping over the left shoulder and down the back diagonally. Red denoted Security, Engineering, Communications, and Support personnel; blue was for Science and Biomedical services; gold was for Command positions, and green for Colonial and Ground Personnel. A silver Star Fleet arrowhead symbol was worn on the left breast, with ranks displayed as sets of circular silver devices underneath. These uniforms are still worn by line officers in many of the more distant reaches of the galaxy.

CURRENT DESIGNS

The current uniform design, introduced in 2/9004, represents minor modifications to the Lerithan Textiles design. The most notable change is a realignment of branch colors, with Security and Engineering now marked in gold rather than red. The red designation for Engineering and Security was a point of irritation and branch rivalry within the fleet, because the red divisions were considered to be second-class officers, menials, and cannon fodder. Placing these branches on equal footing with the important sciences divisions has done much to raise morale in Engineering and Security. The revised branch color-coding system is gold for Engineering, Security, and Sciences; blue for Medical and Support; and red for Command, which now incorporates the old Helm, Navigation, and Communications positions into the new Bridge Command Specialist designation.

OFFICER UNIFORMS

Standard Duty Officer

The standard duty uniform of Starfleet personnel is a close-fitting, full-length, two-tone garment of reinforced plasticene-latex. Standard Duty Uniform Option 1 (SD1) consists of black trousers, matching ankle boots, and a tunic color-coded for the appropriate branch. This is completed by a black shoulder covering with piping of the appropriate branch color. Rank insignia are worn on the right collar. All command personnel are permitted to wear a Mark 1 Phaser as a personal sidearm while on duty station.

Optional Duty Officer

The Standard Duty Uniform Option 2 (SD2) is a short-sleeved, skirted version of SD1. Knee-length boots are worn by female crew members.

Off-Duty Casual

Personnel of all branches may wear a light gray, full-length coverall when off duty. Engineering Specialists and personnel assigned to ground installations often wear a similar garment in an orange or light green color. Otherwise, normal civilian dress is considered acceptable.

Officer's Ceremonial Dress

The Starfleet dress uniform is similar to SD1, but with the addition of a knee-length, wrap-around, two-tone cloak of the wearer's branch color. Mid-calf boots are optional. This uniform can be worn with or without the wearer's decorations, depending on the formality of the occasion.

Cadet and Midshipman

The standard dress uniform for Starfleet Academy is similar to the SD1, except that the colors are black and white, with silver piping for junior cadets and gold piping for senior cadets. Midshipmen adopt the standard SD1 design and color pattern with a single silver sunburst on the right collar.

ENLISTED MEN UNIFORMS

Petty Officer

This design is similar to the standard SD1, except that white is substituted for the branch color to denote current status.

Standard dress for enlisted personnel is a design similar to the SD1 officer's design except that the enlisted uniform is a single cut of cloth with rank insignia displayed on the individual's right and left arm cuffs and in a color indicative of branch designation.

WARRANT OFFICER UNIFORMS

The Warrant Officer's uniform is identical to SD1, with gray as the branch color.

NOTE ON PERSONAL COMMUNICATORS

Recent developments in microengineering have permitted significant redesign of the personal signaling device used by Starfleet personnel. In place of the bulky, hand-held communicator, today's model is in the shape of a standard Starfleet "Enterprise Arrowhead" design set against a planetary disk. The new communicator badge acts as a combination biosensor scanner and communicator. The gold alloy of this device acts as a conductor, while the base of the fleet insignia badge provides a constant readout of individual life signs via microwave relay to the ship's computer.

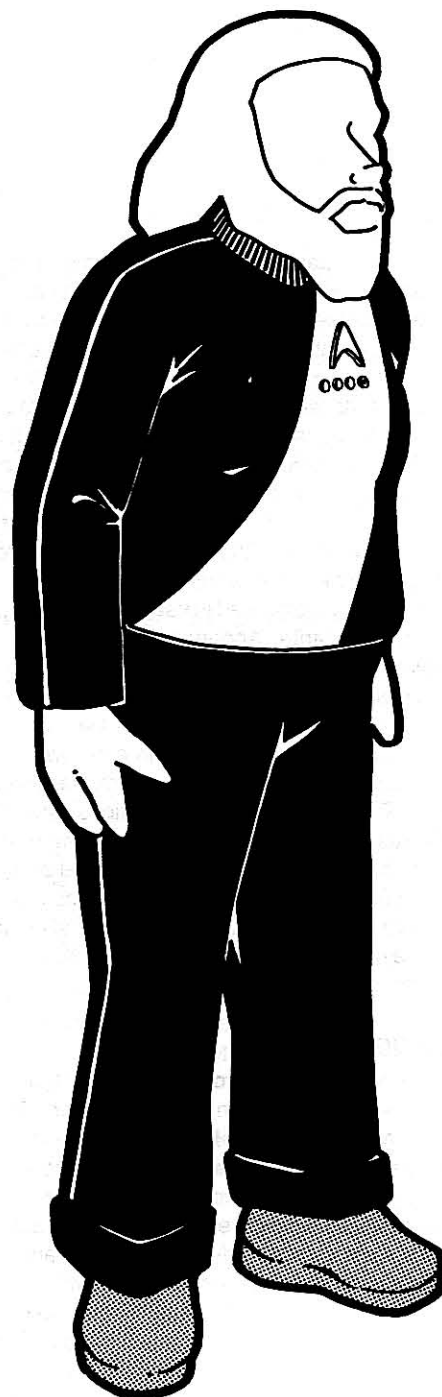
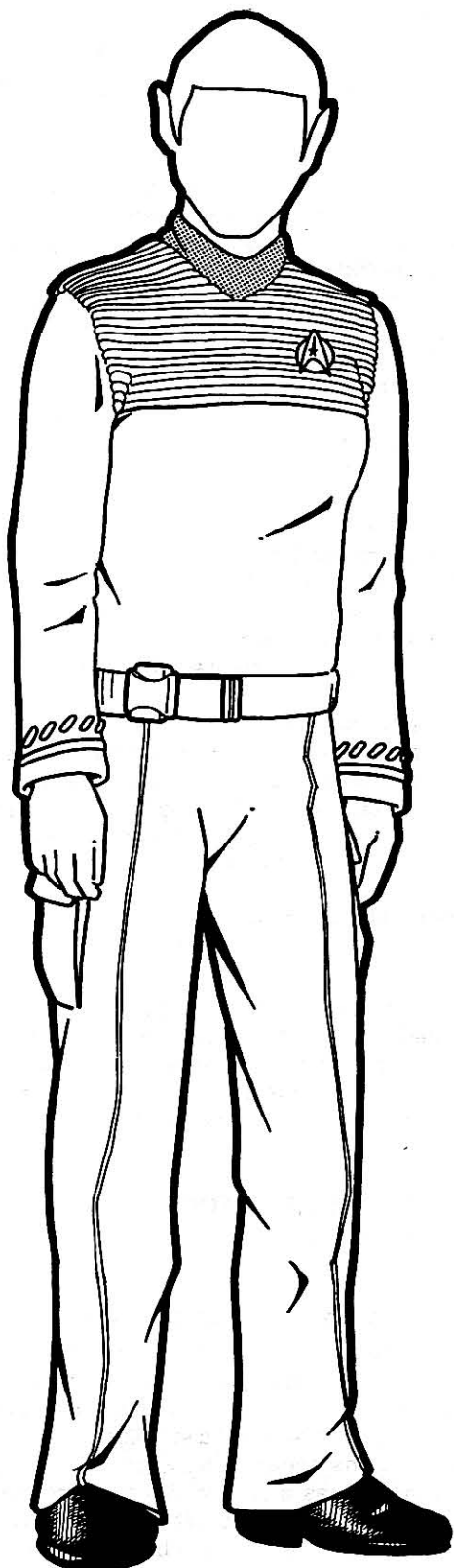

INTERIM DESIGNS

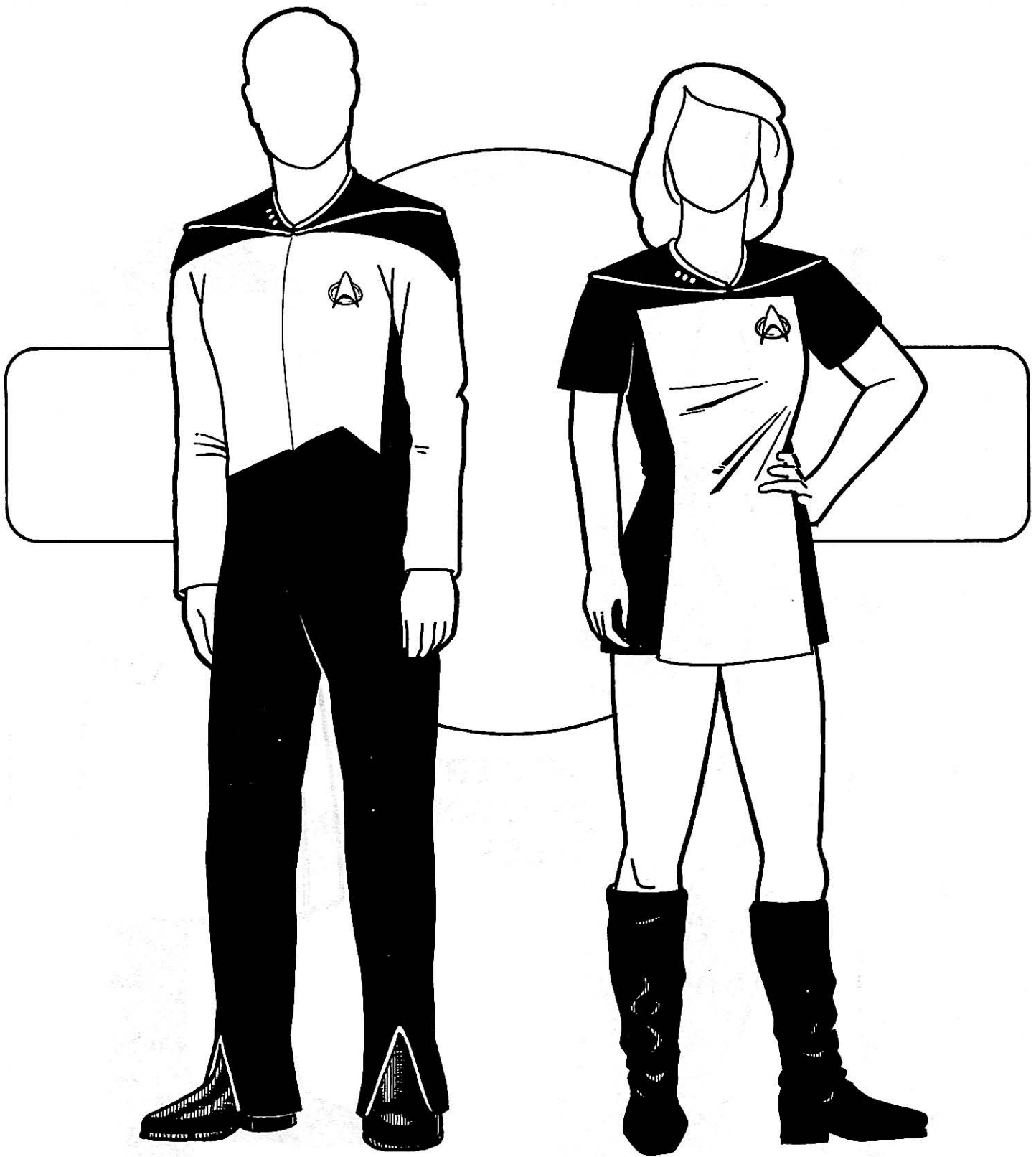

STANDARD DUTY OFFICER

OPTIONAL DUTY OFFICER

OFF-DUTY CASUAL

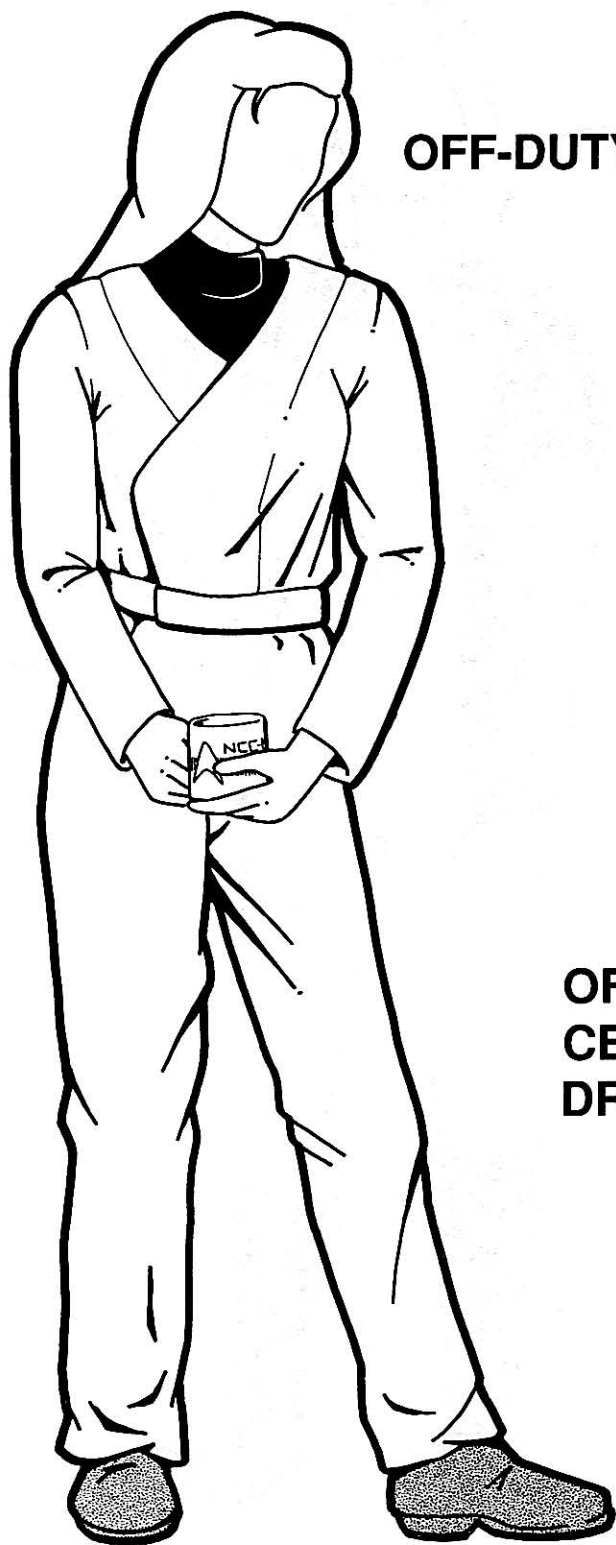

OFFICER'S
CEREMONIAL
DRESS

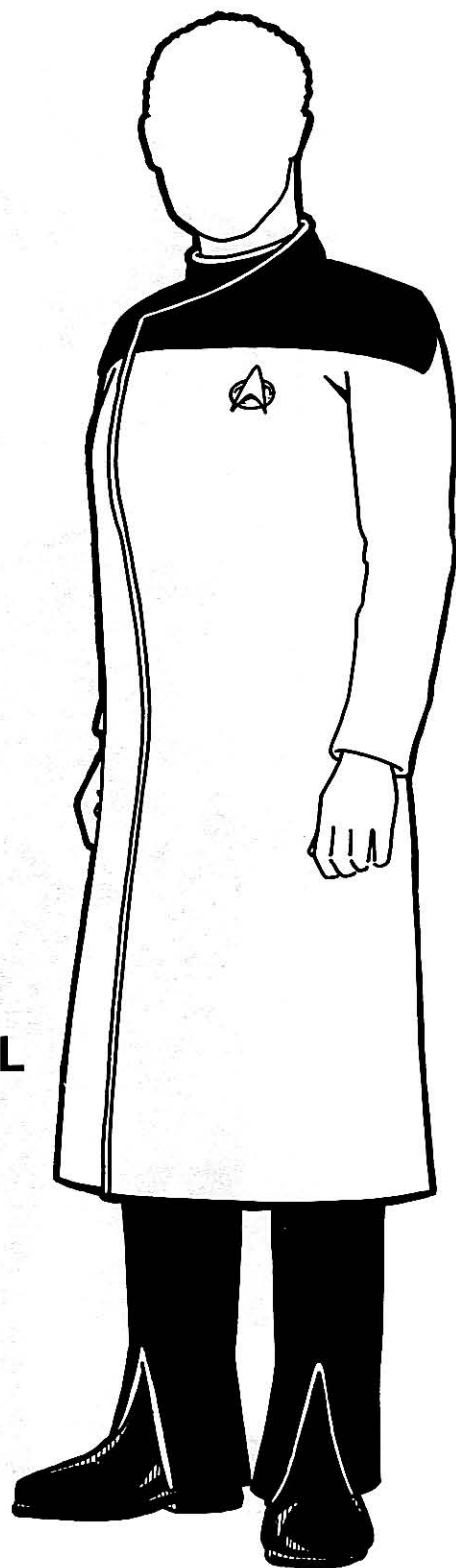

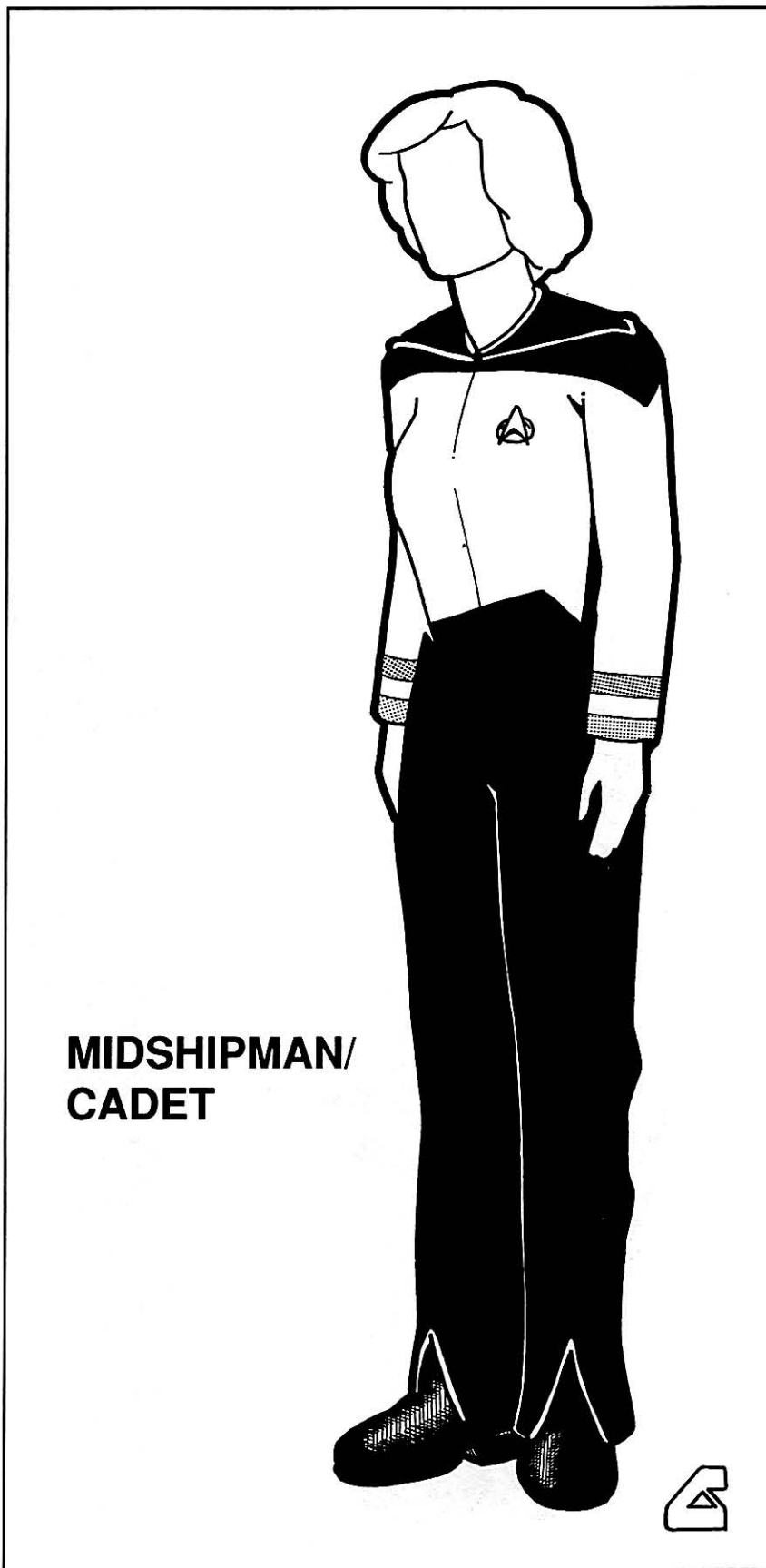

**MIDSHIPMAN/
CADET**



ENLISTED DRESS
UNIFORM



PETTY
OFFICER

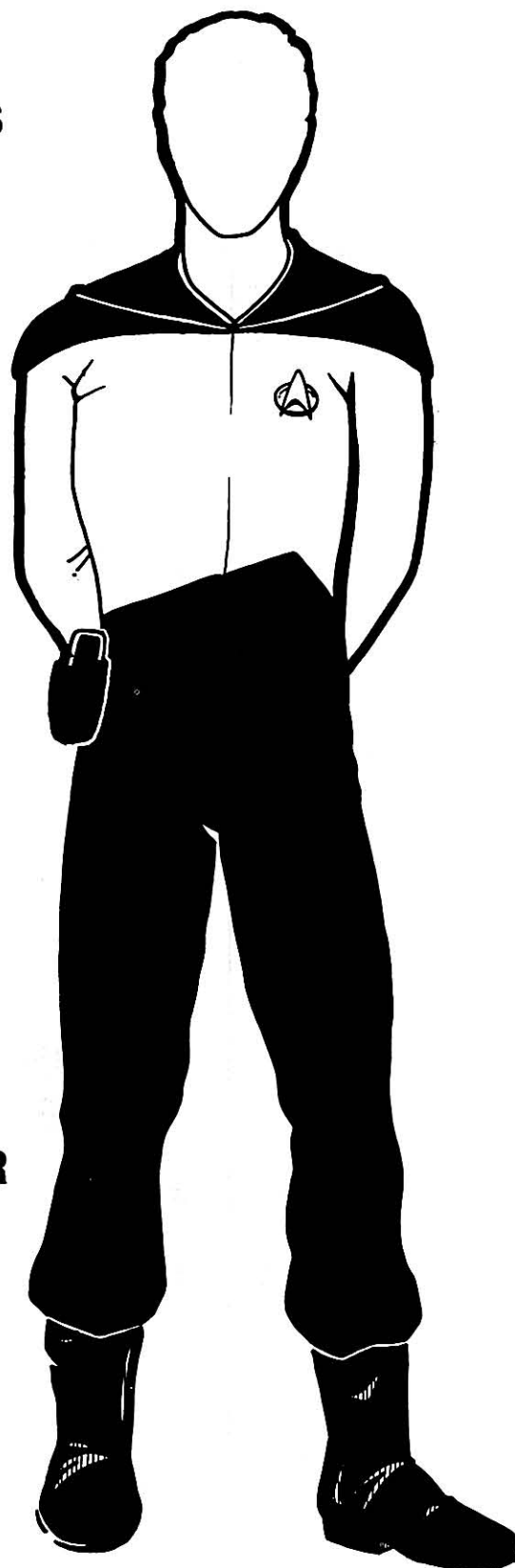

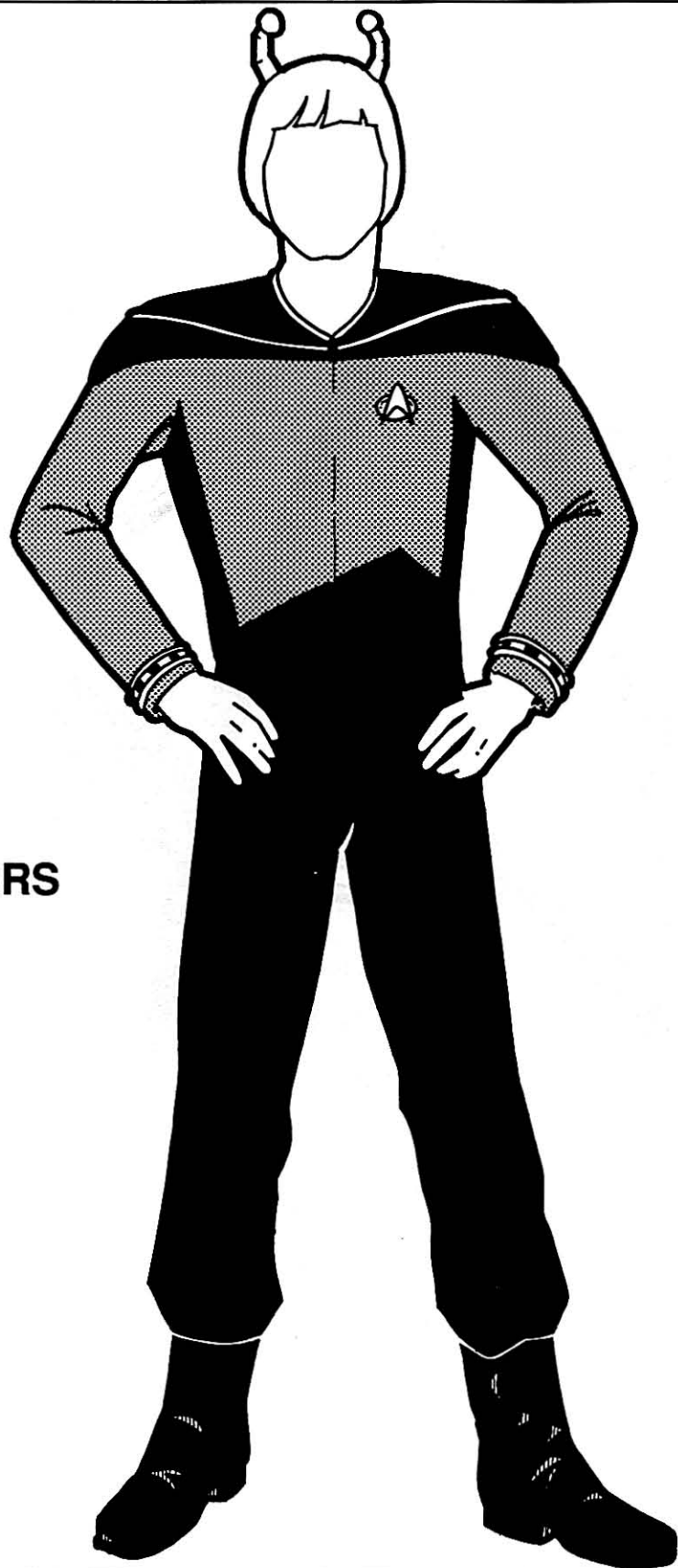

**WARRANT OFFICERS
UNIFORM**

PERSONAL COMMUNICATOR

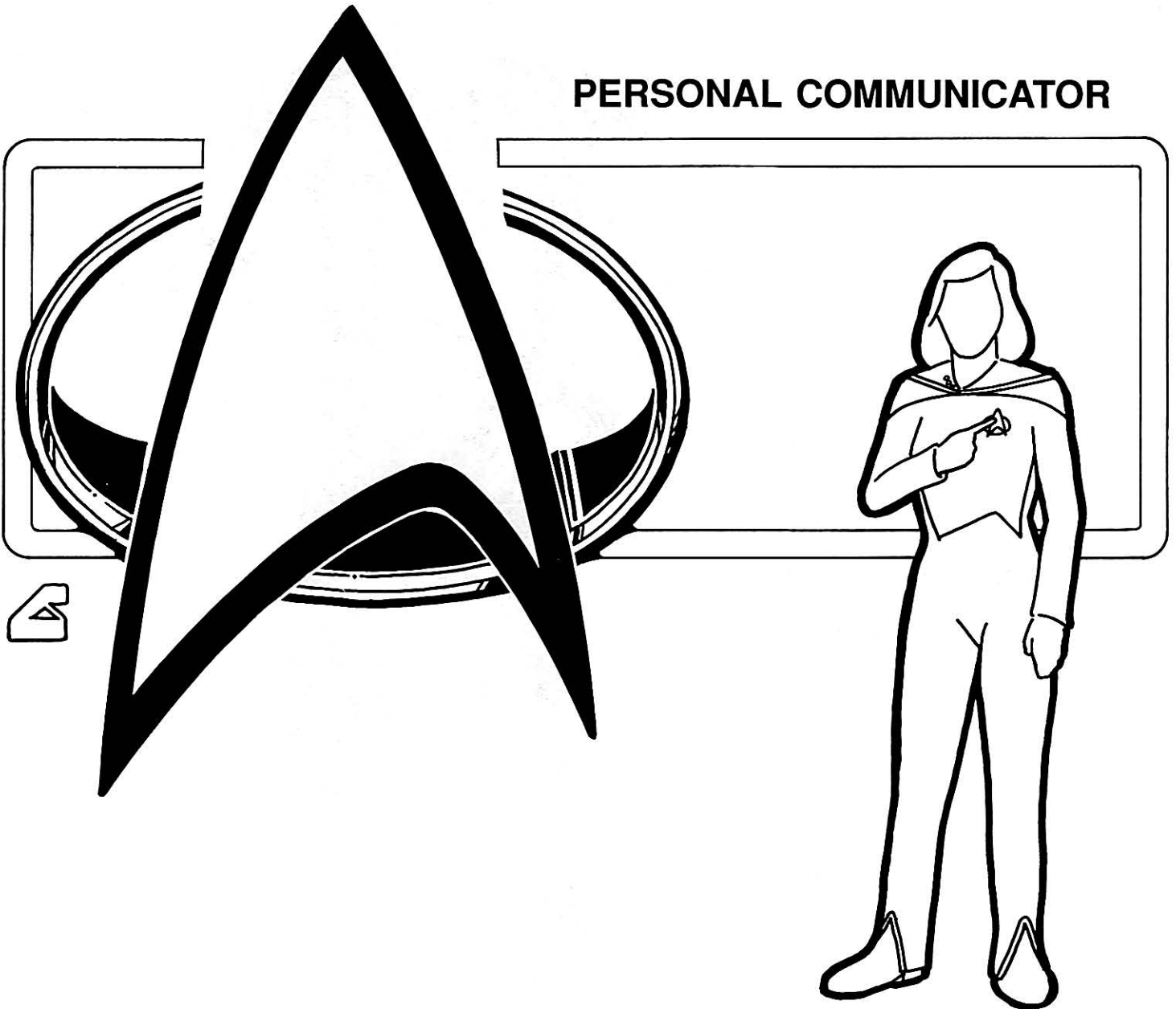

STARFLEET SECURITY CODES

Starfleet maintains a variety of security codes for use during both peacetime and wartime. These codes are arranged by priority from 1 to 50. The function of these individual codes are summarized below.

STARFLEET SECURITY CODES (SSC) 1-29

SSC 1-10 codes are for normal peacetime transmissions of varying priorities, with routine transmissions between civilian and commercial planetary centers receiving a priority dispatch of 1 through 5, and levels 6 through 10 used for Starfleet communications.

SSC 11-20 are used in conditions of hostilities between the Alliance and a foreign power. These priorities are used to transmit orders regarding the disposition of vessels and ground troops, the relocation of civilian personnel, the assigning of Starfleet resources to different commands, operations orders for these commands, and specific operations orders.

SSC 21-29 are for use by the Federation Diplomatic Corps.

STARFLEET SECURITY CODES (SSC) 30-50

These codes specify conditions of emergency, with variable priority levels given to specific problems or crisis conditions during peacetime operations.

SSC 30

Transmission of a communication at SSC 30 code indicates an emergency condition involving a planetary disaster or other unspecified emergency. Use of this code level means that the sending station is not able to adequately respond to the emergency and requires immediate help at the scene.

SSC 31

The SSC 31 code level is used for a medical emergency.

SSC 32

The SSC 32 code indicates a planetary crisis of natural origin.

SSC 33

The SSC 33 code level is used for a bio-medical crisis requiring immediate evacuation of personnel.

SSC 34

An SSC 34 communication indicates a bio-medical crisis requiring immediate quarantine.

SSC 35

An SSC 35 code level signals an ecological disaster or similar planetary crisis.

SSC 36-38

SSC 36-38 code levels are used for crises of unknown origin that require the immediate evacuation of a large segment of a planet's populace.

SSC 39

Use of the SSC 39 code level indicates an attack by unknown agents on Federation personnel or civilian installations or residences.

SSC 40

Transmissions coded at SSC 40 level are directed to a specific Starship or Star Base Chief Science Officer, for disclosure to ship or base command staff only.

SSC 41

SSC 41 is similar to an SSC 40 transmission except that it is only for disclosure to the most senior officer present.

SSC 42

SSC Code 42 transmissions are directed to a specific Starship or Star Base Chief Medical Officer, for disclosure to ship or base command staff only.

SSC 43

SSC 43 is similar to an SSC 42 transmission, except that it is for disclosure to the most senior officer present.

SSC 44

SSC Code 44 transmissions are directed to specific Starship or Star Base Security Chiefs, for disclosure to ship or base command staff only.

SSC 45

SSC 45 messages are similar to those using SSC 44, except that they may be disclosed only to the most senior officer present.

SSC 46

The SSC 46 code level is for direct messages to Starfleet Flag Officers of the rank of Captain and higher.

SSC 47

The SSC 47 Code level is used under circumstances similar to SSC 46, except that no acknowledgement or log entry of the transmission is recorded.

SSC 48

Transmissions at the SSC 48 level are solely for the Commander of Starfleet, President of the United Federation of Planets, or the Commander of the Klingon Defense Force.

SSC 49

The SSC Code 49 transmissions are for members of the Federation High Council or Alliance High Council, or their representatives.

SSC 50

Transmissions coded at the SSC 50 level are for the Alliance President or his designated representatives. No direct acknowledgement or record of these transmissions can be made without the President's prior authorization.

STARFLEET DECORATIONS

Starfleet issues decorations for actions of service and sacrifice beyond the normal duty requirements. They may be awarded either individually or as part of a group distribution to a particular ship or unit. The shape and composition of decorations vary from planet to planet and situation to situation. Such devices are worn only on dress occasions. On other occasions, Terran ground forces wear rectangular ribbon tabs on their forearms, and Starfleet personnel wear triangular tabs on the left breast to denote decorations.

Following are brief descriptions of the most common decorations used within Starfleet.

ANASTAS MEDAL OF ACHIEVEMENT

Origin: Stardate 2/5001, Starfleet Command
Number Awarded: 60

Description:

The Anastas Medal of Achievement, named for the first female starship captain, is awarded to a female officer of executive command rank or higher who has demonstrated superior skill and expertise while facing extreme hazard.

Commander Ellen Childs, Assistant Executive Officer, *USS Berlin*, is the most recent recipient. She received the award on Stardate 3/2007.08 for her expertise and control of a hazardous ship-vs-ship situation against the Ferengi in the absence of her superiors.

The Anastas Medal is a platinum disk showing principal representatives of the Federation with hands joined. Written under them in gold is the inscription, "Achieve Together." The Anastas Medal of Achievement hangs from an aquamarine ribbon.

ANDORIAN BATTLE STAR

Origin: Stardate 1/9501, Andor Planetary Government
Number Awarded: 2,467 (Twelve posthumously)

Description:

The Andorian Battle Star is awarded to commanders of Starfleet vessels, any class or category, who have demonstrated superior tactical abilities in a combat situation, either personal or command-oriented.

Lieutenant Commander Sheva Hev'lek, Chief of Security, *USS Sheffield*, is the latest recipient. She received the Battle Star on Stardate 3/0912.27, for protecting the lives of Federation civilians against a superior force of Ferengi merchant enforcers on Borgia V.

The Andorian Battle Star is a four-pointed Titanium star with a center sapphire, hung from a blue and white ribbon.

CITATION OF CONSPICUOUS GALLANTRY

Origin: Stardate 1/4010 Starfleet Command
Number Awarded: 12,304 (112 posthumously)

Description:

This citation commends acts of heroism in defense of Federation citizens and their property in which the recipient disregarded clear risk to personal safety.

The citation of Conspicuous Gallantry is a small emerald triangle with three diamonds in the middle and a silver semi-circular bar above, which is inscribed "For Gallantry."

Lieutenant David Manchester, *USS Wellington*, is the latest recipient. He received the Citation on Stardate 3/0405.17 for offering himself as hostage to a group of renegade Klingons in exchange for the release of 25 Federation civilians on Valoria. Manchester endured severe torture and mistreatment before he could be rescued.

COCHRANE AWARD

Origin: Stardate 2/0001, The Alpha Centauri Academy of Science and Technology
Number Awarded: 14

Description:

The Cochrane Award is presented to a scientist who, in the spirit of Zephram Cochrane, has contributed to the Federation through outstanding performance in physical sciences or advanced engineering application.

Dr. Caroline Ravenwood is the latest recipient. She received the Cochrane Award on Stardate 2/29.16 for her breakthroughs in psychotherapeutic engineering, which made possible the invention of the Holodeck. The Holodeck is used throughout the Federation as a therapeutic tool in the treatment of mental disorders, as well as for instructional and entertainment purposes.

The Cochrane Award is a silver filigree with precious stones denoting the atomic structure of a dilithium nucleus. In addition to the award's formal device, a parchment inscribed with gold ink describes the individual's scientific accomplishment.

DENEBIAN SWAN OF MERIT

Origin: Stardate 2/1201, Deneb IV Planetary Government
Number Awarded: 46

Description:

The Denebian Swan of Merit is awarded to individuals who have displayed valor in the service of the planet Deneb or its citizens in the course of Federation duties.

Ensign Nathaniel Zar III, *USS Thor*, Starfleet Merchant Marine, is the latest recipient. He was awarded the Denebian Swan of Merit on Stardate 2/8712.17. After his superiors were killed in an unprovoked Ferengi attack, Ensign Zar singlehandedly prevented the Ferengi boarding party from seizing Denebian mercantile goods of considerable commercial value.

GRANKITE ORDER OF HONOR

Origin: Stardate 1/9802, proposed by the Confederation of Tellar; issued by special order of the Commandant of Starfleet Academy, Starfleet Command
Number Awarded: 23

Description:

This special decoration is awarded to cadets who, during their tour of study at Starfleet Academy, demonstrate selfless heroism in support of the Federation and Starfleet Command. The decoration is named in honor of Grankess 'Lorr, a Tellarite cadet who was the first recipient.

Cadet Kimberly Calabrese is the latest recipient. She was awarded the Grankite Order of Honor on 3/1006.5 for her rescue of four comrades in a warp micro-shuttle training accident near Memory Alpha. Calabrese sustained serious injuries as a result.

The Grankite Order of Honor is a small red, blue, and gold triangle surrounded by Tellarite white laurel leaves.

KARAGITE ORDER OF HEROISM

Origin: Stardate 1/9603, The United Federation of Planets Executive Council

Number Awarded: 1,107

Description:

This decoration is awarded to individuals who have shown conspicuous heroism in defense of Federation worlds and their populations in times of conflict. It is named in honor of the successful Starfleet Marine defense of the planet Karag against Klingon invaders during the Four Years War.

Lieutenant Asham Razi, *USS Hood*, is the latest recipient. He was awarded the Karagite Order on Stardate 3/0003.17 for his capture of a previously unknown pirate base on the planet Gibraltar.

The Karagite Order of Honor is a stylized humanoid female with outstretched arms grasping an upraised sword, attached to scarlet and white horizontal stripes.

STARFLEET MEDAL OF HONOR

Origin: Stardate 0/9105, United Earth Alliance Parliament

Number Awarded: 512 (29 posthumously)

Description:

The highest decoration awarded by Starfleet Command and the United Federation of Planets, the Starfleet Medal of Honor is given to individuals who show self-sacrifice, heroism, and courage despite extreme peril in the service of the United Federation of Planets. Because recipients are considered to be the embodiment of the highest ideals of the Federation, their descendants may automatically enter the Starfleet Academy.

Captain Delrin Toval, *USS Hindenberg*, is the latest recipient. He was awarded the Starfleet Medal of Honor on Stardate 2/9905.12 for his heroism in evacuating his crew without the loss of a single life after an unprovoked attack by IKS warships. The Starfleet Medal of Honor is a stylized UFP symbol superimposed on a solid gold disk set against a silver, five-pointed star. The decoration is attached to a red, white, and blue vertical striped ribbon.

STARFLEET MEDAL OF VALOR

Origin: Stardate 1/9604, Starfleet Command, United Federation of Planets

Number Awarded: 234 (49 posthumously)

Description:

The Starfleet Medal of Valor is awarded in peace or wartime for actions beyond the call of duty.

Lieutenant Commander Marsha Mintaine, *USS Valkyrie*, is the latest recipient. She was awarded the Starfleet Medal of Valor on Stardate 2/9704 for her appeasement of hill tribes on Loris VIII at the cost of considerable physical and emotional injury. Her action prevented the deaths of numerous fellow officers. The decoration is a stylized set of stars, each representing one of the founders of the Federation, which are attached to a ribbon of diagonal blue and silver stripes.

PRANTARES RIBBON

Origin: Stardate 1/9704, The Prantares Council of Elders

Number Awarded: 244 (3 posthumously)

Description:

The Prantares Ribbon is awarded to military personnel or civilians who have saved the life of a Federation civilian through peaceful means.

Lieutenant Commander Tholev Shavahar, *USS Locknar II*, is the latest recipient. He was awarded the Prantares Ribbon on Stardate 3/0207.12 for his rescue of 17 mining engineers on Bactria III.

The decoration is a stylized Prantarian lamb surrounded by a green wreath, with the inscription "High Protector" below.

SHUVALIS DIAMOND OF RECOGNITION

Origin: Stardate 2/1705, Vulcan Planetary Government

Number Awarded: 67

Description:

The Shuvalis Diamond of Recognition recognizes individuals who have advanced peaceful relations with newly discovered life forms.

Captain Amanda Kincaid, *USS Fearless*, is the latest recipient. She was awarded the Shuvalis Diamond of Recognition on Stardate 2/8202 for her efforts in favor of the planet Haven joining the Federation. She worked tirelessly for the cause despite the hostility that many planetary officials felt toward the idea.

The decoration is a three-dimensional diamond surrounded by a hollow ruby double crescent.

FEDERATION PEACE MEDAL

Origin: Stardate 2/1005. Originally issued by the Tellarite Planetary Government, adopted as a United Federation of Planets award in 2/2001. The design was modified in 2/8801.

Number Awarded: 149

Description:

The Federation Peace Medal commends an individual who has set a personal example of fostering peace, mutual respect, and cooperation among divergent races.

Ambassador Elias Rinn is the latest recipient. He was awarded the Federation Peace Medal on Stardate 2/9905.17, for bringing the planet Halka into the Federation, despite several decades of refusals by the Halkan High Council.

This medal is an elongated star set against a gold "Enterprise" arrowhead held in upraised hands.

ACADEMY SLANG

Tradition and the incorporation of divergent races into the service of the Federation have produced an entire sub-language used by junior officers in Starfleet Command. The most commonly used terms are defined below for the information of new cadets.

ANDOR TOAST (NOUN)

Andor toast refers to any foul-tasting or otherwise inedible food. The term is commonly used to refer to standard survival-ration concentrates.

AXANAR (ADJ.)

Describes a singular waste of time and effort. The term is of Klingon origin.

BABEL (NOUN)

A group of merry-makers.

CC (NOUN)

An abbreviation for "computerized cranium," a derogatory phrase referring to an annoyingly intelligent person.

CRASH AND BURN (EXPR.)

To fail an examination.

DC (NOUN)

Short for Damage Control. To be engaged in DC operations refers to a cadet's attempts to cover up a blatant error before an upperclassman or superior detects it.

DIODE FAILURE (EXPR.)

Mental exhaustion from work or study.

DUNSEL (NOUN)

A piece of equipment for which there is no logical purpose.

FIRE PHOTONS (EXPR.)

To encounter digestive trouble while engaging in zero-gravity exercises.

KIRK (VERB)

To solve a problem by unconventional means, a talent for which Star Fleet Admiral James Tiberius Kirk was famous.

KOBO (NOUN)

An individual who is undergoing an examination or test without being aware of the nature of the problem. The term is derived from the "Kobayashi Maru."

MISTHEAD (NOUN)

A person with no real conception of reality; an Academy midshipman.

MURDER MILE (NOUN)

The Star Fleet Academy obstacle course.

ORION (NOUN)

An underhanded and deceitful action; to carry out such an action for personal gain (verb).

PLEBE (NOUN)

A first-year cadet; an individual with no privileges or status; a non-sentient life form.

POWER DOWN (VERB)

To relax off duty, usually in the company of comrades.

RED-SHIRTED (ADJ.)

A cadet or junior officer who has been caught in a grievous error and is now being called to account for his actions. The term comes from the early red-uniformed Security Branch of Starfleet, an arm noted for its high casualty rate. To be red-shirted is to be involuntarily transferred to a branch of service with a high mortality rate.

RIDGEHEAD (ADJ.)

A derogatory term that refers to Klingons, in general, and Imperial Klingons, in particular.

RIDGE OUT (VERB)

To be consumed by a violent rage and to lose all emotional control. The term refers to the cranial ridge of Imperial Klingons and to the traditional Klingon tendency toward violent temperament.

SENSORS LOCKED (EXPR.)

A term used by junior cadets to describe that they have noted a member of the opposite sex coming suddenly into view.

SNOWHEAD (NOUN)

An Andorian.

STRAWBRICKER (NOUN)

An Academy instructor who denies students proper access to research materials required for an assignment.

TANTY (ADJ.)

Emotionally disturbed or insane. The word is a corruption of the name Tantalus.

TOOL UP (VERB)

To study or prepare intensively for an exercise.

TRIBBLE (NOUN)

Anyone with a weight problem.

THROEPHOBE (NOUN)

An alien cadet or officer who has extreme difficulty mastering Human mannerisms and speech.

VULCANIZED (ADJ.)

Something that has been made more complex or intricate than necessary.

WARP OFF (VERB)

To leave as quickly as possible.

ZIFFLE (NOUN)

A Tellarite.

EVOLUTION OF THE TRANSWARP FLEET 29

FLEET OF TOMORROW

The uninhibited growth of the United Federation of the Planets over the last half-century has changed almost every aspect of Starfleet doctrine. The increasingly vast distances between member worlds, the introduction of new races into Starfleet, and the absorption of the former Klingon Imperial Navy are among the major factors that created a need for new procedures to carry out new kinds of missions.

Since the first *USS Enterprise* cruiser left Space Dock on its maiden voyage 1/8802 bigger and better starships have been constructed, weapon systems have grown progressively more potent, and propulsion and computer systems have become smaller and more efficient. Today, we can look back on numerous successful starship designs as well as equally notable failures. Some designs, such as the *Loknar*, *Thufir*, and *Andor* Classes, all Andorian specifications, remain in mothballs at Memory Alpha. The fact that plans exist for the emergency refitting and upgrading of these designs is a tribute to their durability and longevity. The *Excelsior* Class battleship, once known affectionately as the "Great Experiment," also remains on operational status.

Two technological innovations have done the most to change the fleet: the transwarp drive propulsion system and the intelligent computer. Transwarp engines have dramatically reduced the normal wear and tear associated with conventional warp drive systems, increasing a vessel's operational life and periods between refits. Recent scientific breakthroughs have also produced a new generation of computers capable of independent thought. Because these new computers handle many tasks previously performed by crew members, starship crews are now staffed with fewer support personnel and more advanced specialists than would previously have been possible. Indeed, new starship designs will increasingly resemble mobile laboratories and science institutes instead of space ferries and weapons platforms.

The modern fleet has undergone significant social changes as well, for Starfleet now places greater emphasis on maintaining normal lifestyles aboard fleet vessels. To minimize the hardships of long separations, Starfleet vessels now carry the families of crew members as well as civilian personnel working as part of the crew.

In terms of deployment, the number of vessels on station today is roughly the same as at the end of the last century. Considering how much the Federation has expanded, however, the phrase "the only ship in the quadrant" is often as true as it was some 200-odd years ago.

With continuing threats by foreign powers such as the Ferengi, today's Starfleet is hard-pressed to cover all its responsibilities. This problem has been partially resolved through the construction of more than 100 support installations and star bases to discourage foreign aggression and to act as forward bastions or choke points when hostilities do break out.

Though Starfleet is still a military arm of an interstellar government, it serves as much as a tool of the explorer, the diplomat, the scientist, and the social reformer.

FLEET SHIP DESIGNS

The following specifications and technical data incorporate the most recent declassified information on Federation starships developed over the past 60 years, as well as older vessel classes still operating within various fleet commands. The ships are presented chronologically, according to the date the class was first introduced. Ship classes are listed in the order introduced.

THE ENTERPRISE LEGACY

After the loss of the *USS Enterprise* NCC 1701-A, Starfleet Command decided to continue the tradition of the name by baptizing an *Excelsior* Class Battleship as a new *USS Enterprise*. Instead of assigning it a different hull number and adding a "II" to its name, Starfleet decided to retain the Naval Construction Contract Number 1701, and place a letter after it.

Some were opposed, arguing that the *Enterprise* was a heavy cruiser and not a battleship. If Starfleet wanted to retain the *Enterprise* name, it should go to one of the new *Constellation* Class cruisers, with their distinctive quadruple nacelle design.

In the end, the *Excelsior* Class kept the *Enterprise* name because this class was intended to be the new workhorse of Starfleet, much like the *Constitutions* and *Enterprises* of a few decades earlier. Starfleet officials believed that the *Enterprise* name should be given to a ship class that would have high visibility.

Ironically, the *Constellation* cruiser became a famous class in its own right, for one of its number served as Captain Jean-Luc Picard's ship in the engagement with the Ferengi that led to his famous "Picard Maneuver."

The battleship *USS Enterprise*, NCC 1701-B had its own distinguished career. Loosely assigned to Star Base 12, the ship took part in many engagements in the Neutral Zone and the Triangle. It also served on 4 five-year galaxy exploration tours, recording a number of first contacts. The career of the *Enterprise* also boasted the least crew losses by death for six years straight. A far cry from her predecessor!

The *Enterprise* often served as a transport for dignitaries. Its passengers included, at one time or another, the Klingon Emperor and his consort, the Romulan Praetor, six of the most powerful Orion families, the whole Vulcan political hierarchy, 50 Star Fleet Admirals, and the entire Federation Council. Fortunately, they were not all aboard simultaneously!

The *Enterprise's* career ended in a fashion befitting its name and class. On Stardate 2/9208.12, the *USS Enterprise* engaged an IKS L-24 battleship and a Romulan *Nova* Class battleship, which were working together in the Triangle, five parsecs from the Imperial Klingon States. Though the Romulan and Klingon vessels were defeated, it was a pyrrhic victory, for the *USS Enterprise* also fell. Fearful of losing any more of its already scarce ships-of-the-line, the IKS pulled back its fleet and cut back its Neutral Zone raids almost to nothing.

EXCELSIOR CLASS XIII TRANSWARP BATTLESHIP

Construction Data:

Model Number—	MK II
Date Entering Service—	2/2303
Number Constructed—	38

Hull Data:

Superstructure Points—	37
Damage Chart—	C
Size	
Length—	467 m
Width—	186 m
Height—	78 m
Weight—	239,645 mt

Cargo

Cargo Units—	100 SCU
Cargo Capacity—	5,000 mt
Landing Capability—	None

Equipment Data:

Control Computer Type—	M-8
Transporters—	
standard 6-person	6
emergency 22-person	6
cargo	3

Other Data:

Crew	802
Passengers	40
Shuttlecraft	20

Engines And Power Data:

Total Power Units Available—	128
Movement Point Ratio—	6/1
Warp Engine Type—	FTWAI
Number—	2
Power Units Available—	48
Stress Charts—	D/F
Maximum Safe Cruising Speed—	Warp 12
Emergency Speed—	Warp 14
Impulse Engine Type—	FIG-2
Power Units Available—	32

Weapons and Firing Data:

Beam Weapon Type—	FH-11
Number—	8 in 5 banks
Firing Arcs—	1 f/p, 2f, 1 f/s, 2 p/a, 2 s/a
Firing Chart—	Y
Maximum Power—	10
Damage Modifiers—	
+3	(1 – 10)
+2	(11 – 17)
+1	(18 – 24)

Missile Weapon Type—

Number—	FP-4
Number—	6
Firing Arcs—	1f, 2f/p, 2 f/s, 1a
Firing Chart—	S
Power To Arm—	1
Damage—	20

Shields Data:

Deflector Shield Type—	FSS
Shield Point Ratio—	1/4
Maximum Shield Power—	20

Combat Efficiency:

D—	174.91
WDF—	160.60

Disposition:

The following list of *Excelsior* Class cruisers shows their hull numbers, name, model designation, date entering service, and current disposition. The disposition is represented by the letter codes given below and is followed by the date of occurrence if known.

B: Built
 D: Destroyed in Action
 L: Lost, Whereabouts Unknown
 M: Mothballed
 Sc : Scrapped
 T: Decommissioned as Training Vessel

NX 2000 <i>Excelsior</i>	B 2/2210 T 2/9005
NX 2001 <i>Proxima</i>	B 2/2312 D 2/7001
NX 2002 <i>Columbia II</i>	B 2/2302 M 2/9909
NX 2003 <i>Galacta II</i>	B 2/2406 L 2/5505
NCC 2004 <i>Excalibur</i>	B 2/2506 M 2/9907
NCC 2005 <i>Potemkin</i>	B 2/2612 M 3/0001
NCC 2006 <i>Hancock</i>	B 2/2706 D 2/6004
NCC 2007 <i>Kitty Hawk II</i>	B 2/2712 M 3/0002
NCC 2008 <i>Chikuma</i>	B 2/2806 L 2/9008
NCC 2009 <i>Kongo II</i>	B 2/2812
NCC 2010 <i>Ajax II</i>	B 2/2904
NCC 2011 <i>Achilles II</i>	B 2/2912
NCC 2012 <i>Arizona II</i>	B 2/3006 D 2/3107
NCC 2013 <i>Royal Oak II</i>	B 2/3012 T 2/7705
NCC 2014 <i>Agincourt II</i>	B 2/3108 L 2/4804
NCC 2015 <i>Yamashiro II</i>	B 2/3112
NCC 2016 <i>Exeter II</i>	B 2/3302
NCC 2017 <i>Hood II</i>	B 2/3512
NCC 2018 <i>Valiant II</i>	B 2/3809 D 2/8703
NCC 2019 <i>Fuso II</i>	B 2/3310 D 2/5707
NCC 2020 <i>Intrepid II</i>	B 2/4909
NCC 2021 <i>Farragut II</i>	B 2/4402
NCC 2022 <i>Ryujo II</i>	B 2/3412 D 2/6007
NCC 2023 <i>Challenger II</i>	B 2/3612
NCC 2024 <i>Sussex II</i>	B 2/3712 D 2/8703
NCC 1701B <i>Enterprise</i>	B 2/3910 D 2/8202
NCC 2025 <i>Constitution II</i>	B 2/4011
NCC 2026 <i>Lexington II</i>	B 2/4112
NCC 2027 <i>Bearn II</i>	B 2/4209 L 2/9604
NCC 2028 <i>Aquila II</i>	B 2/4312
NCC 2029 <i>De Mayo</i>	B 2/4510 D 2/7609
NCC 2030 <i>Brisbane II</i>	B 2/4611
NCC 2031 <i>Eagle II</i>	B 2/4712
NCC 2032 <i>Thunderer II</i>	B 2/4811 L 2/8812
NCC 2033 <i>Yorktown II</i>	B 2/5110
NCC 2034 <i>Ticonderoga II</i>	B 2/5207
NCC 2035 <i>Alamo</i>	B 2/5312
NCC 2036 <i>Fearless II</i>	B 2/5409

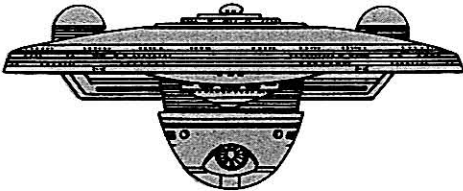
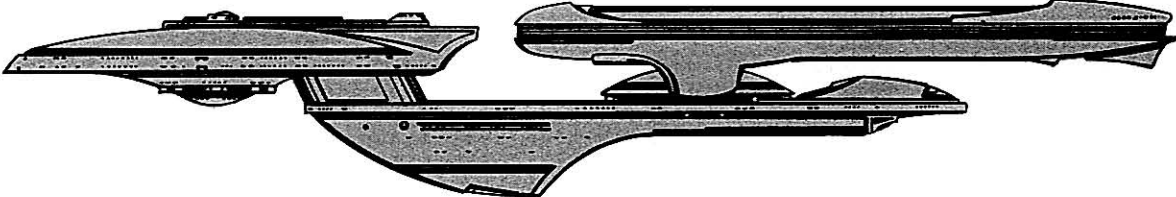
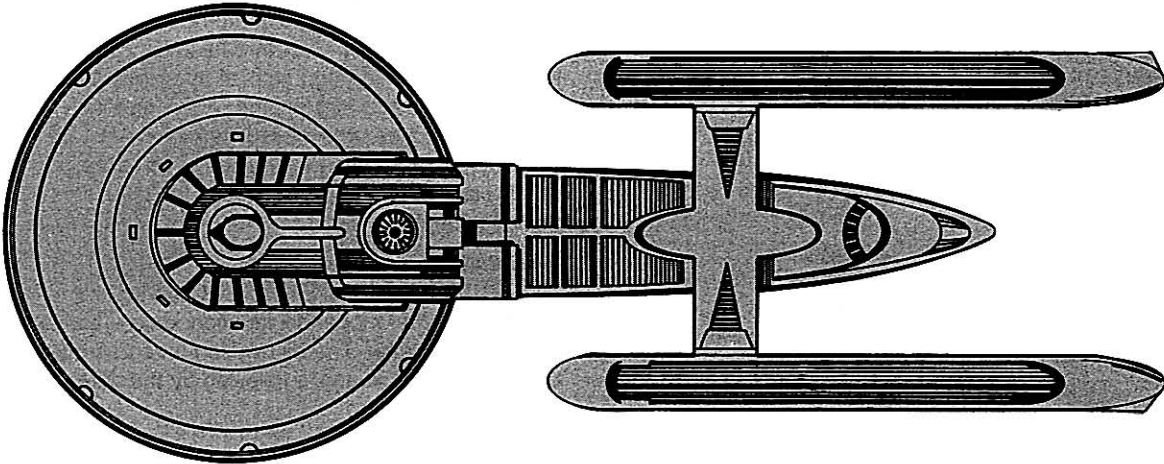

ENTERPRISE CLASS XII CRUISER

Construction Data:

Model Number—	MK IV
Date Entering Service—	2/2802
Number Constructed—	50

Hull Data:

Superstructure Points—	32
Damage Chart—	C
Size	
Length—	322 m
Width—	131 m
Height—	78 m
Weight—	197,543 mt

Cargo

Cargo Units—	450 SCU
Cargo Capacity—	22,500 mt
Landing Capability—	None

Equipment Data:

Control Computer Type—	M-7A
Transporters—	
standard 6-person	4
combat 12-person	4
cargo, large	2
cargo, small	2

Other Data:

Crew—	422
Passengers—	50
Shuttlecraft—	10

Engines and Power Data:

Total Power Units Available—	66
Movement Point Ratio—	4/1
Warp Engine Type—	FTWC-2
Number—	2
Power Units Available—	25
Stress Charts—	D/E
Maximum Safe Cruising Speed—	Warp 12
Emergency Speed—	Warp 14
Impulse Engine Type—	FIF-2
Power Units Available—	16

Weapons and Firing Data:

Beam Weapon Type—	FH-11
Number—	8 in four banks of 2
Firing Arcs—	2 f/p, 2 f, 2 f/s, 2a
Firing Chart—	Y
Maximum Power—	10
Damage Modifiers—	
+3	(1–10)
+2	(11–17)
+1	(18–24)
Missile Weapon Type—	FP-4
Number—	4
Firing Arcs—	2f, 2a
Firing Chart—	S
Power to Arm—	i
Damage—	

Shields Data:

Deflector Shield Type—	FSP
Shield Point Ratio—	1/4
Maximum Shield Power—	16

Combat Efficiency:

D—	195.76
WDF—	135.60

Notes:

When the original *Excelsior* design was refitted with transwarp technology, planners quickly recognized the need for a support vessel capable of exploration as well as combat. Federation naval architects inevitably turned to the proven *Enterprise* Class heavy cruisers. On Stardate 2/2212.21, the *USS Valiant*, NCC 1718, was the first ship of its size to be refitted with an experimental transwarp engine. After upgraded computer support systems overcame initial design problems, Starfleet began a wholesale refitting of Mark III vessels. The excellent record of this sturdy class over so long a period of time warrants its inclusion in this document.

Disposition:

The following list of *Enterprise* Class cruisers shows their hull numbers, name, model designation, date entering service, and current disposition. The disposition is represented by the letter codes given below and is followed by the date of occurrence, if known.

B: Built
D: Destroyed in Action
L: Lost, Cause Unknown
M: Mothballed
Re: Refit
Sc: Scrapped
T: Decommissioned as Training Vessel

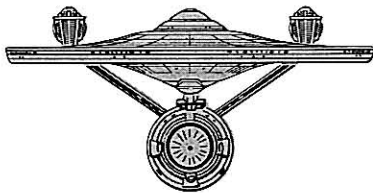
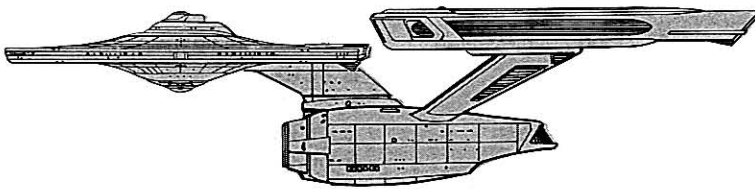
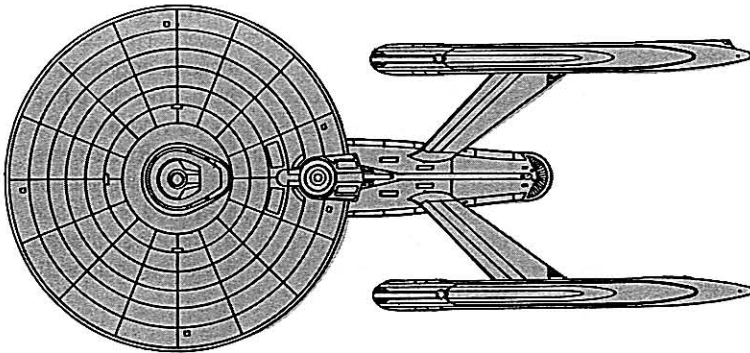

NCC 1701A <i>Enterprise</i>	B 2/2212
NCC 1703 <i>Hood</i>	D 2/3503
NCC 1704 <i>Bismarck</i>	Re 2/2802 Sc 2/3512
NCC 1706 <i>Constellation</i>	Re 2/2512 Sc 2/4003
NCC 1707 <i>Intrepid</i>	Re 2/2812 Sc 2/4812
NCC 1708 <i>Farragut</i>	Re 2/2511 Re 2/3308 L 2/4311
NCC 1709 <i>Lexington</i>	Re 2/2601 Re 2/3309 Sc 2/3812
NCC 1710 <i>Kongo</i>	D 2/2607
NCC 1712 <i>Exeter</i>	Re 2/2602 Re 2/3311 Sc 2/5001
NCC 1715 <i>Challenger</i>	Re 2/2810 Sc 2/3507
NCC 1716 <i>Zuiho</i>	D 2/2812
NCC 1717 <i>Yorktown</i>	Re 2/2312 D 2/3808
NCC 1718 <i>Valiant</i>	Re 2/2212 D 2/3806
NCC 1719 <i>Essex</i>	Re 2/2406 T 2/2909 Sc 2/5001
NCC 1720 <i>Saratoga II</i>	Re 2/3606 M 2/5003
NCC 1721 <i>Kearsarge</i>	Re 2/3607 M 2/5101
NCC 1724 <i>El Dorado II</i>	Re 2/3608 L 2/4702
NCC 1726 <i>Graf Zeppelin</i>	Re 2/2401 Re 2/3309 Sc 2/5511
NCC 1730 <i>Soryu</i>	Re 2/2406 Re 2/3311 Sc 2/5510
NCC 1731 <i>Hiryu</i>	Re 2/2407 D 2/2703
NCC 1732 <i>Valley Forge</i>	Re 2/2409 Re 2/3212 Sc 2/5511
NCC 1733 <i>Oriskany</i>	D 2/2510
NCC 1734 <i>Wasp</i>	Re 2/2401 Re 2/3302 Sc 2/5512
NCC 1738 <i>Eagle</i>	Re 2/2411 Re 2/3303 D 2/4707
NCC 1740 <i>King George V</i>	Re 2/3502 M 2/5606
NCC 1741 <i>Prince of Wales</i>	Re 2/3403 M 2/5607
NCC 1742 <i>Santissima Trinidad</i>	Re 2/2604 Re 2/3306 Sc 2/4304
NCC 1743 <i>Franklin</i>	Re 2/3406 Sc 2/5511
NCC 1744 <i>Marseille</i>	D 2/2510
NCC 1745 <i>Bunker Hill</i>	Re 2/3705 M 2/5412
NCC 1751 <i>Forrestal</i>	Re 2/3707 Sc 2/5512
NCC 1752 <i>Minsk</i>	Re 2/2503 Re 2/3802 L 2/5003
NCC 1753 <i>Republic II</i>	Re 2/2511 Re 2/3710 Sc 2/5512
NCC 1760 <i>Victory II</i>	Re 2/2907 Sc 2/5607
NCC 1764 <i>Defiant II</i>	Re 2/2404 Re 2/3710 Sc 2/5710
NCC 1765 <i>Rivoli</i>	Re 2/2407 D 2/2703
NCC 1772 <i>Scharnhorst</i>	Re 2/2408 Re 2/3305 Sc 2/5602
NCC 1773 <i>Gneisnau</i>	Re 2/2410 Re 2/3307 Sc 2/5512
NCC 1774 <i>Emperador</i>	Re 2/3003 T 2/4909 L 2/4912
NCC 1775 <i>Kirishima</i>	Re 2/2808 Re 2/3308 Sc 2/5512
NCC 1776 <i>Bonhomme Richard</i>	Re 2/2412 Sc 2/3212
NCC 1779 <i>Akagi</i>	Re 2/2402 Re 2/3310 Sc 2/5512
NCC 1780 <i>Kaga II</i>	Re 2/2403 Re 2/3311 Sc 2/5512
NCC 1781 <i>Freidland</i>	Re 2/2401 Re 2/3312 Sc 2/5512
NCC 1782 <i>Konigsberg</i>	Re 2/3403 Sc 2/5601
NCC 1783 <i>Ukrainia</i>	Re 2/3405 M 2/5606
NCC 1784 <i>Clemenceau</i>	Re 2/3406 Sc 2/5601
NCC 1785 <i>Marcello</i>	Re 2/3408 M 2/5708

CONSTELLATION CLASS XII HEAVY CRUISER

Construction Data:

Model Number—	1
Date Entering Service—	2/5403
Number Constructed—	126

Hull Data:

Superstructure Points—	32
Damage Chart—	C
Size	
Length—	310 m
Width—	140 m
Height—	94 m
Weight—	208,743 mt

Cargo

Cargo Units—	150 SCU
Cargo Capacity—	12,500 mt
Landing Capability—	None

Equipment Data:

Control Computer Type—	M-6A
Transporters—	
standard 6-person	4
combat 12-person	4
cargo, large	1
cargo, small	2

Other Data:

Crew—	350
Passengers—	20
Shuttlecraft—	8

Engines and Power Data:

Total Power Units Available—	92
Movement Point Ratio—	4/1
Warp Engine Type—	FTWD-2
Number—	2 (4)
Power Units Available—	40
Stress Charts—	E/F
Maximum Safe Cruising Speed—	Warp 12
Emergency Speed—	Warp 14
Impulse Engine Type—	FIF-1
Power Units Available—	12

Weapons and Firing Data:

Beam Weapon Type—	FH-14
Number—	6 in three banks of 2
Firing Arcs—	2s/f, 2p/f, 2a
Firing Chart—	T
Maximum Power—	12
Damage Modifiers—	
+3	(1–5)
+2	(6–12)
+1	(13–18)

Missile Weapon Type—

Number—	4
Firing Arcs—	2 f/p/s, 2 a/p/s
Firing Chart—	S
Power to Arm—	1
Damage—	20

Shields Data:

Deflector Shield Type—	FSQ
Shield Point Ratio—	1/4
Maximum Shield Power—	18

Combat Efficiency:

D—	193.76
WDF—	104.60

Notes:

When the *Enterprise* class was phased out, it created the need for a new heavy cruiser. The new design, the *Constellation* Class heavy cruiser, was a radical departure in warp architecture because of its four-engine-nacelle configuration. This design produces high transwarp speeds, but the vessel's engineering and main power converter areas are vulnerable. The class has distinguished itself, particularly in the action involving the *USS Stargazer* under the command of Captain J.L. Picard. It was in this action that the Captain introduced the now famous Picard Maneuver. Of the 26 *Constellation* Class cruisers constructed, 20 are still in service, 3 have been destroyed, 1 scrapped, and 2 lost (though one of these was subsequently recovered and decommissioned).

Disposition:

The following list of *Constellation* Class heavy cruisers shows their hull numbers, name, model designation, date entering service, and current disposition. The disposition is represented by the letter codes given below and is followed by the date of occurrence, if known.

D: Destroyed in Action
L: Lost, Cause Unknown
R: Recovered
Sc: Scrapped

NCC 2500 <i>Constellation</i>	B 2/6002 Sc 3/0101
NCC 2501 <i>Nova</i>	B 2/6104
NCC 2502 <i>Nebula</i>	B 2/6212 D 2/8807
NCC 2503 <i>Polaris</i>	B 2/6305
NCC 2504 <i>Magellan</i>	B 2/6312
NCC 2505 <i>Andromeda</i>	B 2/6407 D 2/9803
NCC 2506 <i>Libra</i>	B 2/6409
NCC 2507 <i>Sagittarius</i>	B 2/6501 L 2/9004
NCC 2508 <i>Pulsar</i>	B 2/6602
NCC 2509 <i>Callisto</i>	B 2/6607 D 2/8712
NCC 2510 <i>Orion</i>	B 2/6610
NCC 2511 <i>Eridani</i>	B 2/6702
NCC 2512 <i>Taurus</i>	B 2/6705
NCC 2513 <i>Ceres</i>	B 2/6709
NCC 2514 <i>Antares</i>	B 2/6803
NCC 2515 <i>Pisces</i>	B 2/6902
NCC 2516 <i>Lenoid</i>	B 2/6908
NCC 2517 <i>Aquarius</i>	B 2/7002
NCC 2518 <i>Indiri</i>	B 2/7104
NCC 2519 <i>Effros</i>	B 2/7112
NCC 2520 <i>Betelgeuse</i>	B 2/7204
NCC 2521 <i>Diadem</i>	B 2/7301
NCC 2522 <i>Stargazer</i>	B 2/7412 L 2/9303 R 3/0306
NCC 2523 <i>Canopus</i>	B 2/7503
NCC 2524 <i>Sirius Major</i>	B 2/7607
NCC 2525 <i>Minora</i>	B 2/7704

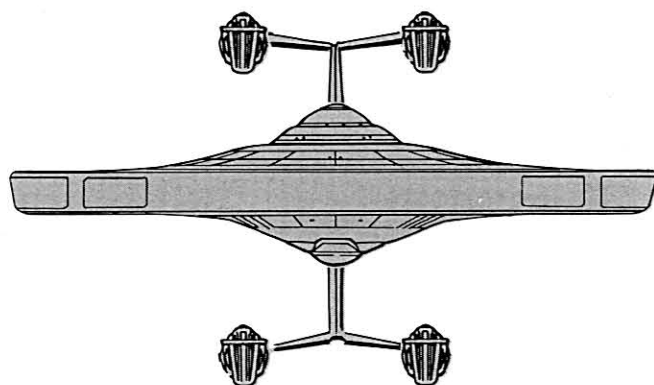
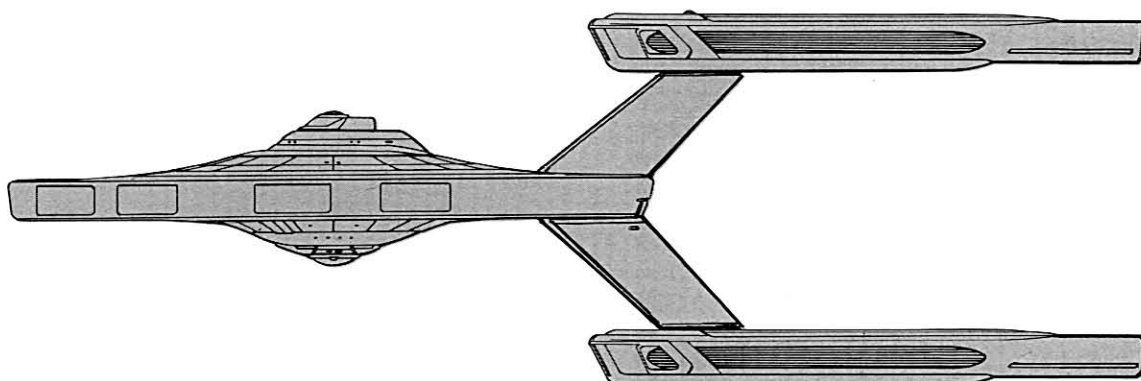
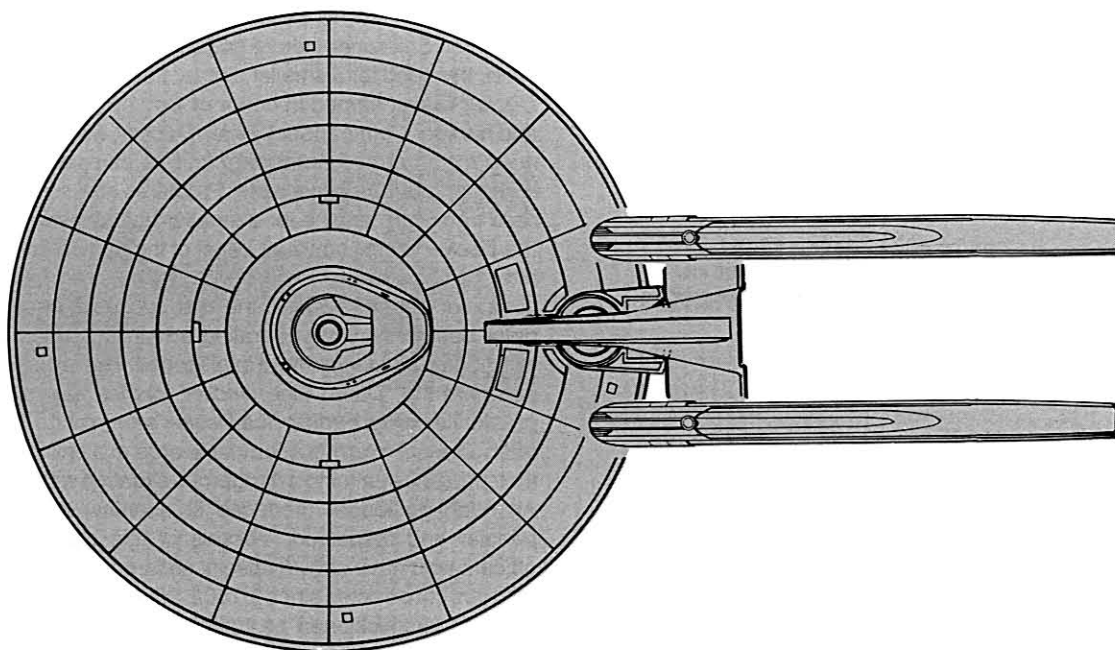

DECKER CLASS X TRANSWARP DESTROYER

Construction Data:

Model Number—	A
Date Entering Service—	2/7502
Number Constructed—	240

Hull Data:

Superstructure Points—	35
Damage Chart—	C
Size	
Length—	288 m
Width—	120 m
Height—	52 m
Weight—	140,603 mt

Cargo

Cargo Units—	200 SCU
Cargo Capacity—	10,000 mt
Landing Capability—	None

Equipment Data:

Control Computer Type—	M-6A
Transporters—	
standard 6-person—	4
combat 12-person—	4
cargo, large—	2
cargo, small—	2

Other Data:

Crew—	200
Passengers—	10
Marines—	100
Shuttlecraft—	4

Engines and Power Data:

Total Power Units Available—	66
Movement Point Ratio—	4/1
Warp Engine Type—	FTWC-2
Number—	2
Power Units Available—	25
Stress Charts—	D/E
Maximum Safe Cruising Speed—	Warp 12
Emergency Speed—	Warp 14
Impulse Engine Type—	FIF-2
Power Units Available—	16

Weapons and Firing Data:

Beam Weapon Type—	FH-11 Phasers
Number—	5
Firing Arcs—	2/f/p, 2/f/s, 1/a
Firing Chart—	Y
Maximum Power—	10
Damage Modifiers—	
+3	(1–10)
+2	(11–17)
+1	(18–24)
Missile Weapon Type—	FP-4 Photon Torpedo
Number—	3
Firing Arcs—	2 f/p/s, 1a
Firing Chart—	S
Power to Arm—	1
Damage—	20

Shields Data:

Deflector Shield Type—	FSM
Shield Point Ratio—	1/1
Maximum Shield Power—	11

Combat Efficiency:

D—	85.18
WDF—	91

Notes:

As the transwarp *Excelsior* Class battleship began to replace the older *Enterprise* heavy cruisers as the workhorses of Star Fleet, the need for a smaller, lighter transwarp vessel arose. The *Decker* Class, named in honor of Commodore Matthew Decker and his son, Commander William Decker, was designed to fill the need for an armed, transwarp ship to carry out various escort, patrol, and deep-space tasks. Problems in redesigning the standard transwarp engine for a smaller hull delayed introduction of the *Decker* Class, however. Most of these problems were solved after the ships were equipped with the Daystrom Duotronics M-9A computer control system, the first successful self-aware computer design system integrating advanced synoptic duotronics with self-regulating artificial intelligence. The large marine contingent that the "Damn Fine *Decker*" carries has given this class greater flexibility. Further, the *Decker's* long range and high speed often allows it to arrive at a volatile area at a critical moment, with their presence calming a dangerous situation without firing a shot. Although no longer produced in quantity, the *Decker* is still popular and respected. Vessels of this class are named for officers who have shown special gallantry or sacrifice. Of the 40 *Deckers* constructed since 2/7502, 20 remain in service, two have been decommissioned as training vessels, and the rest have been lost, scrapped, or destroyed.

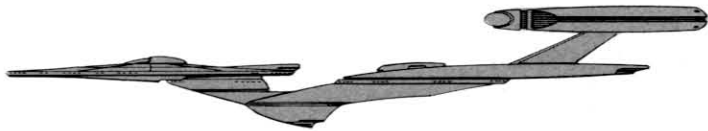
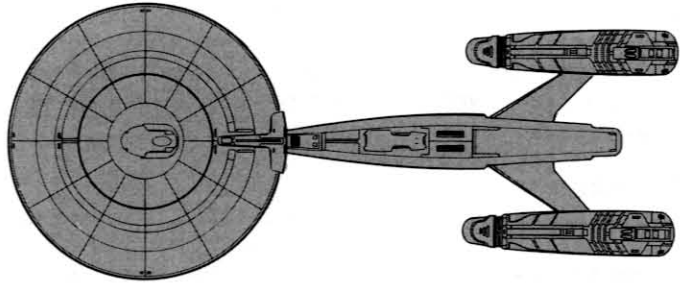

Disposition:

The following list of *Decker* Class cruisers shows their hull numbers, name, model designation, date entering service, and current disposition. The disposition is represented by the letter codes given below and is followed by the date of occurrence, if known.

- B: Built
- D: Destroyed in Action
- L: Lost, Cause Unknown
- Sc: Scrapped
- T: Decommissioned as Training Vessel

NCC 600 <i>Matthew Decker</i>	B 2/7502 T 3/0505
NCC 6001 <i>William Decker</i>	B 2/7502 T 3/0601
NCC 6002 <i>Christopher Pike</i>	B 2/7504 L 2/9902
NCC 6003 <i>Robert April</i>	B 2/7504
NCC 6004 <i>Kelvar Garth</i>	B 2/7505 D 2/7601
NCC 6005 <i>Jonathan T. Esteban</i>	B 2/7602
NCC 6006 <i>Clark Terrell</i>	B 2/7602
NCC 6007 <i>Montgomery Scott</i>	B 2/7704
NCC 6008 <i>Samara Uhura</i>	B 2/7711
NCC 6009 <i>Hikaru Sulu</i>	B 2/7805 D 3/0106
NCC 6010 <i>Pavel Chekov</i>	B 2/7809 L 2/9806
NCC 6011 <i>Koren Anastas</i>	B 2/7906
NCC 6012 <i>Damon West</i>	B 2/7912 D 2/9504
NCC 6013 <i>Anton Thiel</i>	B 2/8003
NCC 6014 <i>Yoshitomo Karasuma</i>	B 2/8008
NCC 6015 <i>Stephen Decatur</i>	B 2/8011 Sc 3/0301
NCC 6016 <i>Nathaniel Zar</i>	B 2/8104
NCC 6017 <i>Meredith Levette</i>	B 2/8104 D 2/9504
NCC 6018 <i>J. L. Lambert</i>	B 2/8202 Sc 3/0311
NCC 6019 <i>Zachary Holmes</i>	B 2/8209
NCC 6020 <i>Kai-Jasik</i>	B 2/8303 D 3/0106
NCC 6021 <i>Peter Marlowe</i>	B 2/8306
NCC 6022 <i>Jason Starion</i>	B 2/8306 Sc 3/0501
NCC 6023 <i>Malcolm Swain</i>	B 2/8306 L 2/91712
NCC 6024 <i>Andre LaSalle</i>	B 2/8601 D 2/9703
NCC 6025 <i>Connor Jacoby</i>	B 2/8601 Sc 3/0207
NCC 6026 <i>Surmass</i>	B 2/8602
NCC 6027 <i>Peter Preston</i>	B 2/8604
NCC 6028 <i>Dietrich Vinsel</i>	B 2/8607 D 2/9807
NCC 6029 <i>Myrr 'lin T'alon</i>	B 2/8609
NCC 6030 <i>Archon Chovich</i>	B 2/8610 L 3/0102
NCC 6031 <i>Stonwin</i>	B 2/8612
NCC 6032 <i>Hieracho Naguro</i>	B 2/8701
NCC 6033 <i>Lawrence Stiles</i>	B 2/8703
NCC 6034 <i>Nherat</i>	B 2/8704 L 2/9903
NCC 6035 <i>Samantha Piper</i>	B 2/8705
NCC 6036 <i>Mandala Flynn</i>	B 2/8706 Sc 3/0506
NCC 6037 <i>Irkin B'tly</i>	B 2/8708 L 3/0201
NCC 6038 <i>Libby Curtis</i>	B 2/8710
NCC 6039 <i>Allison Vinson</i>	B 2/8712

ROYAL SOVEREIGN CLASS XV BATTLECRUISER

Construction Data:

Model Number—	1
Date Entering Service—	2/7701
Number Constructed—	12

Hull Data:

Superstructure Points—	70
Damage Chart—	C
Size	
Length—	625 m
Width—	224 m
Height—	100 m
Weight—	334,825 mt

Cargo

Cargo Units—	600 SCU
Cargo Capacity—	30,000 mt

Equipment Data:

Control Computer Type—	M-9A
Transporters—	
standard 6-person	6
combat 12-person	4
cargo, large	2
cargo, small	4

Other Data:

Crew—	850
Marines—	125
Shuttlecraft—	8

Engines and Power Data:

Total Power Units Available—	136
Movement Point Ratio—	6/1
Warp Engine Type—	FTWA-2
Number—	2
Power Units Available—	52
Stress Charts—	E/G
Maximum Safe Cruising Speed—	Warp 12
Emergency Speed—	Warp 14
Impulse Engine Type—	FIG-2
Power Units Available—	32

Weapons and Firing Data:

Beam Weapon Type—	FH-11
Number—	10 in five banks of 2
Firing Arcs—	4/f, 2/s, 2/p, 2/a
Firing Chart—	W
Maximum Power—	7
Damage Modifiers—	
+3	(1-10)
+2	(11-17)
+1	(18-24)

Missile Weapon Type—

FP-4	
Number—	8
Firing Arcs—	2/f, 2/a, 2/p, 2/s
Firing Chart—	S
Power to Arm—	1
Damage—	20

Shields Data:

Deflector Shield Type—	FSS
Shield Point Ratio—	1/4
Maximum Shield Power—	19

Combat Efficiency:

D—	157.25
WDF—	207

Notes:

The *Royal Sovereign* is equipped with the transwarp engine design so successful in the *Excelsior* battleships and the new quadro-transducer shielding system (QSS). This class has been an unqualified success. Besides functioning as warships, several *Royal Sovereigns* have distinguished themselves as exploration craft, most notably the *Valiant's* initial contact with the humanoid species on Haven. Of the twelve *Royal Sovereigns* built, eight are still in service, two have been lost, and two destroyed. The *Royal Sovereign* Class is produced at the Salazaar Shipyards at the rate of one per year.

Disposition:

The following list of *Royal Sovereign* Class battlecruisers shows their hull numbers, name, model designation, date entering service, and current disposition. The disposition is represented by the letter codes given below and is followed by the date of occurrence, if known.

B: Built

D: Destroyed in Action

L: Lost, whereabouts unknown

NCC 3000 <i>Royal Sovereign</i>	B 2/7701
NCC 3001 <i>Alaska</i>	B 2/7802
NCC 3002 <i>Royal Andor</i>	B 2/8003 L 3/0204
NCC 3003 <i>Kola</i>	B 2/8211
NCC 3004 <i>Royal Proxima</i>	B 2/8402
NCC 3005 <i>Nagato</i>	B 2/8603
NCC 3006 <i>Discovery</i>	B 2/8801
NCC 3007 <i>Saratoga III</i>	B 2/9001
NCC 3008 <i>Royal Centauri</i>	B 2/9203 L 2/9801
NCC 3009 <i>Royal Hibernia</i>	B 2/9404 D 2/9703
NCC 3010 <i>Valiant III</i>	B 2/9605
NCC 3011 <i>Jean Bart</i>	B 2/9812

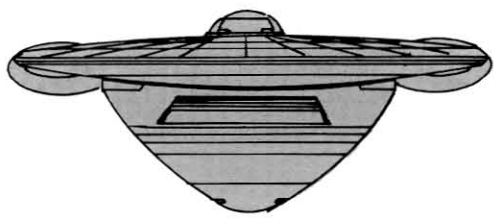
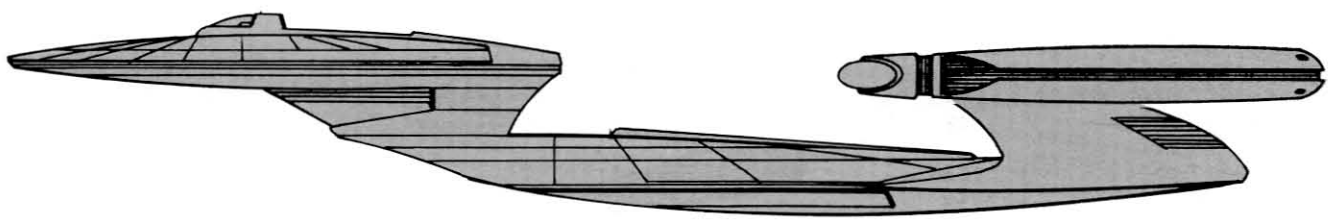
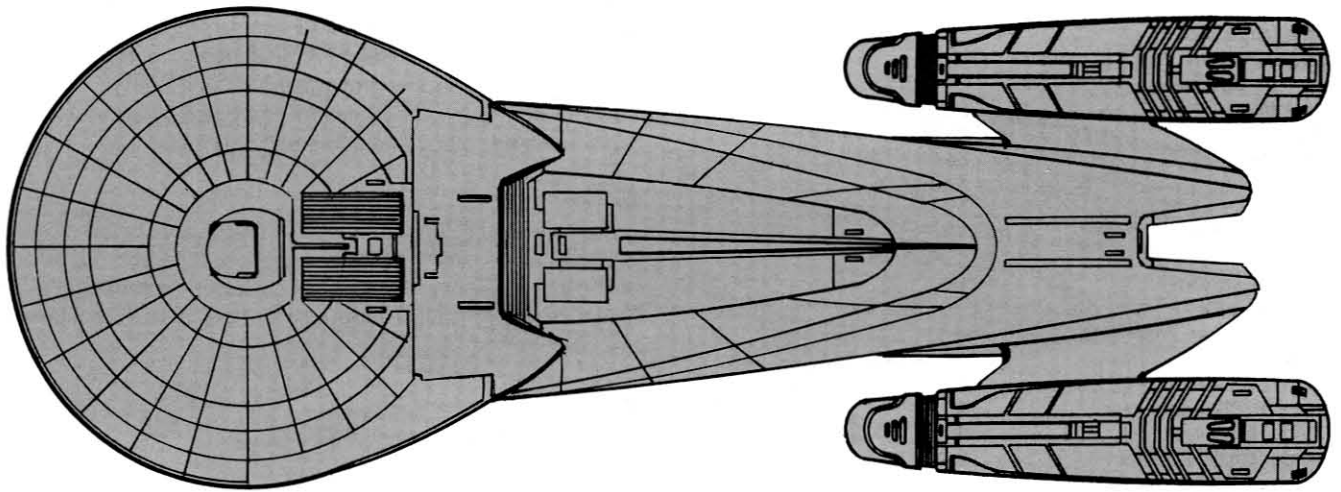

M'BENGA CLASS VII RESCUE/HOSPITAL SHIP

Construction Data:

Model Number—	1
Date Entering Service—	2/8003
Number Constructed—	13

Hull Data:

Superstructure Points—	17
Damage Chart—	
Size	
Length—	220 m
Width—	88 m
Height—	55 m
Weight—	92,000 mt

Cargo

Cargo Units—	900 SCU
Cargo Capacity—	45,000 mt
Landing Capability—	No

Equipment Data:

Control Computer Type—	M-2
Transporters—	
standard 6-person	6
combat 12-person	4
cargo, large	2
cargo, small	2

Other Data:

Crew—	130
Patients—	170
Shuttlecraft—	4

Engines and Power Data:

Total Power Units Available—	40
Movement Point Ratio—	4/1
Warp Engine Type—	FWH-2
Number—	2
Power Units Available—	14
Stress Charts—	Q/R
Maximum Safe Cruising Speed—	Warp 6
Emergency Speed—	Warp 8
Impulse Engine Type—	FIF-1
Power Units Available—	12

Shields Data:

Deflector Shield Type—	FSN
Shield Point Ratio—	1/2
Maximum Shield Power—	16

Combat Efficiency:

D—	75.31
WDF—	0

Notes:

With the expansion of the Federation's borders, Starfleet has recognized the need for a long-range rescue craft that can provide emergency medical support to distant colonies and to vessels in deep space. The *M'Benga* can carry a host of specialized laboratories and specialists in areas such as microbiology, immunology, xenobiology, and pathology. A *M'Benga* also has numerous surgical, quarantine, low-gravity surgical, and intensive care units as well as enough medical and pharmacological stores for a medium-sized colony of a humanoid species.

Disposition:

The following list of *M'Benga* Class rescue ships shows their hull numbers, name, model designation, date entering service, and current disposition. The disposition is represented by the letter codes given below and is followed by the date of occurrence, if known.

B: Built

L: Lost, whereabouts unknown

NCC 10000 <i>M'Benga</i>	B 2/8003
NCC 10001 <i>Salk</i>	B 2/8112
NCC 10002 <i>Steuben</i>	B 2/8202
NCC 10003 <i>Pasteur</i>	B 2/8303
NCC 10004 <i>Voris</i>	B 2/8410
NCC 10005 <i>Crenshaw</i>	B 2/8511 L 2/8511
NCC 10006 <i>Shenvala</i>	B 2/8604
NCC 10007 <i>Barnard</i>	B 2/8708
NCC 10008 <i>Watson</i>	B 2/8911
NCC 10009 <i>Crick</i>	B 2/9102
NCC 10010 <i>Van Gelder</i>	B 2/9205
NCC 10011 <i>T'Klyrn</i>	B 2/9303
NCC 10012 <i>Hopewell</i>	B 2/9406

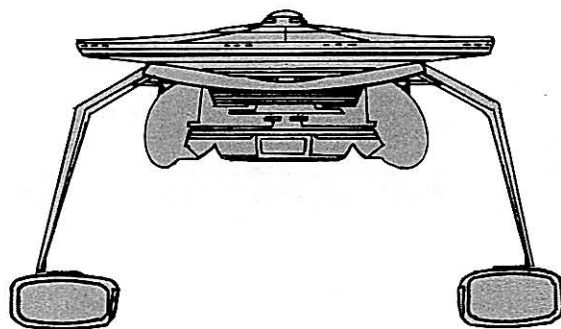
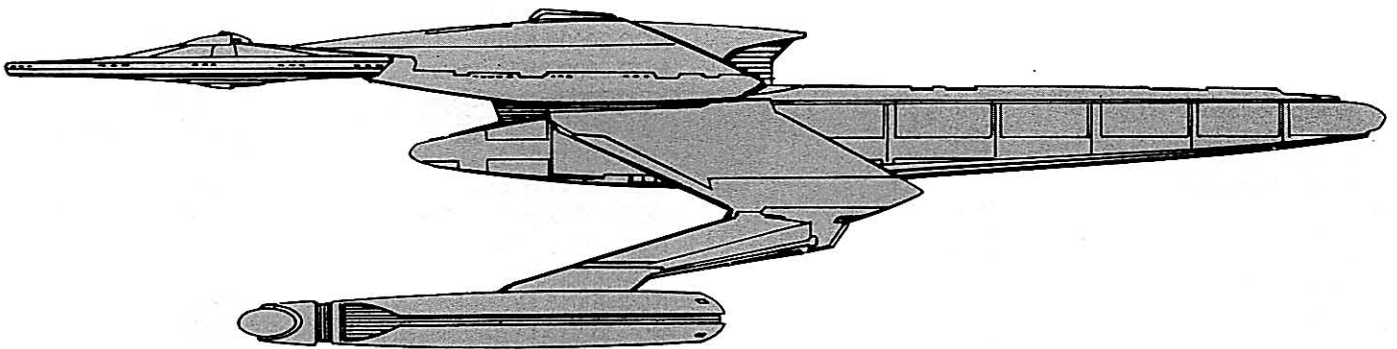
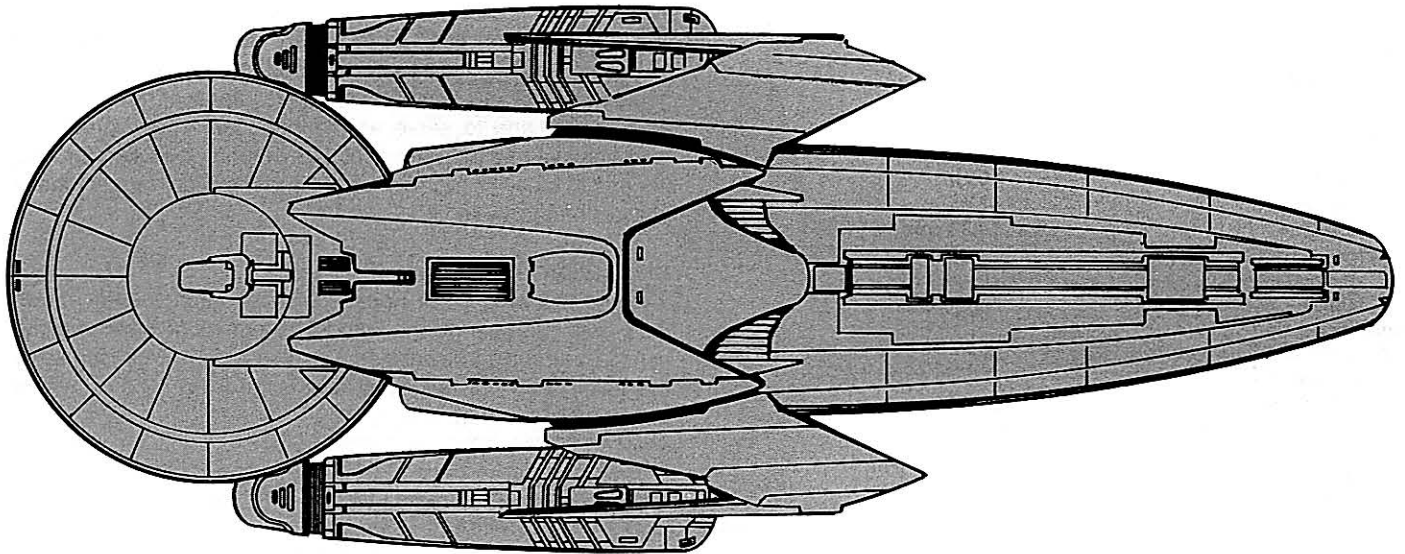

SAGAN CLASS V SCIENCE RESEARCH VESSEL

Construction Data:

Model Number—	1
Date Entering Service—	2/8502
Number Constructed—	17

Hull Data:

Superstructure Points—	9
Damage Chart—	A
Size	
Length—	180 m
Width—	105 m
Height—	62 m
Weight—	59,335 mt

Cargo

Cargo Units—	100 SCU
Cargo Capacity—	5,000 mt

Equipment Data:

Control Computer Type—	M-1
Transporters—	
standard 6-person	2
combat 12-person	5
cargo, large	2
cargo, small	2

Other Data:

Crew—	80
Mission Specialists—	10
Shuttlecraft—	4

Engines and Power Data:

Total Power Units Available—	30
Movement Point Ratio—	2/1
Warp Engine Type—	FWB-2
Number—	2
Power Units Available—	12
Stress Charts—	M/0
Maximum Safe Cruising Speed—	Warp 8
Emergency Speed—	Warp 9
Impulse Engine Type—	FIB-3
Power Units Available—	6

Weapons and Firing Data:

Beam Weapon Type—	FH-8
Number—	3
Firing Arcs—	2 F/P/S, 1 A
Firing Chart—	T
Maximum Power—	5
Damage Modifiers—	
+2	(1–10)
+1	(11–18)

Shields Data:

Deflector Shield Type—	FSF
Shield Point Ratio—	1/2
Maximum Shield Power—	10

Combat Efficiency:

D—	92.87
WDF—	12.90

Notes:

Conceived as an improvement on the weak *Gagarin* Class science vessel, the *Sagan* deep-space science and research vessel has improved power, shielding, and weaponry so that it can better defend itself if necessary during the course of a mission. The *Sagan* Class is designed to provide an extensive geological, biological, and cartographic survey of newly discovered worlds and to serve as manned deep-space probes of astronomical and astrophysical phenomena on station for long periods of time. Though no longer in production, most of these vessels remain in service.

Disposition:

The following list of *Sagan* Class research vessels shows their hull numbers, name, model designation, date entering service, and current disposition. The disposition is represented by the letter codes given below and is followed by the date of occurrence, if known.

B: Built

L: Lost, whereabouts unknown

NCC 20000 <i>Sagan</i>	B 2/8502
NCC 20001 <i>Tsiolkovsky</i>	B 2/8603 L 3/0305
NCC 20002 <i>Carson</i>	B 2/8712
NCC 20003 <i>Meade</i>	B 2/8803
NCC 20004 <i>Einstein</i>	B 2/8804
NCC 20005 <i>Cochrane</i>	B 2/8805
NCC 20006 <i>Fermi</i>	B 2/8806
NCC 20007 <i>V'Ryugenn</i>	B 2/8812
NCC 20008 <i>Mendeleyev</i>	B 2/8905
NCC 20009 <i>Surishian</i>	B 2/8911 L 2/9412
NCC 20010 <i>T'mirea</i>	B 2/9004
NCC 20011 <i>Skoatar</i>	B 2/9105
NCC 20012 <i>Shoonedev</i>	B 2/9512 L 2/9603
NCC 20013 <i>Lowell</i>	B 2/9305
NCC 20014 <i>Daystrom</i>	B 2/9407
NCC 20015 <i>Crater</i>	B 2/9507
NCC 20016 <i>Corby</i>	B 2/9608

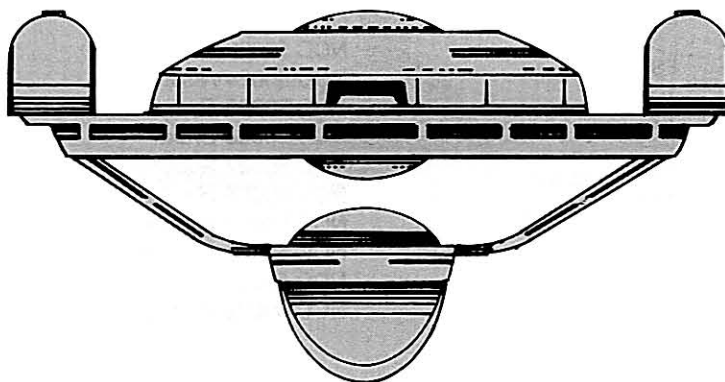
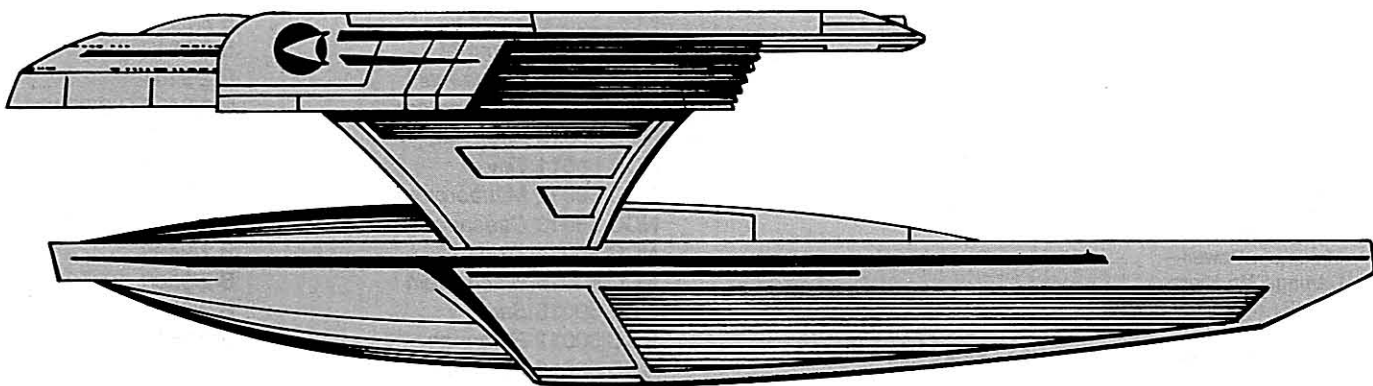
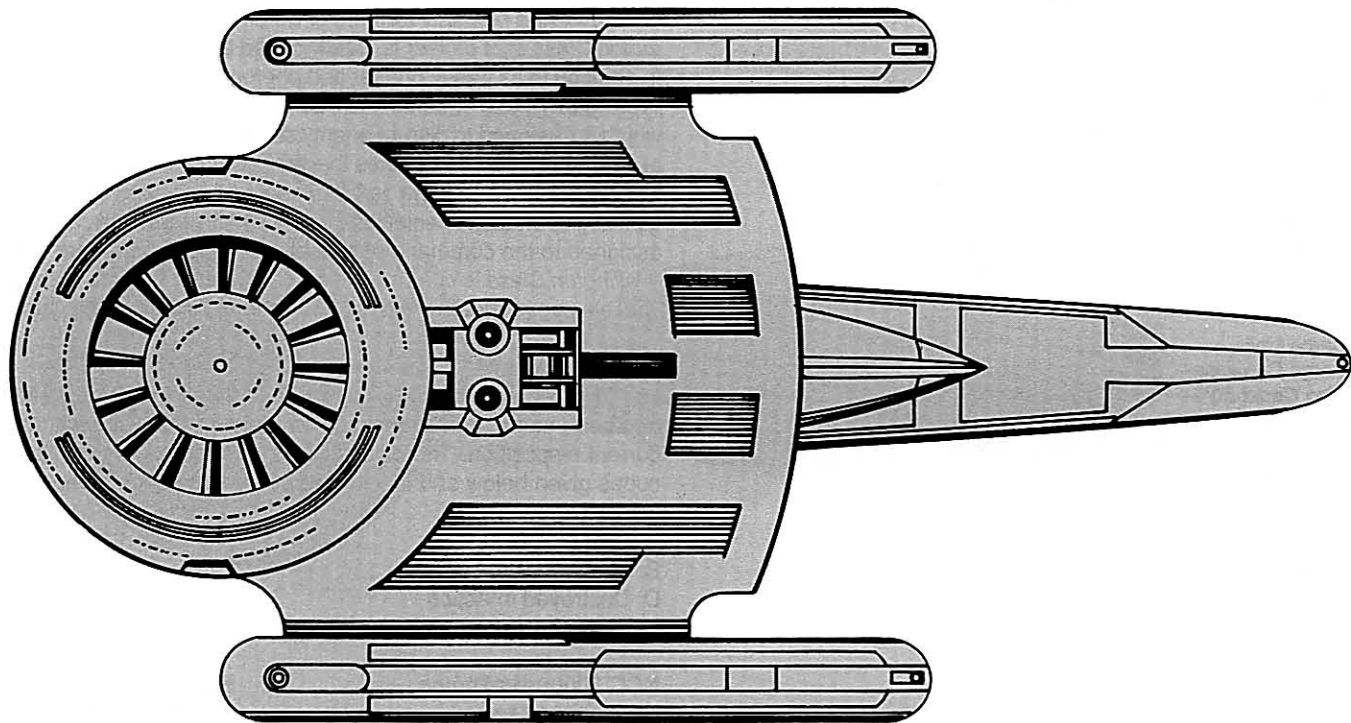

WELLINGTON CLASS XI TRANSWARP LIGHT CRUISER 44

WELLINGTON CLASS XI TRANSWARP LIGHT CRUISER

Construction Data:

Model Number—	1
Date Entering Service—	2/8802
Number Constructed—	33

Hull Data:

Superstructure Points—	28
Damage Chart—	B
Size	
Length—	175m
Width—	62m
Height—	37m
Weight—	165,475 mt

Cargo

Cargo Units—	100 SCU
Cargo Capacity—	5,000 mt
Landing Capability—	No

Equipment Data:

Control Computer Type—	M-7A
Transporters—	
standard 6-person	3
combat 12-person	2
cargo, large	2
cargo, small	2

Other Data:

Crew—	175
Marines—	50
Shuttlecraft—	4

Engines and Power Data:

Total Power Units Available—	64
Movement Point Ratio—	5/1
Warp Engine Type—	FTWC-1
Number—	2
Power Units Available—	20
Stress Charts—	D/E
Maximum Safe Cruising Speed—	Warp 12
Emergency Speed—	Warp 14
Impulse Engine Type—	FIG-1
Power Units Available—	24

Weapons and Firing Data:

Beam Weapon Type—	FH-9
Number—	6 in three banks of 2
Firing Arcs—	2 f/p/s, 2/s, 2/p
Firing Chart—	X
Maximum Power—	6
Damage Modifiers—	
+2	(1–12)
+1	(13–22)
Missile Weapon Type—	FP-4 Photon Torpedo
Number—	5
Firing Arcs—	2 f/p/s, 1/s, 1/p, 1/a
Firing Chart—	S
Power to Arm—	1
Damage—	20

Shields Data:

Deflector Shield Type—	FSO
Shield Point Ratio—	1/3
Maximum Shield Power—	16

Combat Efficiency:

D—	145.04
WDF—	98.5

Notes:

Designed primarily for frontier defense command, the *Wellington* Class light cruiser is ideally suited as a "trip-wire" vessel. In addition to its heavy phaser and photon torpedo batteries, the *Wellington* Class mounts the "Long Lance" plasma torpedo, which is designed to disrupt enemy sensors and control systems at extreme range. This makes the *Wellington* a formidable opponent against all but the largest enemy vessels. *Wellingtons* typically operate in special task groups of three vessels, and are assigned to the command of a local star base commander. The *Wellington* Class is currently being produced at the rate of three vessels per year at the Vannis, Troyis, and Argellius Shipyards.

Disposition:

The following list of *Wellington* Class cruisers shows their hull numbers, name, model designation, date entering service, and current disposition. The disposition is represented by the letter codes given below and is followed by the date of occurrence, if known.

B: Built

D: Destroyed in Action

L: Lost, whereabouts unknown

NCC 50000 <i>Wellington</i>	B 2/8802
NCC 50001 <i>Blucher</i>	B 2/8808 L 2/8904
NCC 50002 <i>Napoleon</i>	B 2/8904
NCC 50003 <i>Coloredo</i>	B 2/8912
NCC 50004 <i>Cordoba</i>	B 2/9002 D 2/9908
NCC 50005 <i>Bellisarius</i>	B 2/9005
NCC 50006 <i>Garth II</i>	B 2/9007
NCC 50007 <i>Rommel</i>	B 2/9010
NCC 50008 <i>Mordaecai</i>	B 2/9104
NCC 50009 <i>Montgomery</i>	B 2/9108 D 2/9202
NCC 50010 <i>Adolphus</i>	B 2/9112
NCC 50011 <i>Tilly</i>	B 2/9205
NCC 50012 <i>Marlborough</i>	B 2/9306
NCC 50013 <i>Caesaria</i>	B 2/9406 D 2/9105
NCC 50014 <i>Trogan</i>	B 2/9408
NCC 50015 <i>Wallenstein</i>	B 2/9503
NCC 50016 <i>Saxe</i>	B 2/9507
NCC 50017 <i>R'dannan</i>	B 2/9511
NCC 50018 <i>Lur'Shann</i>	B 2/9602
NCC 50019 <i>Davout</i>	B 2/9605
NCC 50020 <i>Murat</i>	B 2/9609
NCC 50021 <i>Nathaniel Green</i>	B 2/9612
NCC 50022 <i>Uxbridge</i>	B 2/9704
NCC 50023 <i>Ney</i>	B 2/9708
NCC 50024 <i>Nelson</i>	B 2/9711
NCC 50025 <i>Carver</i>	B 2/9802
NCC 50026 <i>Drake</i>	B 2/9805
NCC 50027 <i>Apollinari</i>	B 2/9808
NCC 50028 <i>Hawkins</i>	B 2/9812
NCC 50029 <i>Bagration</i>	B 2/9904
NCC 50030 <i>Barclay d'Tolly</i>	B 2/9907
NCC 50031 <i>Manstein</i>	B 2/9910
NCC 50032 <i>Patton II</i>	B 2/9912

WELLINGTON CLASS XI TRANSWARP LIGHT CRUISER 45

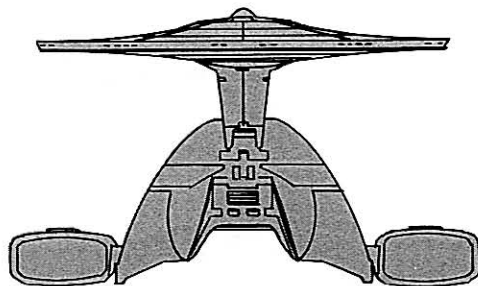
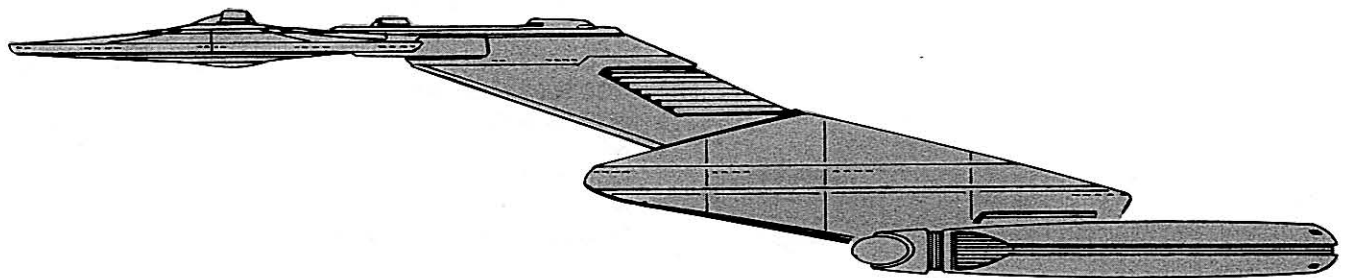
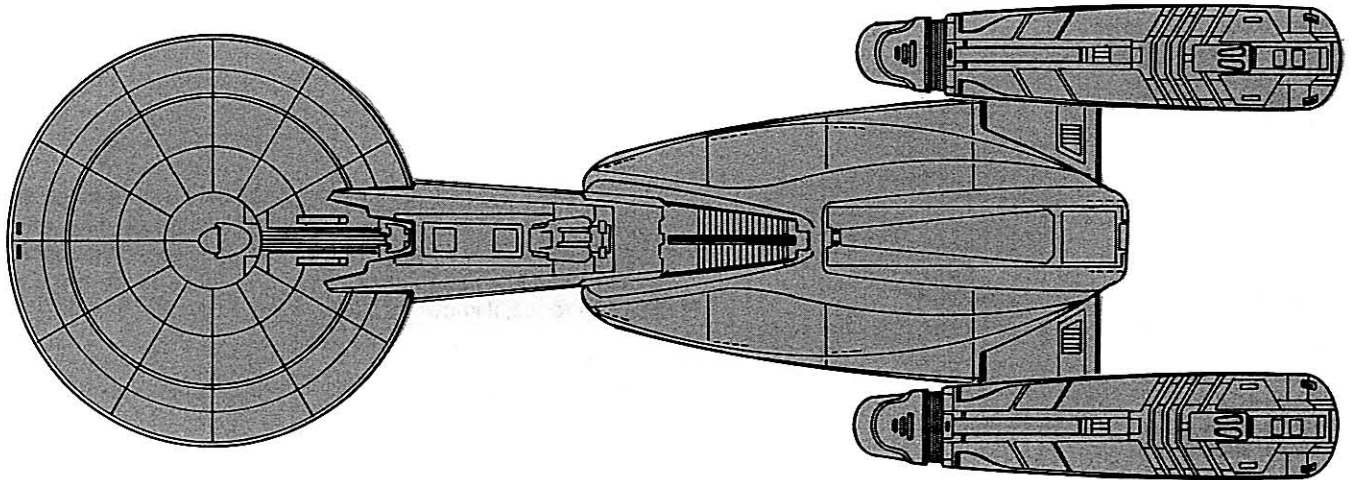

PAINE CLASS IX TRANSWARP FRIGATE

Construction Data:

Model Number—	A
Date Entering Service—	2/9002
Number Constructed—	25

Hull Data:

Superstructure Points—	17
Damage Chart—	C
Size	
Length—	250 m
Width—	120m
Height—	80m
Weight—	139,805 mt

Cargo

Cargo Units—	10 SCU
Cargo Capacity—	500 mt
Landing Capability—	No

Equipment Data:

Control Computer Type—	M-7
Transporters—	
standard 6-person	2
combat 12-person	2
cargo, large	1
cargo, small	1

Other Data:

Crew—	85
Passengers—	15
Shuttlecraft—	3

Engines and Power Data:

Total Power Units Available—	46
Movement Point Ratio—	4/1
Warp Engine Type—	FTWC-1
Number—	2
Power Units Available—	20
Stress Charts—	D/E
Maximum Safe Cruising Speed—	Warp 12
Emergency Speed—	Warp 14
Impulse Engine Type—	FIB-3
Power Units Available—	6

Weapons and Firing Data:

Beam Weapon Type—	FH-9
Number—	3
Firing Arcs—	2f/p/s, 1a
Firing Chart—	N
+2	(1-7)
+3	(8-13)
Missile Weapon Type—	FP7
Number—	3
Firing Arc—	2f/p/s, 1a
Firing Chart—	R
Power to Arm—	1
Damage—	8

Shields Data:

Deflector Shield Type—	FSC
Shield Point Ratio—	1/3
Maximum Shield Power—	16

Combat Efficiency:

D—	127.81
WDF—	21.3

Notes:

Designed as a forward reconnaissance and forward-fire support platform, *Paine* Class frigates perform a variety of duties, including commerce escort, pirate fighter, sentry, and scout. The *Paine's* firepower and shielding help it to maintain contact with enemy craft while relaying data to the main fleet. The *Paine* is the ship class most often in contact with Ferengi raiders. The *Paine* Class is being constructed at the Deneva and Gibraltar Shipyards at the rate of four per year.

Disposition:

The following list of *Paine* Class transwarp frigates shows their hull numbers, name, model designation, date entering service, and current disposition. The disposition is represented by the letter codes given below and is followed by the date of occurrence, if known.

B: Built

D: Destroyed in Action

L: Lost, whereabouts unknown

R: Refit

NCC 9000 <i>Thomas Paine</i>	B 2/9002
NCC 9001 <i>Constantine Rill</i>	B 2/9005
NCC 9002 <i>Bartholemew Dynass</i>	B 2/9007
NCC 9003 <i>Amalthea Rex</i>	B 2/9010
NCC 9004 <i>Preston King</i>	B 2/9103
NCC 9005 <i>Shanessa</i>	B 2/9107
NCC 9006 <i>Sundrass</i>	B 2/9110 D 2/9901
NCC 9007 <i>Grundjaki</i>	B 2/9204 D 2/9805
NCC 9008 <i>Paul Gable</i>	B 2/9301
NCC 9009 <i>Falmor Hann</i>	B 2/9305 L 2/9706
NCC 9010 <i>Halcyon</i>	B 2/9310 L 2/9706
NCC 9011 <i>Christopher Dundas</i>	B 2/9405
NCC 9012 <i>Canadara</i>	B 2/9501
NCC 9013 <i>Carla Winterspoon</i>	B 2/9507
NCC 9014 <i>Drakendesh</i>	B 2/9602 Re 2/9805
NCC 9015 <i>Sedgemoor Tann</i>	B 2/9608 Re 2/9806
NCC 9016 <i>Samantha Elass</i>	B 2/9701
NCC 9017 <i>Tamara</i>	B 2/9707
NCC 9018 <i>Pride of Elass</i>	B 2/9712
NCC 9019 <i>Pride of Troyass</i>	B 2/9804
NCC 9020 <i>Cransston Juriss</i>	B 2/9811
NCC 9021 <i>Qunitaus Gall</i>	B 2/9902
NCC 9022 <i>Ramana Loris</i>	B 2/9908
NCC 9023 <i>Essex Prinn</i>	B 2/9912
NCC 9024 <i>Michael Whelan</i>	B 3/0207

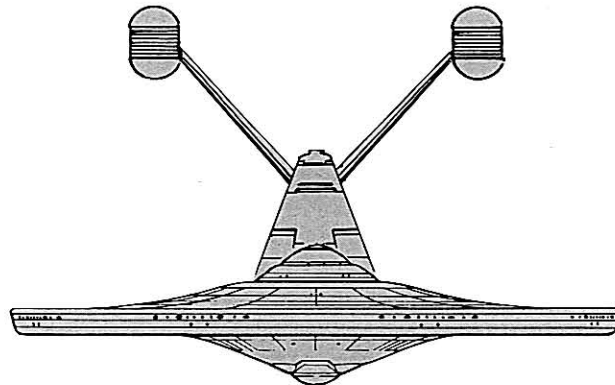
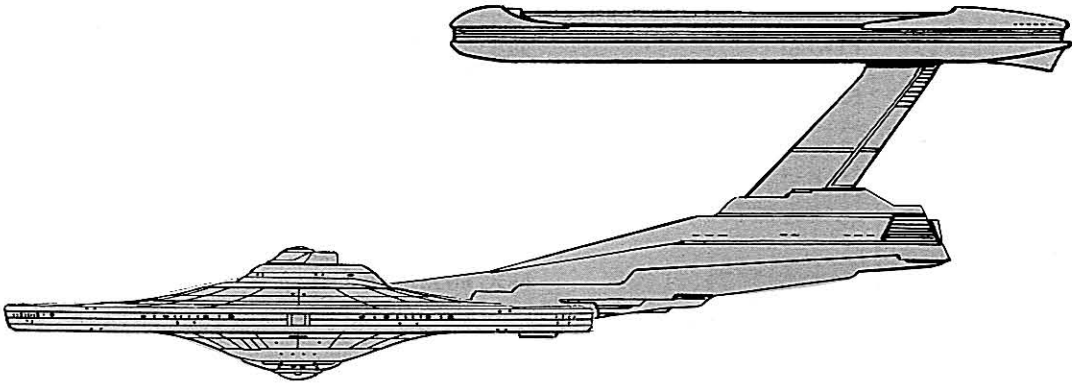
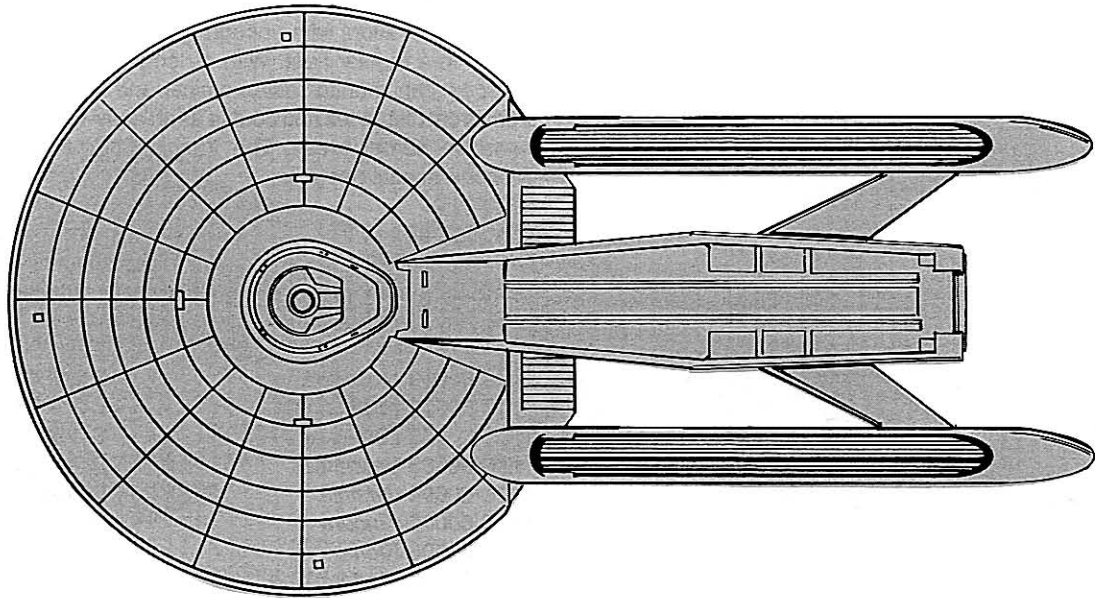

MOSCOW CLASS IX TRANSWARP SCOUT

Construction Data:

Model Number—	Mark I
Date Entering Service—	2/9004
Number Constructed—	22

Hull Data:

Superstructure Points—	17
Damage Chart—	C
Size	
Length—	155 m
Width—	45 m
Height—	35 m
Weight—	123,193 mt

Cargo

Cargo Units—	50 SCU
Cargo Capacity—	2500 mt
Landing Capability—	None

Equipment Data:

Control Computer Type—	M-7
Transporters—	
standard 6-person	2
combat 12-person	2
cargo, large	1
cargo, small	1

Other Data:

Crew—	45
Passengers—	5
Shuttlecraft—	2

Engines and Power Data:

Total Power Units Available—	64
Movement Point Ratio—	6/1
Warp Engine Type—	FTWA-2
Number—	1
Power Units Available—	52
Stress Charts—	D/F
Maximum Safe Cruising Speed—	Warp 12
Emergency Speed—	Warp 14
Impulse Engine Type—	FIF-1
Power Units Available—	12

Weapons and Firing Data:

Beam Weapon Type—	FH-8
Number—	4
Firing Arcs—	2 f/p/s, 1 s/a, 1 p/a
Firing Chart—	T
Maximum Power—	5
Damage Modifiers—	
+2	(1–10)
+1	(11–18)
Missile Weapon Type—	FP-7
Number—	4
Firing Arcs—	2 f/p/s, 2 a/p/a
Firing Chart—	R
Power to Arm—	1
Damage—	8

Shields Data:

Deflector Shield Type—	FSN
Shield Point Ratio—	1/2
Maximum Shield Power—	16

Combat Efficiency:

D—	71.31
WDF—	36.4

Notes:

The *Moscow* Class scout is a dual-purpose vessel for deep-space exploration, with enough firepower to serve as a combat vessel in a regular fleet. With its long-range sensor arrays, the *Moscow* can monitor astronomical and planetary phenomena from great distances and double as an early-warning vessel along sensitive border areas. The Vannis Shipyards produce three *Moscow* scouts per year.

Disposition:

The following list of *Moscow* Class scouts shows their hull numbers, name, model designation, date entering service, and date they were built.

NCC 60000 <i>Moscow</i>	B 2/9004
NCC 60001 <i>Argana</i>	B 2/9005
NCC 60002 <i>Leningrad</i>	B 2/9011
NCC 60003 <i>Balthamar</i>	B 2/9103
NCC 60004 <i>Jursinia</i>	B 2/9106
NCC 60005 <i>Kincara</i>	B 2/9108
NCC 60006 <i>Kloris</i>	B 2/9207
NCC 60007 <i>Mattermaine</i>	B 2/9302
NCC 60008 <i>Oslo</i>	B 2/9404
NCC 60009 <i>Chirpenitar</i>	B 2/9505
NCC 60010 <i>Murigami</i>	B 2/9507
NCC 60011 <i>Quiberon</i>	B 2/9603
NCC 60012 <i>Loris</i>	B 2/9608
NCC 60013 <i>Hadsenn</i>	B 2/9610
NCC 60014 <i>Silimari</i>	B 2/9705
NCC 60015 <i>Hadley</i>	B 2/9710
NCC 60016 <i>Florence</i>	B 2/9712
NCC 60017 <i>Milano</i>	B 2/9804
NCC 60018 <i>Stockholm</i>	B 2/9807
NCC 60019 <i>Ambergris</i>	B 2/9810
NCC 60020 <i>Oudinard</i>	B 2/9902
NCC 60021 <i>Petersburg</i>	B 3/0002

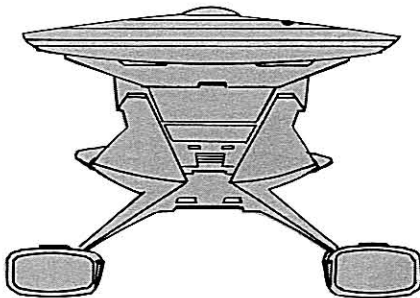
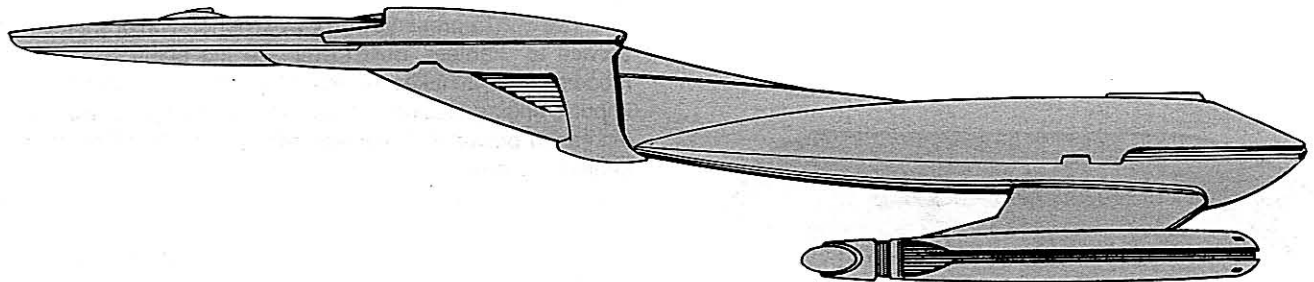
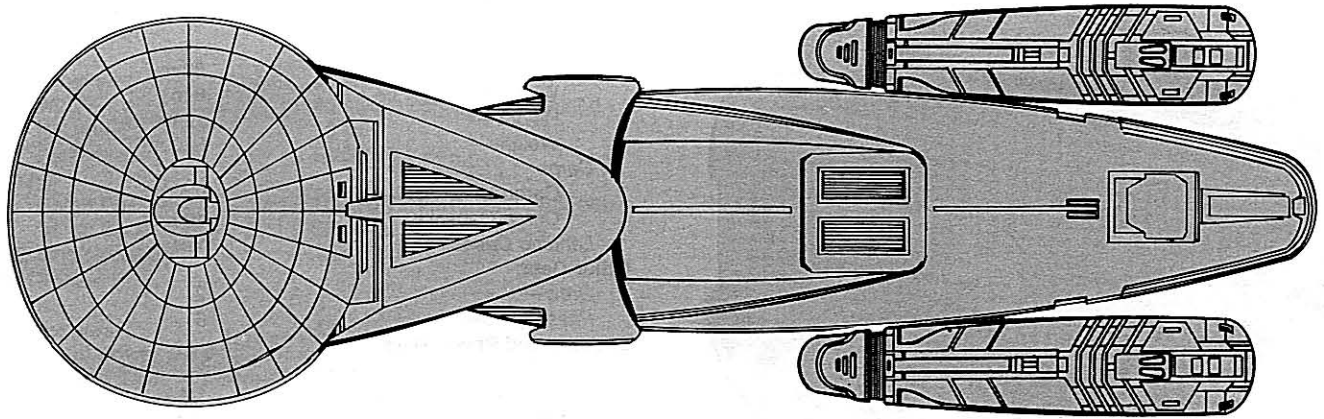

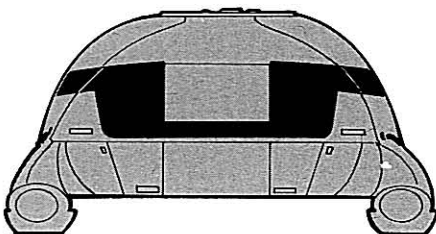
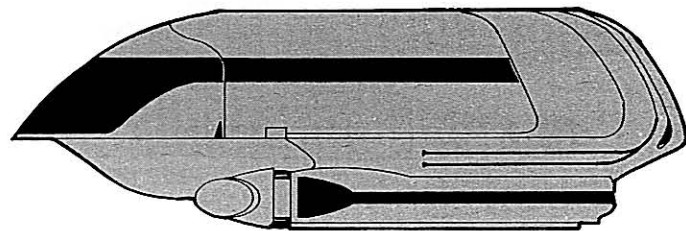
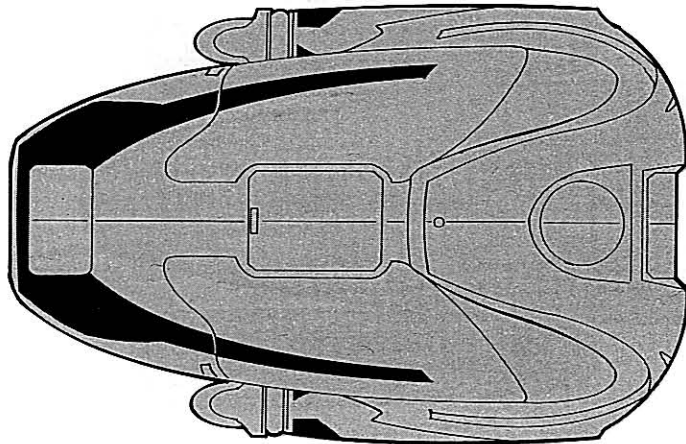

S-20 STANDARD ADMINISTRATIVE SHUTTLE

Construction Data:

Model Number—	II
Date Entering Service—	2/9507
Approx. Number Constructed—	3,000

Hull Data:

Superstructure Points—	1
Damage Chart—	C
Size	
Length—	30 m
Width—	8 m
Height—	12 m
Weight—	820 mt

Cargo

Cargo Units	2 SCU
Cargo Capacity	100 mt
Landing Capability—	Yes

Other Data:

Crew—	2
Passengers—	6

Engines and Power Data:

Total Power Units Available—	3
Movement Point Ratio—	1/4
Impulse Engine Type—	FMIB-3
Power Units Available—	3

Shields Data:

Deflector Shield Type—	Enhanced Navigational Deflectors Only
Shield Strength—	2

Notes:

The S-20 represents the newest generation of shuttlecraft in service to Starfleet. Built to replace the aging S-7 and S-10 models, the S-20 takes full advantage of the new FMIB-3 micro-impulse engine, trading minimal increases in space allocation for increased power and maneuverability. Starfleet Command recently rejected a Zaranite proposal to arm the S-20, continuing the centuries-old Federation policy of not arming administrative shuttles. They opted instead to strengthen the vessel's navigational deflector system for improved shielding capability. The S-20 has won high praise in both military and civilian circles for its versatility and endurance. Its environmental and life-support systems are of modular design, simplifying modification for particularly hazardous duty when no parent craft is present. The shuttle's new computer systems are also capable of linking with standard star base and ground navigational control systems.

SC-22 SPHINX CLASS CARGO SHUTTLE

Construction Data:

Model Number—	1
Date Entering Service—	2/9704
Number Constructed—	945

Hull Data:

Superstructure Points—	2
Damage Chart—	C
Size	
Length—	45 m
Width—	80 m with cargo pods attached
Height—	16 m
Weight—	5,200 mt

Cargo

Cargo Units—	100 SCU in four trailing cargo pods
Cargo Capacity—	5,000 mt
Landing Capability—	Yes

Other Data:

Crew—	2
Passengers—	4

Engines and Power Data:

Total Power Units Available—	3
Movement Point Ratio—	1/1 unloaded
Impulse Engine Type—	FMIB-3
Power Units Available—	3

Shields Data:

Deflector Shield Type—	Navigational Deflectors Only
------------------------	------------------------------

Notes:

Deriving its name from its vaguely leonine shape, this Andorian design *Sphinx* is a miniature version of the much larger cargo transports used extensively by Starfleet. With its oval duraplast command cockpit, which gives the crew a 240-degree view, this craft is a readily identifiable sight around all but the most remote Starfleet installations. Used primarily in support of ground-based facilities and on larger vessels, the *Sphinx* Class shuttle's cargo pods are slung under the belly of the craft for transporting cargos either too unstable or too bulky for normal transporter transit. Each cargo pod can carry 25 standard cargo units, and the craft can haul up to four such pods and can jettison them individually, if necessary.

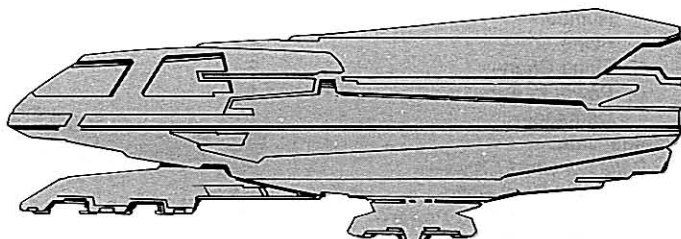
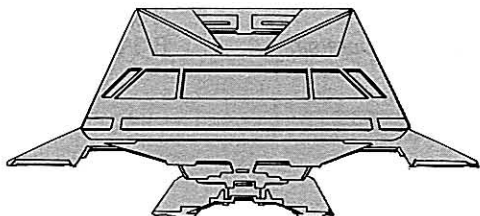
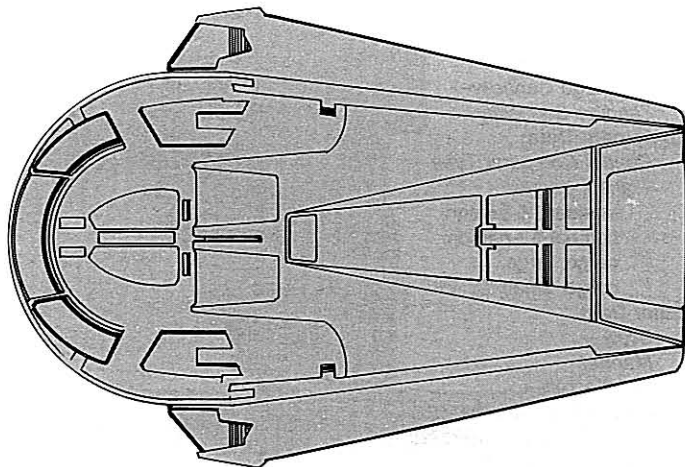

AMBASSADOR TRANSWARP HEAVY CRUISER

Construction Data:

Model Number—	1
Date Entering Service—	2/9912
Number Constructed—	15

Hull Data:

Superstructure Points—	70
Damage Chart—	C
Size	
Length—	350 m
Width—	200 m
Height—	100 m
Weight—	286,605 mt

Cargo

Cargo Units—	200 SCU
Cargo Capacity—	10,000 mt
Landing Capability—	No

Equipment Data:

Control Computer Type—	M9A
Transporters—	5
standard 6-person	5
combat 12-person	3
cargo, large	1
cargo, small	2

Other Data:

Crew—	400
Marines—	100
Shuttlecraft—	6

Engines and Power Data:

Total Power Units Available—	112
Movement Point Ratio—	5/1
Warp Engine Type—	FTWD-2
Number—	2
Power Units Available—	40
Stress Charts—	E/F
Maximum Safe Cruising Speed—	Warp 12
Emergency Speed—	Warp 14
Impulse Engine Type—	FIG-2
Power Units Available—	32

Weapons and Firing Data:

Beam Weapon Type—	FH-11
Number—	8
Firing Arcs—	2f, 2/p, 2/s, 2/a
Firing Chart—	Y
Maximum Power—	10
Damage Modifiers—	
+3	(1–10)
+2	(11–17)
+1	(18–24)
Missile Weapon Type—	FP-4
Number—	10
Firing Arc—	4f, 2f/p, 2f/s, 2a
Firing Chart—	S
Power to Arm—	1
Damage—	20

Shields Data:

Deflector Shield Type—	FSQ
Shield Point Ratio—	1/4
Maximum Shield Power—	17

Combat Efficiency:

D—	240.1
WDF—	210.6

Notes:

The newest heavy cruiser in Starfleet, the *Ambassador* Class is designed to provide close fire support for major task groups, especially when Federation vessels are outnumbered. Armed with heavy long-range phasers and a large complement of photon torpedoes, ships of this class are formidable foes that can engage the enemy at long range. They are also able to inflict moderate damage and lend direct fire support from virtually any tactical position within a flotilla or attack group. The *Ambassador* Class also supports a full complement of marines trained in zero-gravity combat and boarding maneuvers, which further enhances its worth as a combat vessel. The *Ambassador* Class is distinctive in appearance as well. The *Ambassador* has transwarp drive nacelles to port and starboard attached to the rear of the vessel. Argelius Shipyards produces three *Ambassadors* per year. Ships of this class are named for individuals who have made significant contributions to the Federation in recent years.

Disposition:

The following list of *Ambassador* Class cruisers shows their hull numbers, name, model designation, date entering service, and current disposition. The disposition is represented by the letter codes given below and is followed by the date of occurrence, if known.

B: Built
D: Destroyed in Action
L: Lost, whereabouts unknown
R: Refit

NCC 8000 <i>Ambassador Hardin</i>	B 2/9912
NCC 8001 <i>Danton Abrams</i>	B 3/0002
NCC 8002 <i>Horatio Ballantrye</i>	B 3/0004 D 3/0304
NCC 8003 <i>President Survil</i>	B 3/0008 Re 3/0301
NCC 8004 <i>Admiral Carnes</i>	B 3/0012 Re 3/0301
NCC 8005 <i>Patricia Prince</i>	B 3/0103
NCC 8006 <i>Beth Bigelow</i>	B 3/0107
NCC 8007 <i>General A'thak</i>	B 3/0111
NCC 8008 <i>Ambassador Crane</i>	B 3/0112 L 3/0207
NCC 8009 <i>Governor Gallas</i>	B 3/0202
NCC 8010 <i>Fiona Vincent</i>	B 3/0205
NCC 8011 <i>Garnash Trell</i>	B 3/0208 D 3/0301
NCC 8012 <i>Ibrahim Jones</i>	B 3/0210
NCC 8013 <i>Andalusia Sims</i>	B 3/0212
NCC 8014 <i>Koromondi Carstairs</i>	B 3/0301

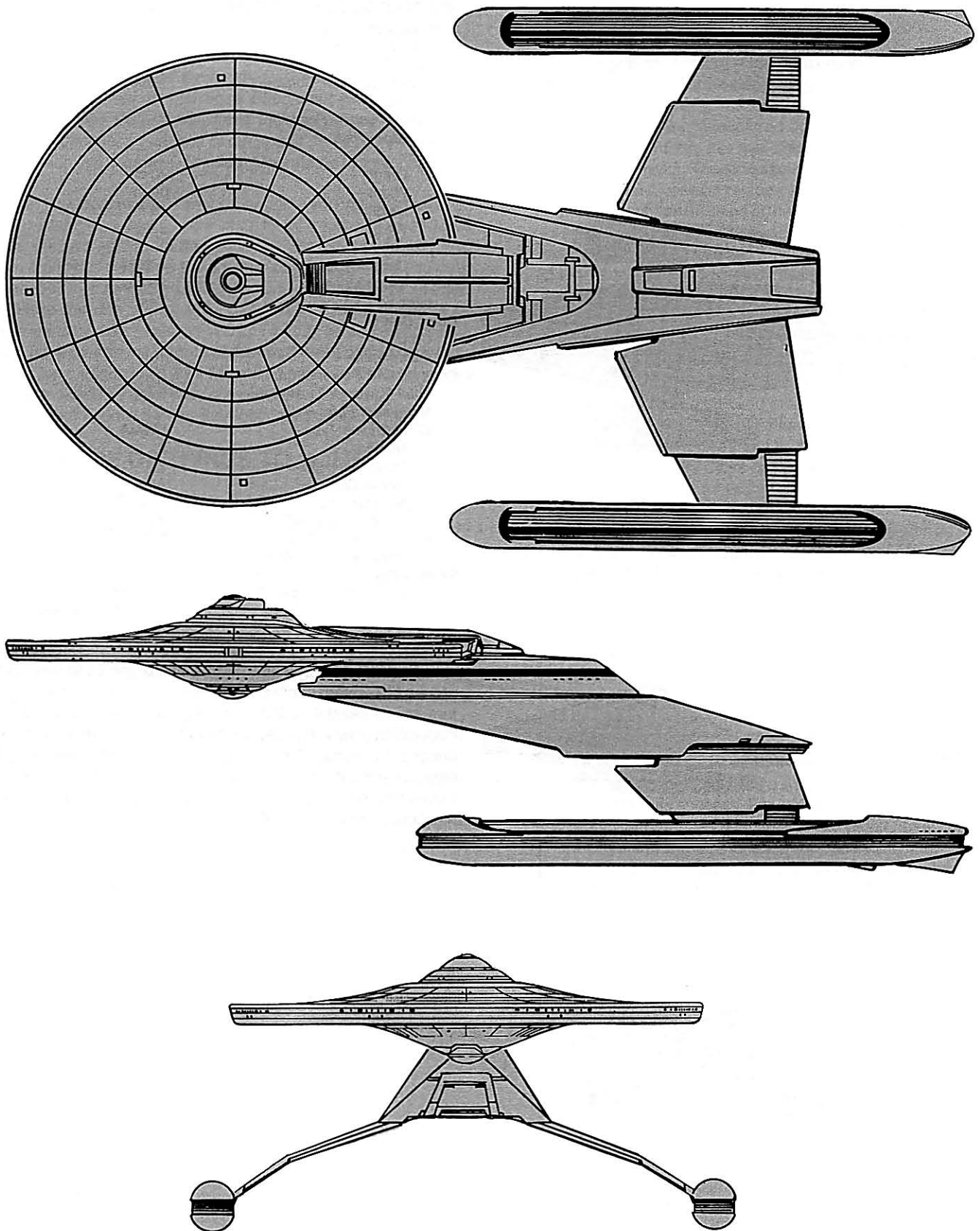

SW-21 LONG-RANGE WARP SHUTTLE

Construction Data:

<i>Model Number—</i>	1
<i>Date Entering Service—</i>	2/9709
<i>Approx. Number Constructed—</i>	1,500

Hull Data:

<i>Superstructure Points—</i>	3
<i>Damage Chart—</i>	C
<i>Size</i>	
Length—	70 m
Width—	30 m
Height—	15 m
Weight—	2360 mt

Cargo

Cargo Units	4 SCU
Cargo Capacity	200 mt

Landing Capability—

Yes

Other Data:

<i>Crew—</i>	2
<i>Passengers—</i>	10

Engines and Power Data:

<i>Total Power Units Available—</i>	5
<i>Movement Point Ratio—</i>	1/1
<i>Warp Engine Type—</i>	FWMA
Number—	2
Power Units Available—	2
Stress Charts—	A/A
Maximum Safe Cruising Speed—	Warp 2
Emergency Speed—	Warp 3
<i>Impulse Engine Type—</i>	FMA-1
Power Units Available—	1

Shields Data:

<i>Deflector Shield Type—</i>	Enhanced Navigational Deflectors Only
-------------------------------	---------------------------------------

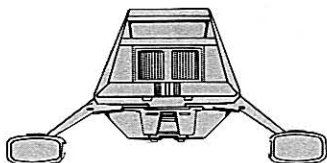
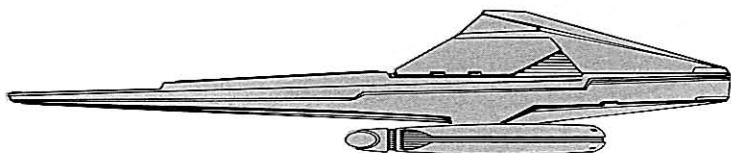
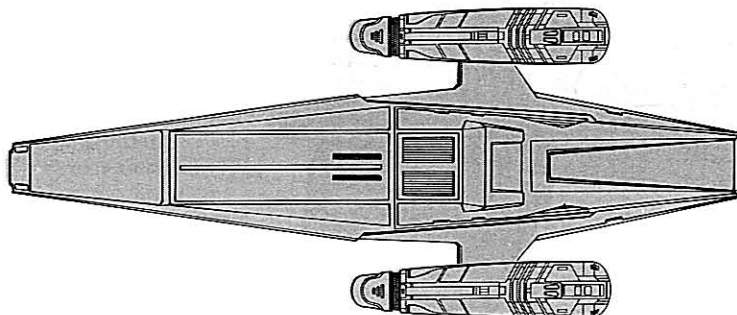

Notes:

The SW-21 is equipped with a micro-engine version of the proven FIA-3 warp engine system and the micro-impulse generators so successful in other starship designs. In keeping with Federation policy, this vessel is unarmed, but carries the same enhanced deflector shield as does the S-20 shuttle. Replacing the older warp shuttle systems, the SW-21 is so easily modified that numerous commercial variants exist, including medical, communications, and rescue craft.

GALAXY CLASS EXPLORATION CRUISER 55

It is a question of necessity, because we are presently unable to be in all places at all times with the needed force to counter all threats. What we need is something that will frighten our enemies away from territory once and for all. The new Galaxy Class is just such an instrument of deterrence. Should our efforts to maintain peace fail, the Galaxy will make the enemy pay the highest possible price for incursions of our space.

—Admiral Carstairs, Starfleet Operations Planning Board

In your own words, Admiral Carstairs, you indicate that even the militarization of this new ship to its maximum destructive potential will not guarantee peace. I submit to you, sir, that converting this class into the ultimate battlewagon—as you have described it on more than one occasion—may well have an effect opposite the one you desire. The presence of so massive an instrument of deterrence, as you call it, may be perceived by our adversaries as an instrument of destruction beyond all necessity. If you have things your way, launching this new Enterprise may signal a new war, not a new era of peace.

—Commodore Santin, Starfleet Operations Planning Board

THE SHAPE OF THINGS TO COME

As the culmination of years of design and development, the Galaxy Class exploration cruiser incorporates hundreds of technological advances. In light of recent losses of Starfleet exploration vessels probing the coreward sphere of the galaxy, this new ship class fills the need for a well-armed craft able to deal with the unexpected.

The *USS Enterprise* boasts a variety of radical design changes and is the largest vessel in the fleet. The Galaxy Class uses a revolutionary FIF-2M multi-warp, field-generating propulsion system capable of speeds well in excess of even the fastest transwarp vessel.

As with earlier ships designs from the Chiokis and Shuvinglass Shipyards, the *Enterprise* has a saucer-shaped command section and a main drive section. In emergency situations, most of the ship's complement can move to the command saucer section, which is able to detach for independent flight. This leaves the drive section, containing most of the ship's armaments, to fight under separate combat control from an emergency battle bridge.

A distinctive aspect of this design is the provision for up to a thousand civilians, including the families of duty personnel. Transporting civilians aboard a vessel whose role is military has generated controversy among high-ranking fleet officers. Some argue that the presence of family members increases morale and efficiency on the Galaxy's typically long-term missions, while others object to exposing civilians to the dangers implicit in deep-space missions.

MISSION STATEMENT

The primary mission of the Galaxy Class cruiser is to expand the frontiers of the Federation through exploration, with emphasis on operations among the central cluster of star systems. In addition to charting unexplored space and investigating astronomical phenomena, this new ship is equipped to make contact with new life forms. These vessels are designed for tours of duty of ten to twelve years in regions far from Star Fleet installations.

The secondary mission of these ships and their crews is to act as representatives of the United Federation of Planets with distant member worlds and their governments. In this role, these vessels could be called upon to provide assistance, military or otherwise, in an emergency.

THE ENTERPRISE LEGACY—NC 1701-C

After the destruction of the *Excelsior Class Enterprise*, NCC 1701-B, Starfleet honored the name of *Enterprise* by assigning it to the most powerful ship to date, the *Alaska Class* battlecruiser. Like the *Excelsior Class*, the *Alaska's* purpose was quite clear: offensive power.

The naming did not go smoothly. There was debate in the Federation Council, initiated by the Vulcans, that the name *Enterprise* was synonymous with exploration, discovery, and the ideals of IDIC, the Vulcan philosophy of Infinite Diversity in Infinite Combinations. The Vulcans argued that giving the name *Enterprise* to a research vessel or Exploration Command cruiser would be a far more logical move.

Starfleet officials listened sympathetically, but the *Alaska Class* nevertheless received the name. On Stardate 2/9301, the *USS Enterprise*, NCC 1701-C was launched.

Unfortunately, giving a ship a noble name does not guarantee its success. For its first five years of service, the *Enterprise* was relegated to dull patrol duties along the Neutral Zone. A chance for the vessel to make a name for itself finally came when Starfleet Command assigned the *Enterprise* to a ten-year Galaxy Exploration mission that would take it beyond the UFP's frontier in the Northwest Quadrant. Starfleet also hoped that the move would appease Vulcan critics who had hoped that the name *Enterprise* would once again be associated with the spirit of exploration.

Two and a half years into its mission, the *Enterprise* sent a distress call to Star Base 67. The *Enterprise* was declared lost and presumed destroyed on Stardate 3/0006.30. What has happened to the ship remains a mystery to this day.

In honor of this tragic loss, Starfleet Command gave the designation NCC 1701-D and the famous name of *USS Enterprise* to the new Galaxy Class exploration vessel. It is hoped that this latest version can uphold the ideals of peace and the quest for knowledge as did its famous counterpart of the early 23rd century.

GENERAL STATISTICS

USS ENTERPRISE

Construction Data:

Model Number—	IA
Date Entering Service—	3/0301
Number Constructed—	2

Hull Data:

Superstructure Points—	98
Damage Chart—	C
Size	
Length—	642.5 m
Width—	467 m
Height—	137.5 m
Weight—	397,805

Cargo

Cargo Units—	500 SCU
Cargo Capacity—	25,000 mt
Landing Capability—	No

Equipment Data:

Control Computer Type—	M-8A Duotronics AICS
Transporters—	
standard 6-person	20
cargo, large	3
cargo, small	5

Other Data:

Crew—	900+
Passengers—	800 max. (300 standard)
Shuttlecraft—	
Sphinx Maintenance	20
Standard 10-man	20
Standard 22-man	4

Engines and Power Data:

Total Power Units Available—	153 (120 w/saucer)
------------------------------	--------------------

Star Drive Section—

Total Power Units Available—	120
Movement Point Ratio—	7/1
Warp Engine Type—	FVWA1
Number—	2 (4)
Power Units Available—	40
Stress Charts—	E/F
Maximum Safe Cruising Speed—	Warp 9*
Emergency Speed—	Warp 10*
Impulse Engine Type—	FIG-3
Power Units Available—	40

Saucer Section (Emergency Disconnection Only)—

Total Power Units Available—	32
Movement Point Ratio—	4/1
Warp Engine Type—	FWH-1B
Number—	1
Power Units Available—	16
Stress Charts—	L/F
Maximum Safe Cruising Speed—	Warp 5
Emergency Speed—	Warp 7
Impulse Engine Type—	FIF-2
Power Units Available—	16

Weapons and Firing Data:

Beam Weapon Type—	FH-15
Number—	8 in four banks of 2
Firing Arcs—	300-degree Collimator Arc f/p/s

Firing Chart—	Y
Maximum Power—	12
Damage Modifiers—	
+3	(1–11)
+2	(12–20)
+1	(21–24)

Beam Weapon Type—

Number—	FH-10
Firing Arcs—	16 in eight banks of 2
Maximum Power—	4f, 4f/p, 4f/s, 4a
Damage Modifiers—	7
+3	(1–10)
+2	(11–17)
+1	(18–20)

Missile Weapon Type—

Number—	FP-10
Number—	20

Main Saucer Section—

Number—	4
Firing Arcs—	4 f/p/s
Firing Chart—	S
Power to Arm—	1
Damage—	20

Star Drive Section—

Number—	16
Firing Arcs—	4 f/p/s, 4/p, 4/s, 4/a
Firing Chart—	S
Power to Arm—	1
Damage—	20

Shields Data:

Deflector Shield Type—	FSQ
Shield Point Ratio—	1/4
Maximum Shield Power—	16

Combat Efficiency:

D—	300+ (est.)
WDF—	250+ (est.)

Operational Capabilities

Cruising Range	25,570
Expected Lifetime	35 standard years
Average Time until Resupply	6.7 standard years
Estimated Time between Refittings	10 standard years

Power Generation:

Primary	Third-Generation Multi-Field Warp Drive
Secondary	Chiokis Fusion Reactors, A-D
Tertiary	Mark-9 Solar Battery Collectors

Power Output:

Maximum Speed	Warp 10*
Interval From Subspace to Warp 1	1.2 microseconds

Computer System:

Type and Manufacturer	Duotronics M-8A AICS Command System
Storage Capacity	125,575,500 terra bytes
Average Response Time	0.3478 nanoseconds

Sensor Systems Capabilities:

Primary Sensor Detector Radius	3.3 parsecs
Automated Telemetry Control Radius	2.5 parsecs

Transporter Range:

	15,000 kilometers direct line-of-sight
--	---

* Ultra Warp velocity

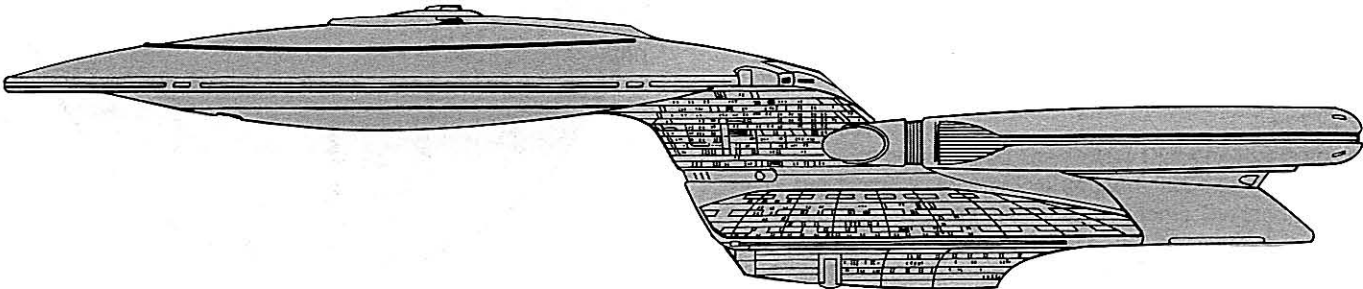
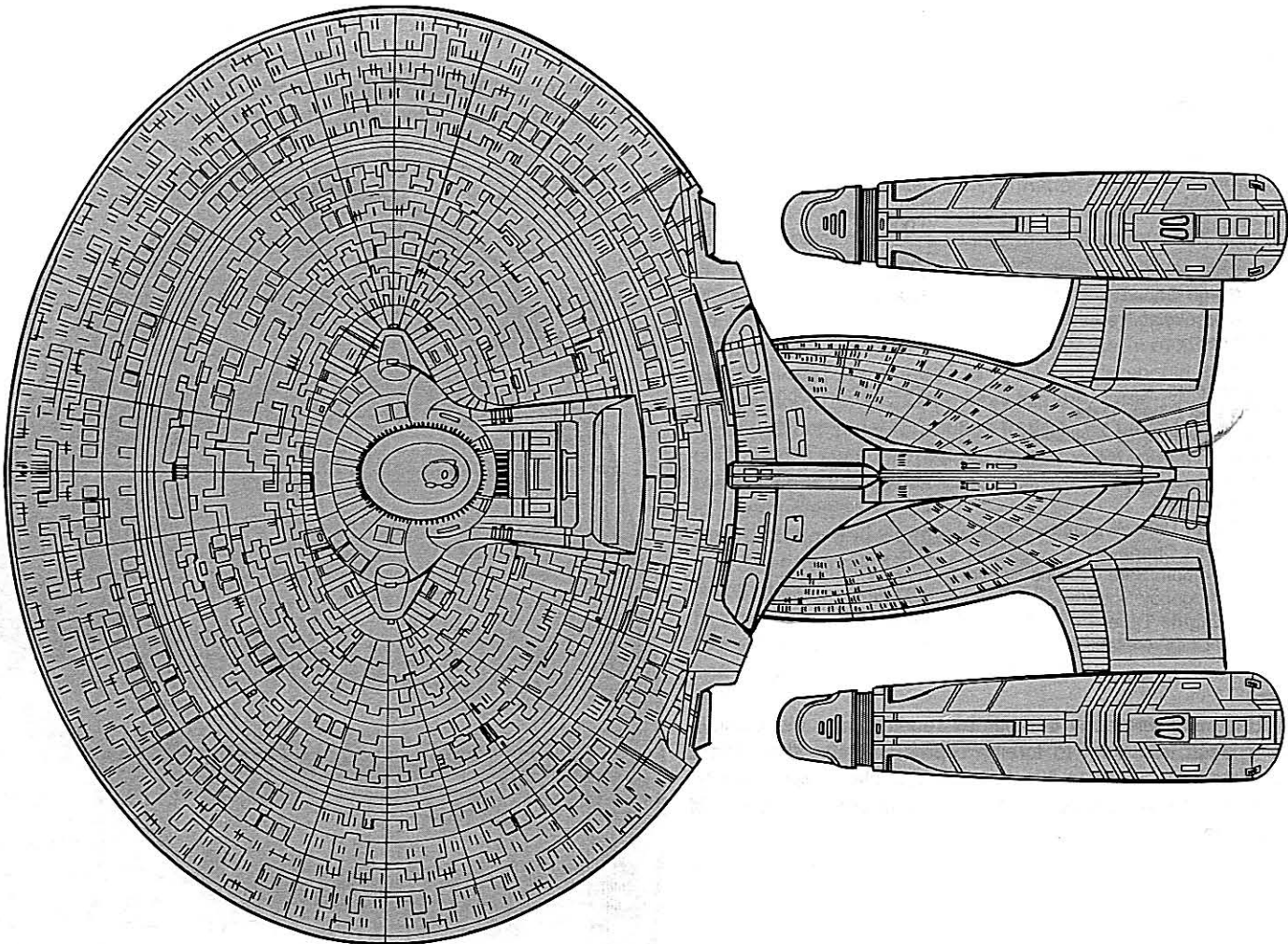

Captain's Yacht

Construction Data:

Model Number—	III
Date Entering Service—	2/8206
Number Constructed—	356

Hull Data:

Superstructure Points—	2
Damage Chart—	C
Size	
Length—	24 m
Width—	42 m
Height—	8 m
Weight—	3,000 mt

Cargo

Cargo Units—	6 SCU
Cargo Capacity—	300 mt
Landing Capability—	Yes

Other Data:

Crew—	2
Passengers—	35

Engines and Power Data:

Total Power Units Available—	9
Movement Point Ratio—	1/1
Warp Engine Type—	FMWC
Number—	2
Power Units Available—	4
Stress Charts—	B/B
Maximum Safe Cruising Speed—	Warp 4
Emergency Speed—	Warp 6

Impulse Engine Type—

FMIA	
Power Units Available—	1

Notes:

Because ceremony sometimes requires that the Captain give special treatment to foreign representatives, the *Galaxy Class* is equipped with a private yacht capable of warp speeds. Equipment on this saucer-shaped craft can create a variety of environmental conditions and synthesize rare foods and drink. It has a plush interior and private viewing image screens for the entertainment of foreign dignitaries.

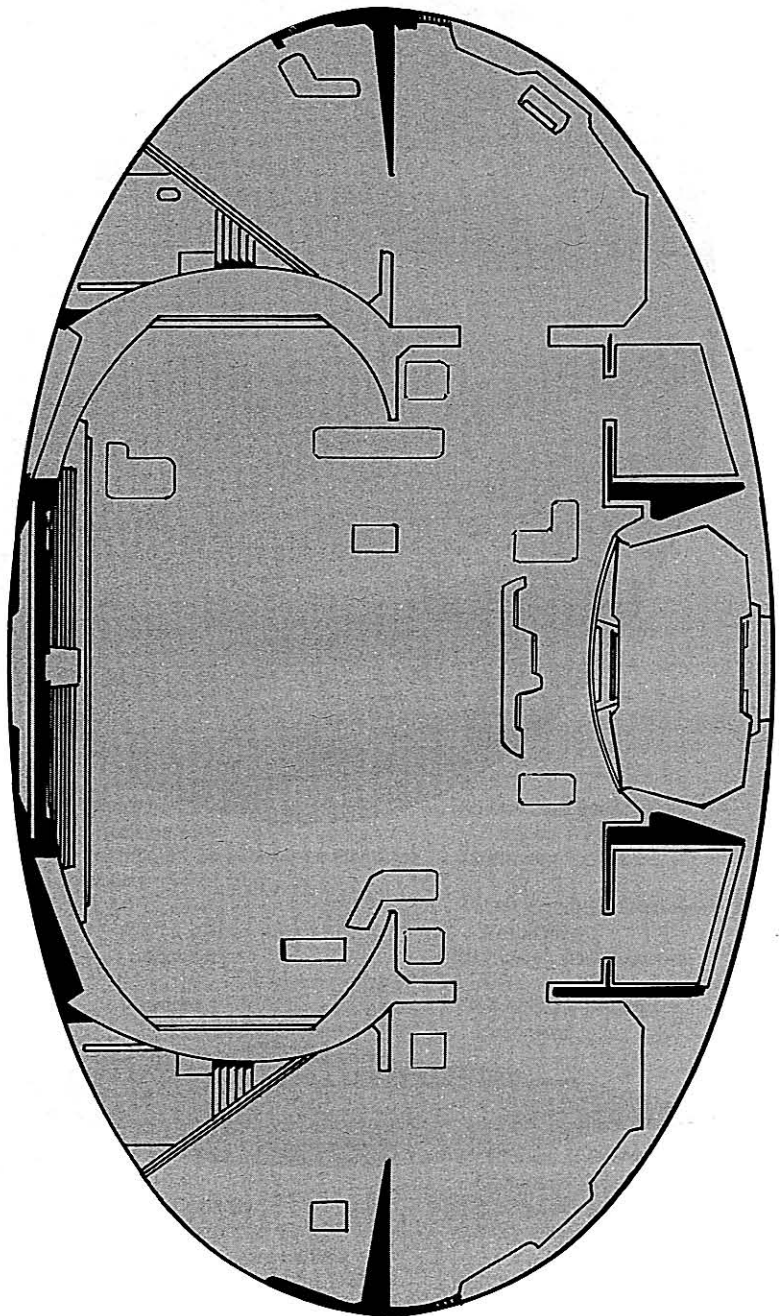

SHIPBOARD FACILITIES

Following is a description of shipboard facilities aboard the *Galaxy Class Exploration Cruiser*.

SAUCER COMMAND SECTION

The Saucer Command Section of the *Galaxy Class* cruiser contains most the ship's command and control systems, along with a variety of scientific, navigational, medical, and support systems. This section also contains living and dining accommodations for the ship's 900 crew members. When detached from the main engineering hull, the saucer section uses a modified FWH-1 warp drive system to achieve independent flight at speeds up to Warp 4.

The command and control nerve center of the *Galaxy Class*, the ship's Main Bridge is located atop the saucer section. It is accessible by two turbolift elevators, permitting rapid crew transfer and reinforcement. Designed for maximum comfort and utility, the Main Bridge has stations for the Captain, Executive Officer, Ship's Counselor, Chief of Security, Science and Engineering monitors, and two Bridge Command Specialists.

The Captain's chair has manual controls to monitor environmental systems, emergency weapons tracking, perimeter defense sensors, and communications (intership and personal log). The Executive Officer, at his station to the right of the Captain, has similar equipment.

Also on the main bridge are the twin Bridge Specialist control stations, designed with duplicate navigational and helm controls as well as direct links to the ship's computer systems and long-range sensor arrays. The duplicate "swing-out" panel stations allow one Bridge Specialist to easily take over from his counterpart in the event of accident or injury. Each station has a direct view of the Main Bridge viewscreen.

The Security station is on the upper deck of the Bridge and overlooks the other stations. It has controls for monitoring communications, contacting security teams, controlling the ship's weapons systems, tracking phaser and photon torpedoes, activating emergency life-support systems, and directing communications with another ship or with a ground installation.

Behind the Security station are the five supplementary control stations for science, engineering, ship's tactical command computer link, and two stations for direct Library Computer Access. The Science station has direct computer access to the ship's extensive library computers, monitors for cataloguing and analysis of sensor data, and controls for ordering computer tests in automated labs. The Engineering Station monitors power and life-support systems and can generate automated diagnostic and system self-test procedures. Though much of the information about the Tactical Command Computer is classified, it provides up-to-the-minute analysis of the vessel's combat status during ship-to-ship engagements as well as conditions affecting Away Teams or security detachments. The Tactical Command Computer also provides situation analysis and combat recommendations.

Ready Room and Main Bridge Conference Rooms

To aft of either side of the main bridge is an adjoining room for private conferences. The ready room can accommodate up to twelve persons and is equipped with computer terminal, three-dimensional display systems, and food processor.

Auxiliary Control Saucer Section

Approximately 7 decks below the Main Bridge is the Auxiliary Control. This station duplicates the equipment of the main bridge so that Flag Bridge crew members can immediately recover control of ship functions if the Main Bridge is damaged.

Transporter Stations

The *Galaxy Class* cruiser contains 20 standard 6-person stations. In addition, 5 large cargo-bay transporters permit rapid transference of bulk materials from surface to ship, and vice versa. Because of innovations in matter alignment systems, the *Galaxy Class* transporters make possible intership beaming of cargo or crew members. Actual control of routine transporter operations is conducted by the ship's central artificial-intelligence control computer, which maintains a constant voice and biofeedback lock on all ship's personnel via the biocommunicator badges worn on duty. Human technicians oversee normal transporter functions and stand ready to react quickly should the system malfunction. Though controversy still surrounds use of the ship's intelligent computer for routine transporter functions, computer control does speed up request-to-beam time. Proponents of the system argue that this increased efficiency could save many lives in an emergency.

Shuttle Bays and Hangar Deck

Aft on the main saucer section and on the engineering hull are two shuttlecraft-receiving and launch bays for the ship's administrative and research shuttles. Two shuttles are kept constantly at ready status, and the rest can be readied in five minutes. Repair and support facilities are also located here.

Nursery

The ship's Nursery is located in the most protected area of the central saucer section. In addition to providing care and recreation for infants, both humanoid and non-humanoid, this facility also houses pediatric medical units.

Education Center

The ship's Crewmaster oversees the teaching facilities and instructors to meet the many demands of a *Galaxy Class* vessel's varied ship's complement. The Education Center offers day care, elementary and secondary schooling, and advanced courses in administrative, scientific, technical, and other disciplines. The center also offers seminars on the different cultural and social systems within the Federation and related courses on social interaction and psychological integration. The quality of education is high enough that every major university in the Federation fully credits the secondary and junior college equivalents offered aboard ship. In addition, personal learning and career development programs offer refresher courses, advanced skill training, and instruction in leisure-time activities. All classrooms and training centers have data relay terminals and three-dimensional holoprojectors with links to the ship's computer systems and library.

Medical Center

As might be expected, the *Galaxy Class* cruiser is equipped with the latest in biomedical support facilities. In addition to standard treatment and examination rooms, the Medical Center has pharmacology, xenobiology, and surgical areas and twelve self-contained quarantine bays. These bays have individual, computer-controlled anti-microbiology screens and quarantine fields that can be engaged to prevent the spread of microorganisms or for decontamination procedures.

Each patient station is equipped with a sensor-field diagnostic bed with life-support enhancement shields that fold over the patient's torso to provide acoustic, ultrasonic, X-ray, and magnetic resonance imaging of the patient. A bio-mounting panel above each patient station provides round-the-clock monitoring of vital life signs and direct feed to the main medical support computer. Three-dimensional scanning and display systems are also available.

Living Quarters

Located in the central saucer deck areas are numerous living areas for Starfleet personnel. All standard living quarters offer a choice of decor to accommodate personal tastes and cultural differences. In addition to rest and living space, individual units provide independently programmable environmental control computer access and dining facilities. Units for extended families have additional space equivalent to as many as eight extra rooms.

Recreational Facilities

The *Galaxy* Class cruiser has a gymnasium, zero-gravity acrobatic room, and others sports facilities, plus numerous Holodeck and thematic rest centers.

Holodecks

A particularly attractive feature of the *Galaxy* Class cruiser is the numerous Holodeck units. Designed by a team of Federation psychologists under the direction of Simone Van Gelder, Holodeck represents a unique approach to training and recreation. Drawing on revolutionary advances in matter transformation pioneered by the Van Gelder research team, the Holodeck uses holodiodes and the ship's transporter control systems to rearrange bulk matter into a predetermined pattern. In this manner, specially constructed Holodeck environments can be altered to resemble any of several thousand locations drawn from Federation computer memory banks. Moreover, Holodeck units can use the ship's central computer to generate patterns of organic life forms, including the appearance and mannerisms of living beings. With surprising accuracy, the user can simulate encounters with life-like images of personalities, both living and deceased. Such capabilities also provide for instruction while the user trains in simulated conditions involving interaction with computer-generated personnel, friend or foe. The individual can re-create nearly perfect simulated environments, conversing with loved ones or famous individuals from any time period. Moreover, with prior programming, an individual can construct an "alternate reality" world of the imagination.

Botanical Gardens

The *Galaxy* Class cruiser has extensive botanical gardens where grow specimens of flora from across Federation space. Particularly unusual specimens are maintained in environmental enclosures simulating their native habitats.

Interactive Navigational Control System

The Interactive Navigational Control System is a highly controversial emergency system because it depends on the use of Medusan navigators. A highly intelligent race who long ago evolved into a noncorporeal form, Medusans are known throughout the Federation as mathematical and navigational experts without equal. In the last several decades, cultural and technological advances have made it possible to recruit these exotic life forms to operate as onboard navigators in direct, symbiotic relationship with the ship's artificial intelligence computer systems in case of emergency. Should normal navigational procedures

become impossible for any reason, the ship's Medusan navigator can link directly into the ship's navigational system to provide "single-handed" control of all helm and navigational system controls. Though many within the Federation question the moral implications of such a move, the onboard presence of a Medusan Specialist (who holds an honorary rank of Lieutenant Commander aboard ship) has produced no serious problems to date. Because the sight of Medusan physiology produces violent psychosis and paranoia in humanoid life forms, the Medusan must be housed in a specially prepared environment chamber that is off-limits to others.

Ship Computer System

The *Galaxy* Class's M8A Artificially Enhanced Intelligent Computer System (AICS) controls and monitors all major shipboard functions on a 24-hour basis.

The *Galaxy* Class cruiser is the first successful design in Starfleet history to incorporate a fully sentient computer system capable of individual thought. Developed by Daystrom Duotronics in conjunction with research specialists from the Federation world of Cygnus, this system, officially designated the M8 series, combines the speed and efficiency of the latest in cybernetic constructs with a biologically enhanced synaptic response system that mirrors the Human brain. Though many of the Federation's top scientists point to near-disasters involving such artificially intelligent machines in the past, supplemental programming subsystems and inhibiting priorities built into the computer's operating system have appeased fears about the potential risk to Humans. Moreover, the presence of a Betazoid as Ship's Counselor has also helped to quiet criticism of the M8. Extensive testing has shown that a Betazoid can detect even the smallest functional deviations.

Dining Facilities

Though all living quarters include food-processing units, the *Galaxy* Class cruiser also provides dining facilities for those who prefer communal meals with friends and family. In addition to mass-producing food and seating 250 at a time, these facilities have separation fields, controlled from environmental selection panels at each table. These separation fields permit a user to create a controlled environment 1.5 meters in diameter to add to his pleasure in dining. Non-humanoid races serving aboard ship for long periods are particularly grateful for this special feature. In contrast to other Starfleet vessels, the *Galaxy* Class does not separate dining facilities for officers, enlisted personnel, and civilians.

VIP Quarters

Located in the main saucer section of the ship, the VIP Quarters are special accommodations for visiting dignitaries. Individual and family suites are provided, each containing environmental control units as well as the option of altering the room's decor via matter replication units similar to the ship's Holodecks. Each suite can be secured for privacy.

Stand-by Generators

Sometimes referred to as ship's batteries, the *Enterprise's* standby power system contains six microfusion reactors linked to an emergency energizer. In addition, solar panels on the ship's hull collect and store radiation to power reactor-control equipment in an emergency. Though this stand-by power source cannot achieve warp speed, it does sustain life support and other critical ship systems.

Starfleet Naval Construction Command NCC 1701-D	
Deck Plans	
Class: Galaxy	Vessel: USS Enterprise
View: Bridge	Executed: <i>Chris Ben</i>
	Approved: <i>G.B. Park</i>
Does not reflect yard changes	

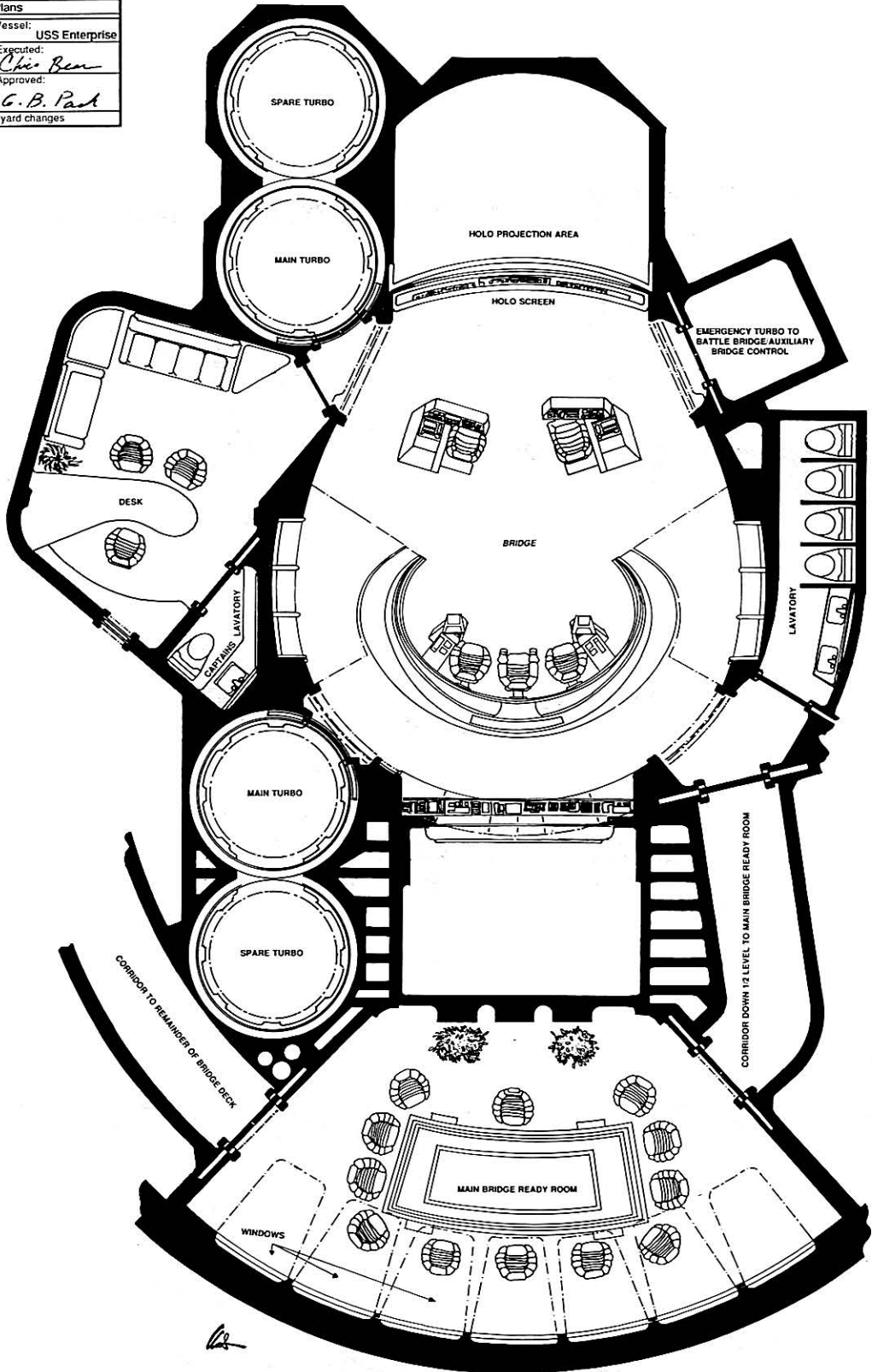

Starfleet Naval Construction Command NCC 1701-D	
Deck Plans	
Class: Galaxy	Vessel: USS Enterprise
View: Conference Room Module Type VII	Executed: <i>Chris Bann</i> Approved: <i>C. B. Park</i>
Does not reflect yard changes	

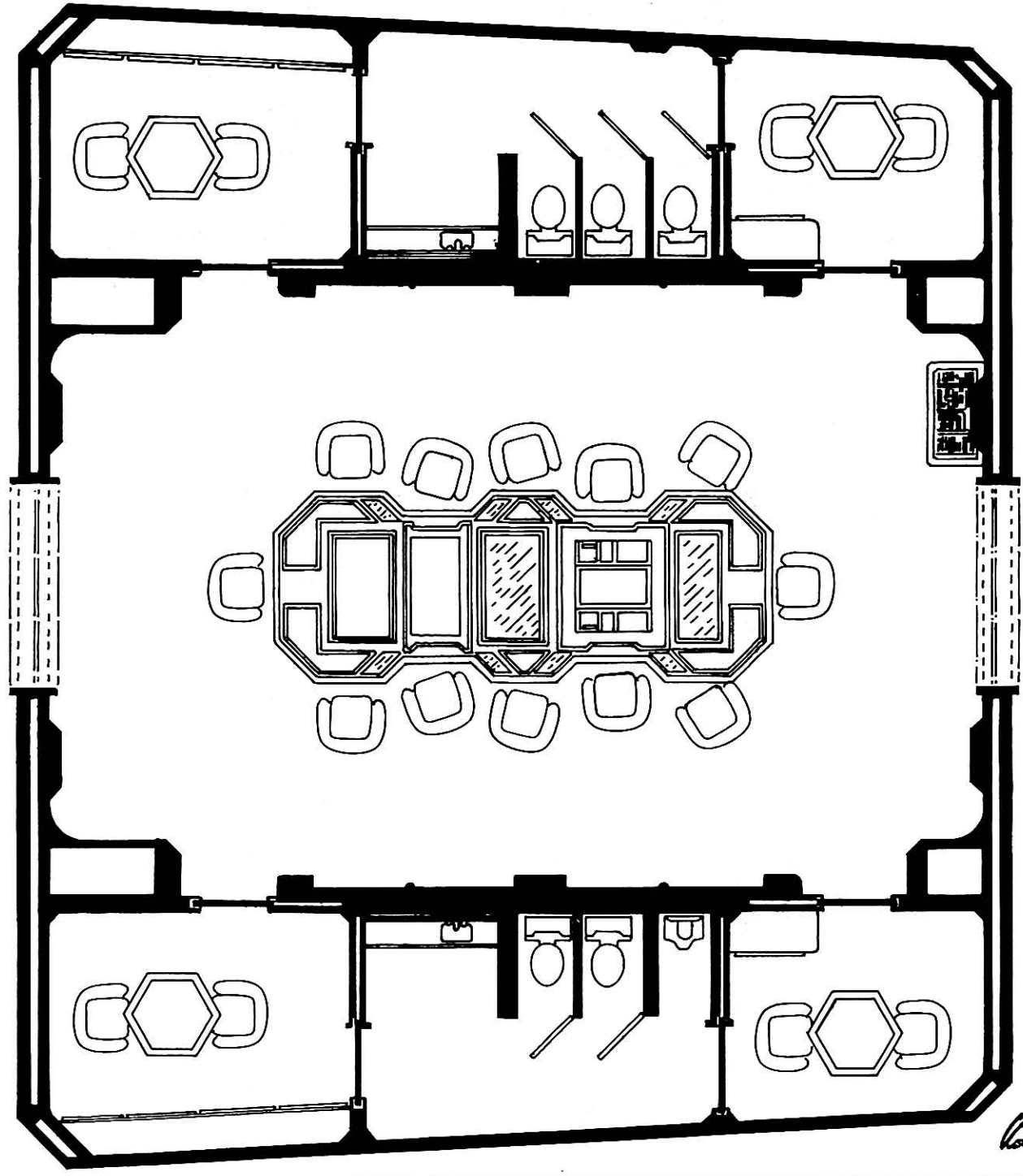

TRANSPORTER STATION

63

Starfleet Naval Construction Command NCC 1701-D	
Deck Plans	
Class: Galaxy	Vessel: USS Enterprise
View: Transporter Room	Executed: <i>Chris Bean</i> Approved: <i>G. B. Paul</i>
Does not reflect yard changes	

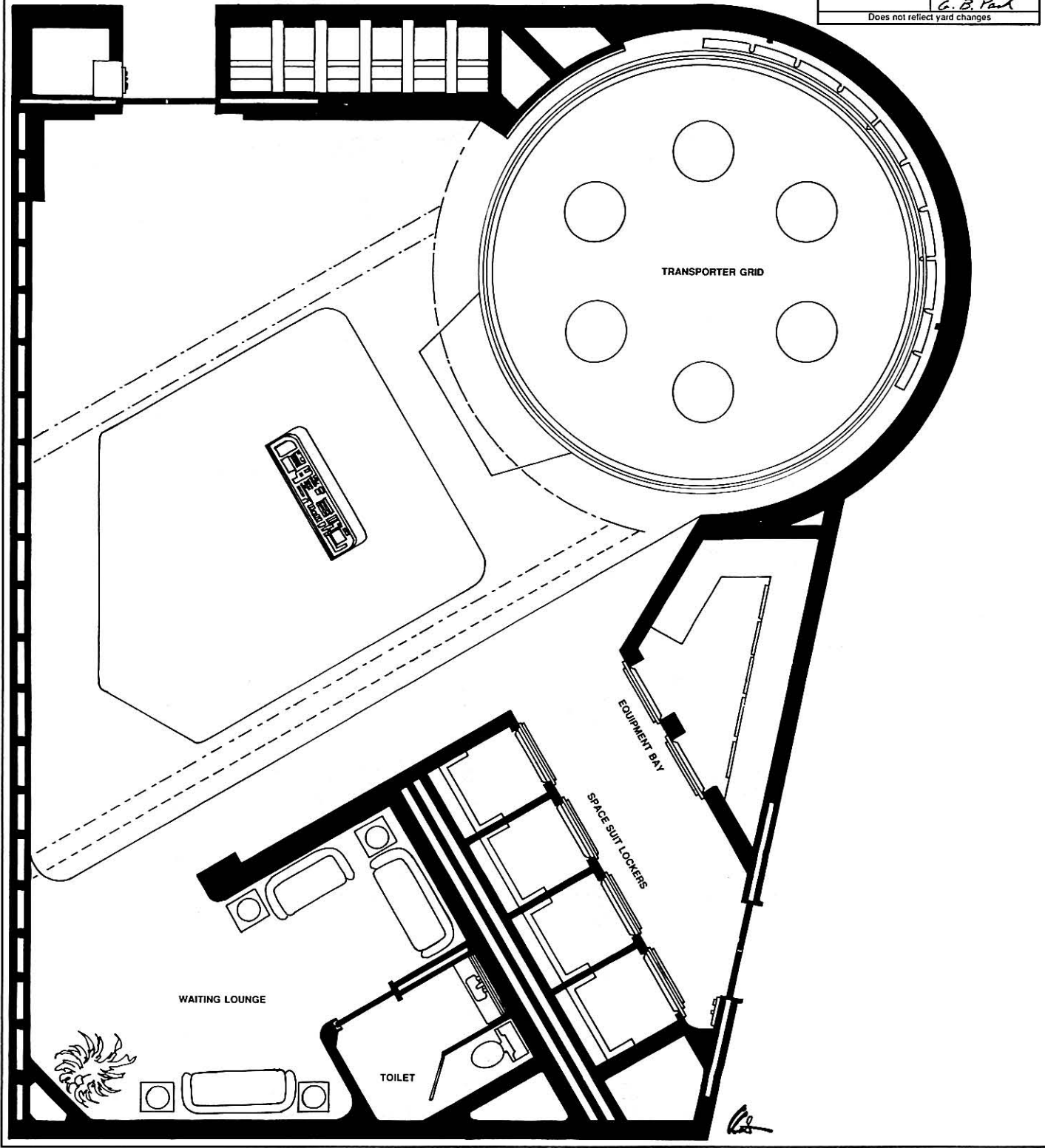

Starfleet Naval Construction Command NCC 1701-D	
Deck Plans	
Class: Galaxy	Vessel: USS Enterprise
View: Education Center Module	Executed: <i>Chris Bean</i>
	Approved: <i>G. B. Peck</i>
Does not reflect yard changes	

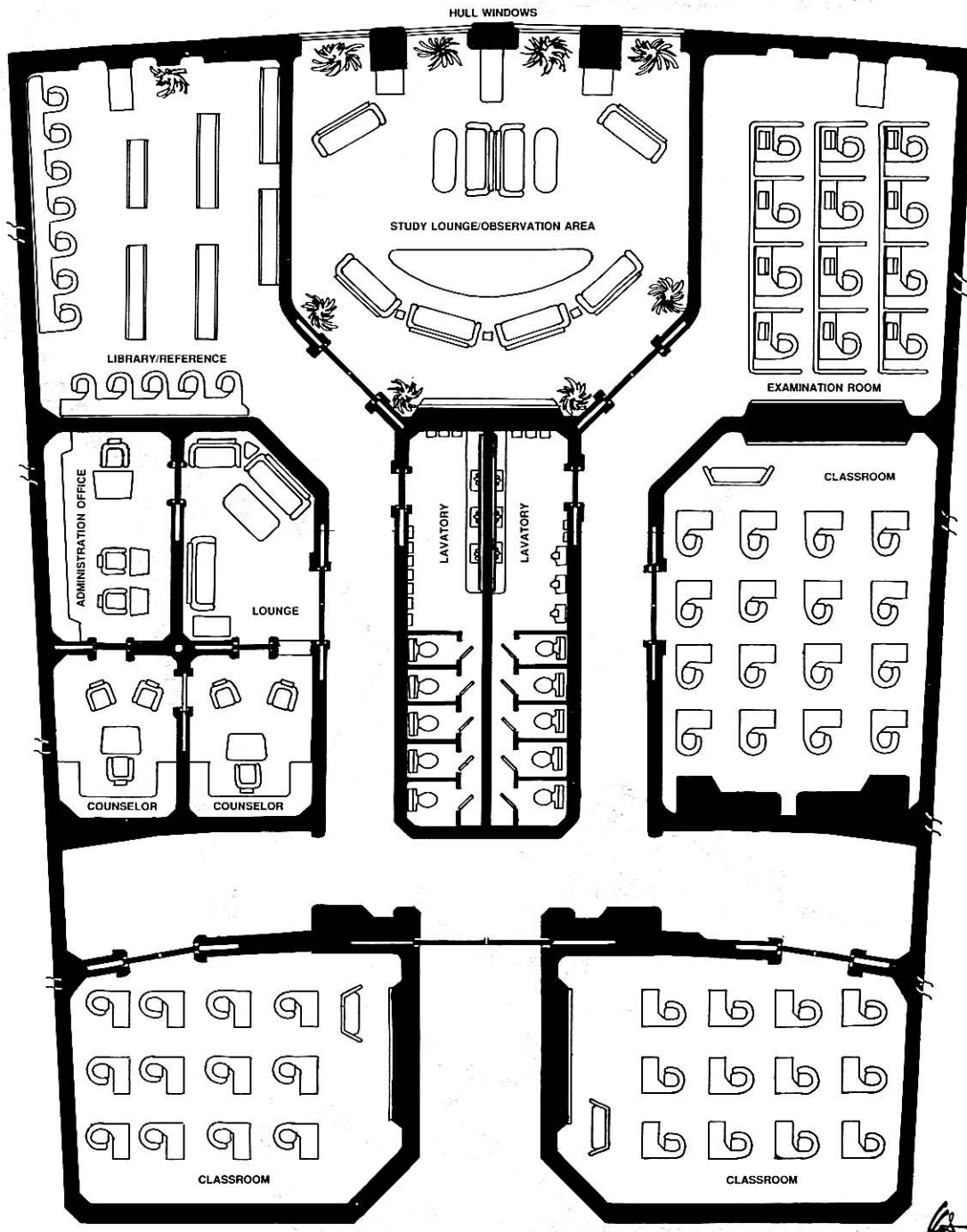

Handwritten signature or initials.

Starfleet Naval Construction Command NCC 1701-D	
Deck Plans	
Class: Galaxy	Vessel: USS Enterprise
View: Medical Center Module	Executed: <i>Chris Dem</i> Approved: <i>L. B. Park</i>
Does not reflect yard changes	

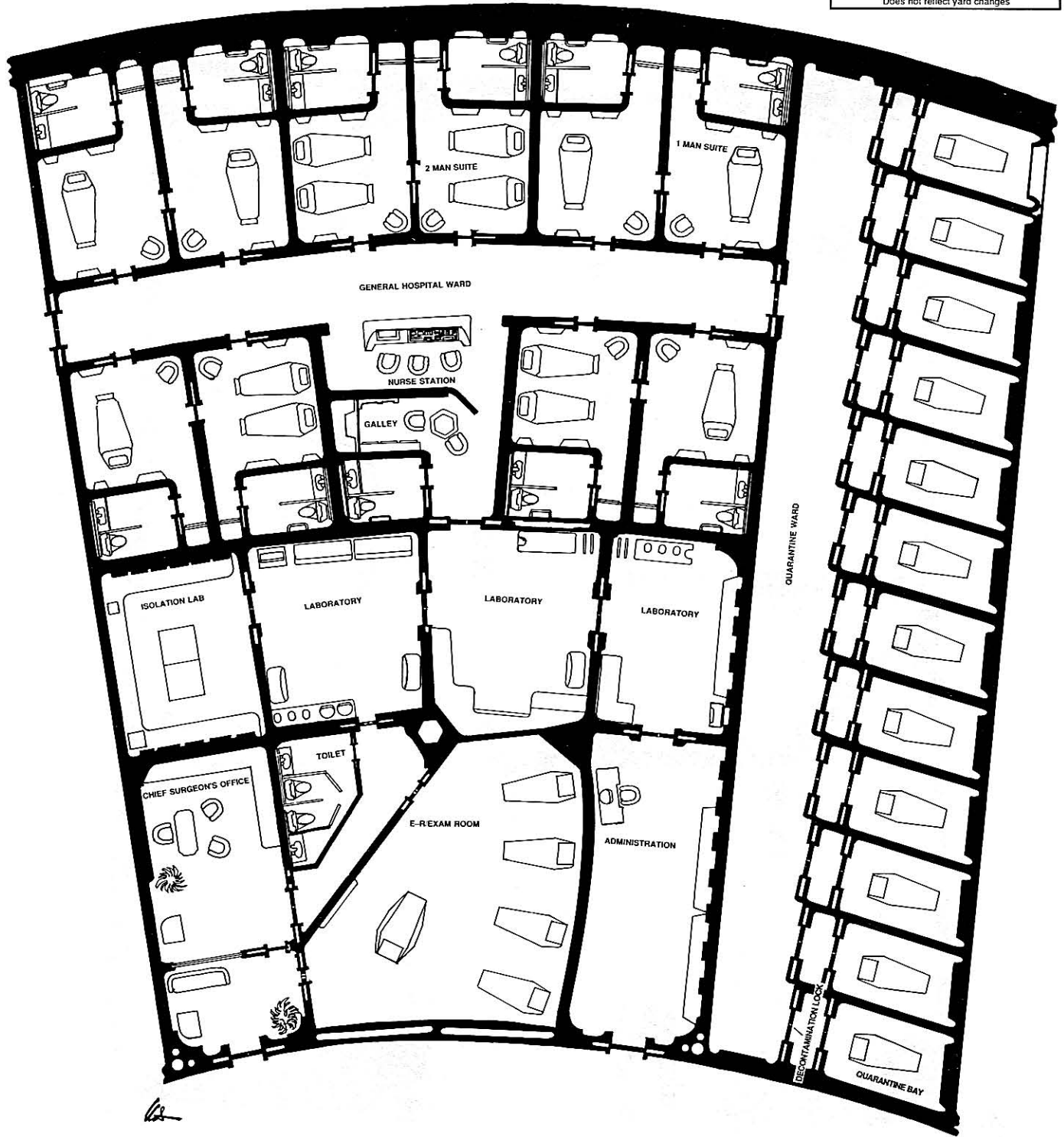

Starfleet Naval Construction Command NCC 1701-D	
Deck Plans	
Class: Galaxy	Vessel: USS Enterprise
View: Bachelor Officer's Quarters Module Type XI	Executed: <i>Chris Ben</i> Approved: <i>G. B. Paul</i>
Does not reflect yard changes	

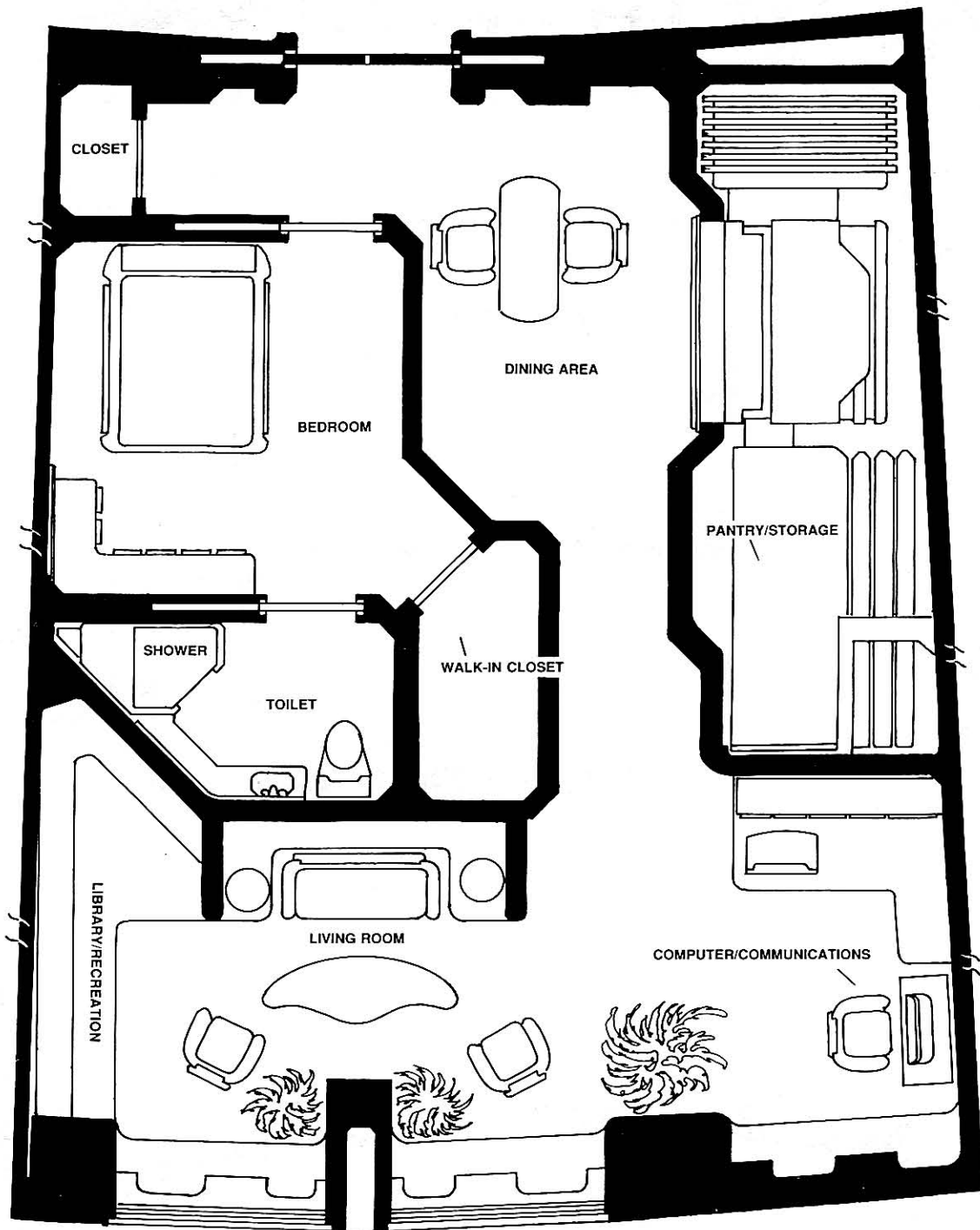

CS

CIVILIAN QUARTERS—2 PERSON

67

Starfleet Naval Construction Command NCC 1701-D	
Deck Plans	
Class: Galaxy	Vessel: USS Enterprise
View: Civilian Quarters 2 Person Unit Module Type IV	Executed: <i>Chris Bann</i> Approved: <i>G. P. Pugh</i>
Does not reflect yard changes	

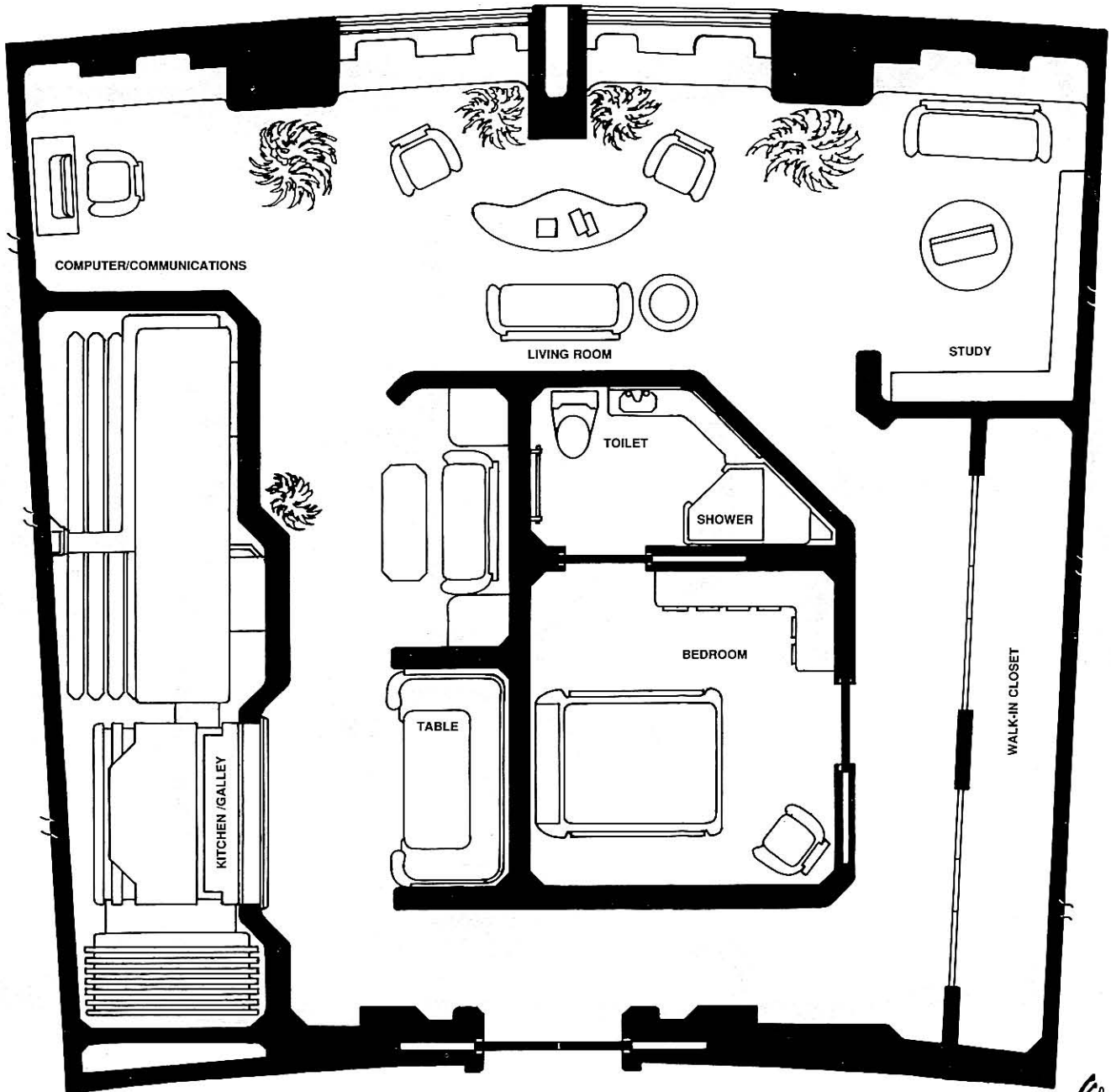

Handwritten signature

Starfleet Naval Construction Command NCC 1701-D	
Deck Plans	
Class: Galaxy	Vessel: USS Enterprise
View: Civilian Quarters Family Unit Module Type III	Executed: <i>Chris Bann</i> Approved: <i>G. D. Park</i>
Does not reflect yard changes	

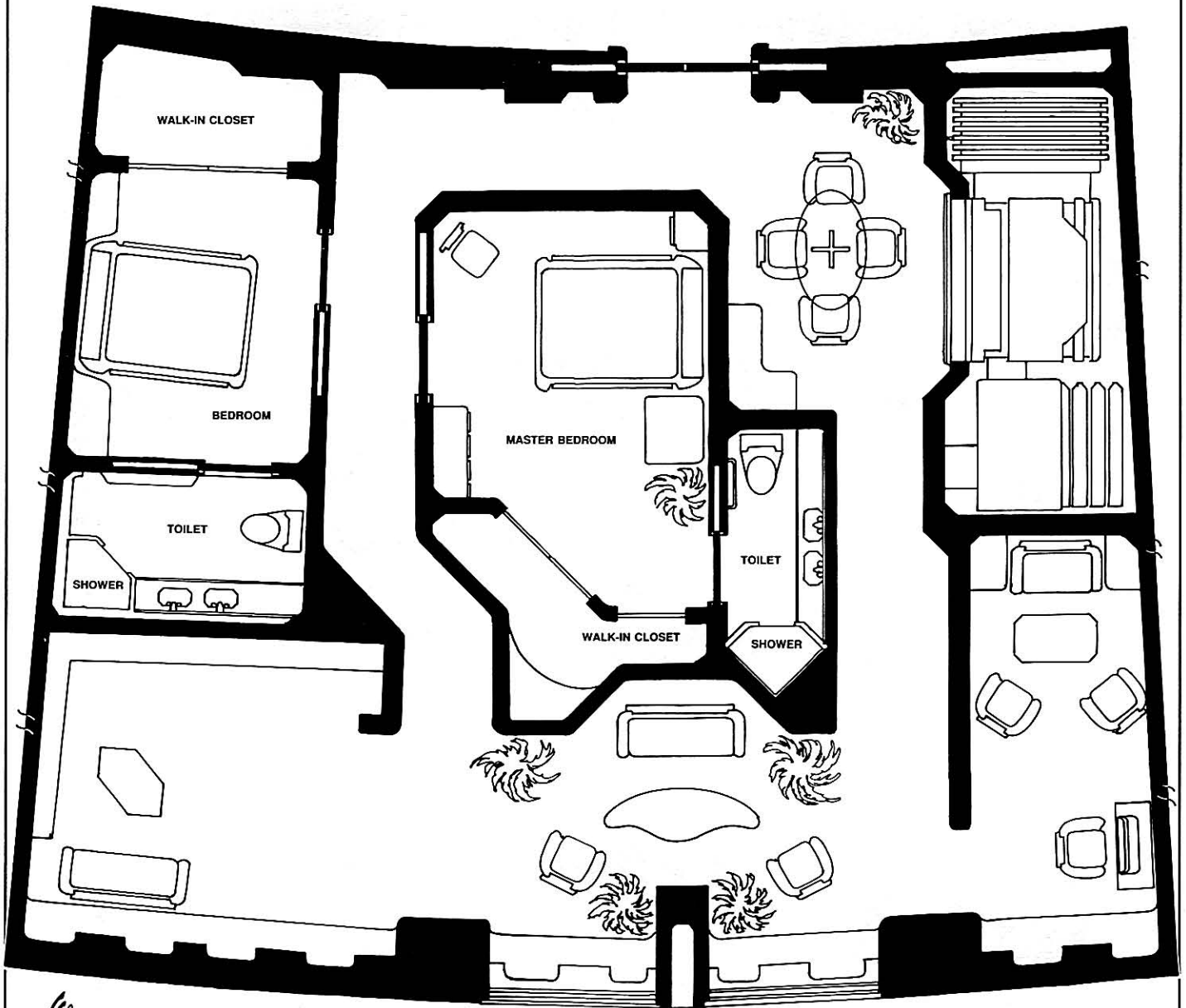

Handwritten signature

Starfleet Naval Construction Command NCC 1701-D	
Deck Plans	
Class: Galaxy	Vessel: USS Enterprise
View: Holodeck	Executed: <i>Chris Bean</i>
	Approved: <i>C. J. Smith</i>
Does not reflect yard changes	

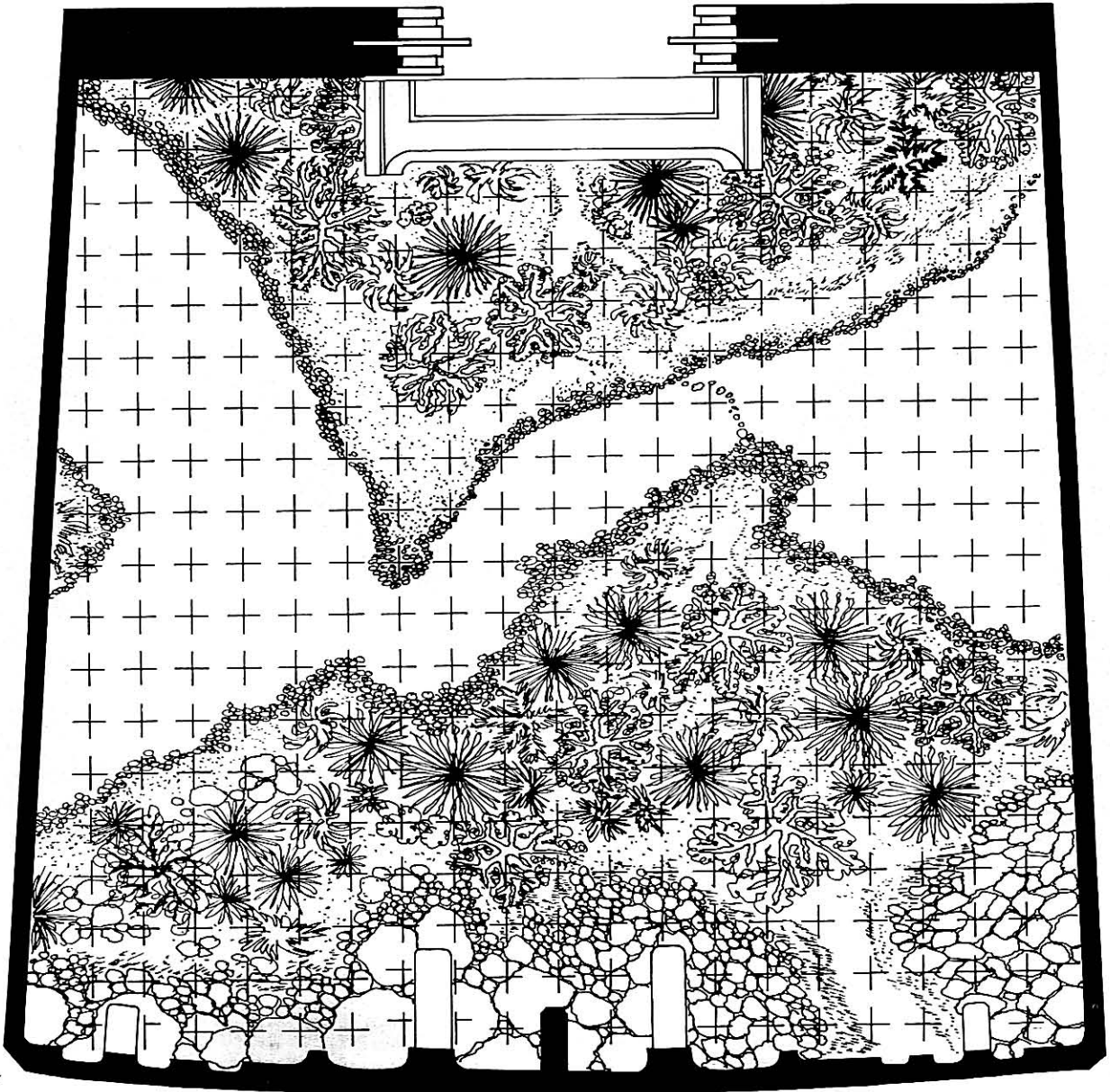

CS

Starfleet Naval Construction Command NCC 1701-D	
Deck Plans	
Class: <i>Galaxy</i>	Vessel: <i>USS Enterprise</i>
View: <i>Navigation Control Terminal Module</i>	Executed: <i>Chris Bean</i> Approved: <i>G. B. Cook</i>
Does not reflect yard changes	

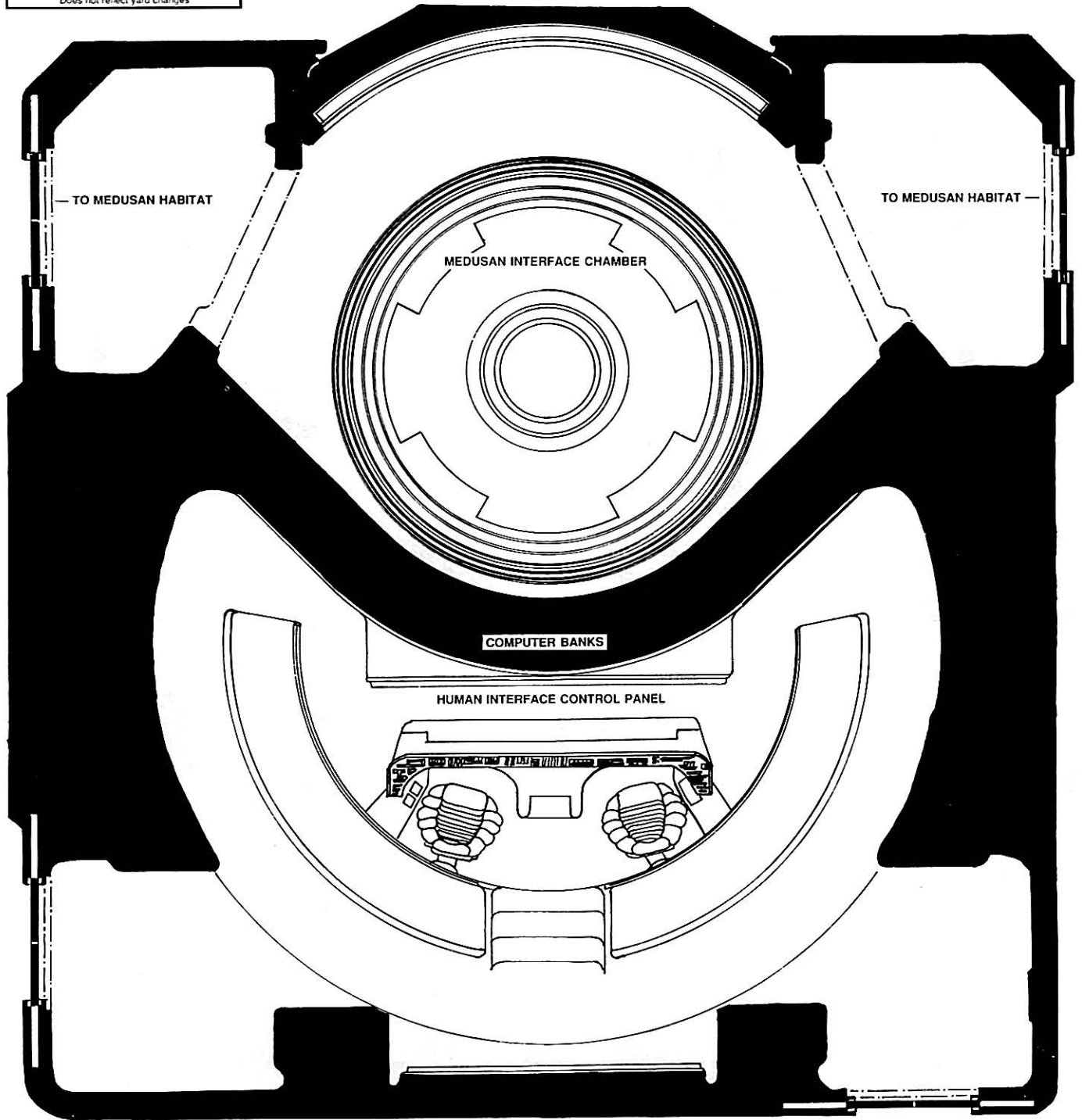

Kob

Starfleet Naval Construction Command NCC 1701-D	
Deck Plans	
Class: Galaxy	Vessel: USS Enterprise
View: Auxiliary Ship Computer	Executed: <i>Chris Ren</i> Approved: <i>G. B. B.</i>
Does not reflect yard changes	

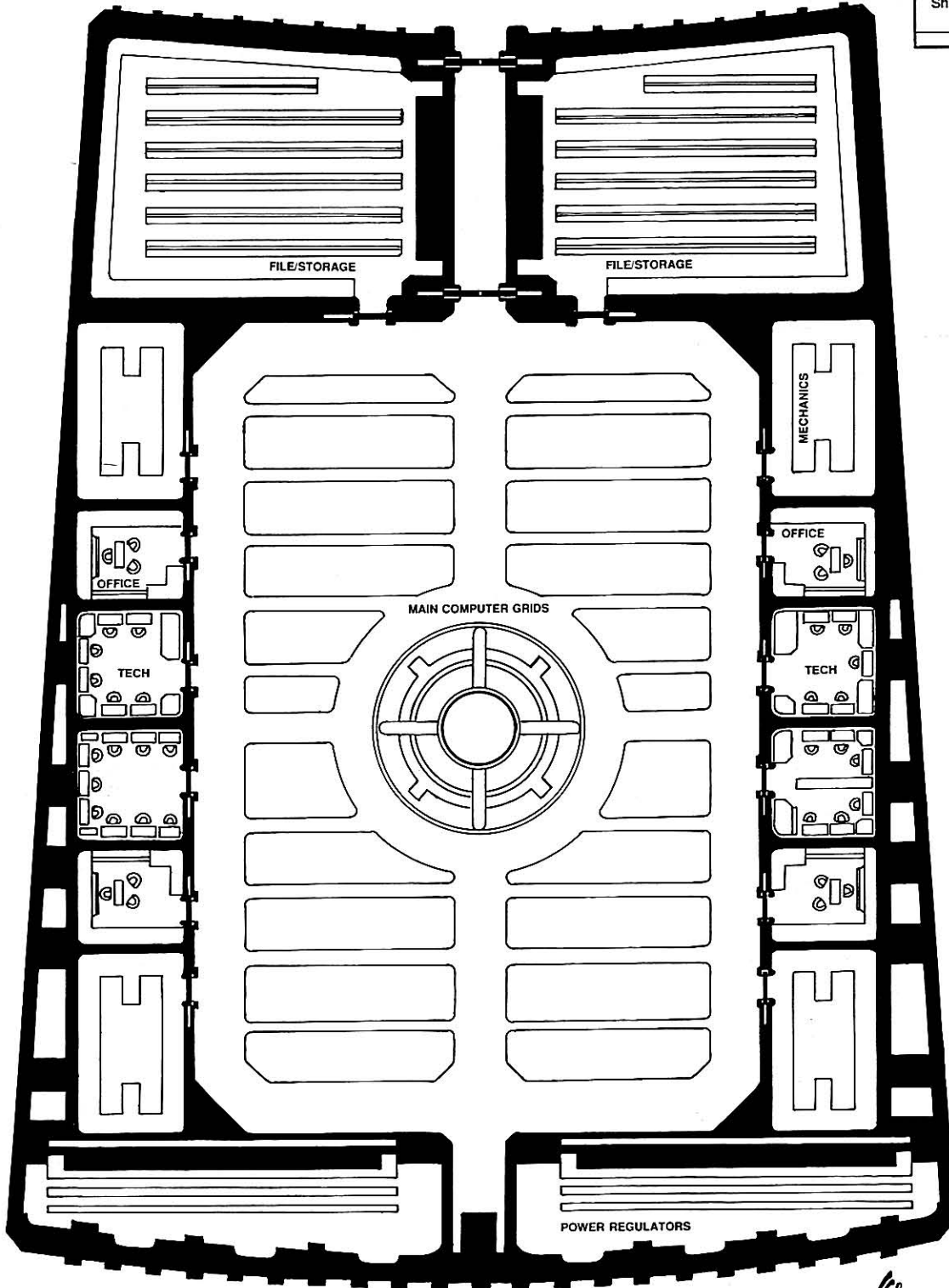

CR

STAR DRIVE SECTION

In addition to providing support for the main saucer command section, the star drive section of the *Galaxy* Class cruiser functions as an independent weapons platform. Armed with numerous phaser and photon torpedo systems and requiring only a few crew members for emergency staffing, this section can be detached to provide covering fire while the main section escapes.

Battle Bridge

The Battle Bridge can function as a duplicate main bridge to direct the engineering hull in independent flight and combat. The battle bridge has a normal complement of six crew members, but four are enough to direct operations in an emergency.

Main Engineering

The main engineering area, located in the heart of the engineering hull, houses the control center for the ship's multi-phased warp drive and impulse engine propulsion systems. Independent modular stations monitor matter and antimatter intermix temperatures, power conversion and distribution, electrical power relays, deflector and shield control systems, and life-support systems. This station is staffed by twelve engineering specialists and eight technicians.

Adjacent to the main engineering room area are banks of visual, audio, and sensory control screens for monitoring every system aboard the *Enterprise*. In the event of a system malfunction, a central diagnostic computer tied into the ship's main computer immediately notifies both the Chief Engineering Officer on duty and the Chief Security Officer's bridge status board. It also begins a diagnostic check of the malfunctioning system.

Sensory Data Control Center

This section provides for manual operation of all long-range and tactical combat command sensors and systems collecting biomedical, planetary survey, and deep-space data. This center also houses backup computer control systems capable of maintaining full sensory control in case of emergency.

Auxiliary Control—Engineering Hull

Designed for use in emergency situations of severe damage to main and secondary bridge centers or disruption of power regulation from main engineering, Auxiliary Control acts as a backup station to direct power and life-support systems.

Emergency Deflector Control

This station allows the manual control of ship's deflector and multiple defense shield systems in the event that Bridge control is lost or if a malfunction occurs in the main computer system. Two Deflector Control Specialists monitor this station at all times.

Emergency Life Support Control

Science and Engineering Specialists at this station can maintain the ship's life-support system should the ship's computer system suffer major damage.

Tractor Beam Control

Two tractor beam control points are located within the engineering hull, permitting the manual operation and direction of the ship's tractor beams in an emergency. These stations are manned only when needed.

Probe Launch Control

This station directs the launching of the *Galaxy* Class cruiser's six deep-space probes. Science Specialists at this station can monitor deep-space telemetry and data transfer from the probe, providing almost instantaneous analysis of incoming data for relay to Main Bridge Stations. This station is not normally manned.

Manufacturing and Synthesis Plant

Just as food processors alter chemical matrices to produce edibles, these manufacturing plants alter the structure of bulk matter to produce clothing, electronic components, crystalline structures, textiles, personal articles, and so on.

Hydroponics Plant

Crew members and computers in the hydroponics plant care for hundreds of varieties of plant life, including fruit and nutritious fungus. Automated computer systems continuously monitor growth, soil, chemical content, oxygen production, and other variables. If the ship's food processing units became crippled, emergency stores from the hydroponics plant could feed the entire ship's company on reduced rations for more than two months.

Microwave Power Projector

It is sometimes necessary to provide emergency power for planetary installations. The *Galaxy* Class is capable of transmitting sufficient energy to illuminate a small city through the use of microwave relay projectors, which beam energy to ground-based collectors.

Main Energizer

In addition to making high-warp speeds possible, dilithium crystals serve another critical function. A separate set of ten crystals in the housing of the main energizer regulates the flow of energy derived from the reactor and engines to all other shipboard systems. Thus, the main energizer acts as a combination "distributor cap and transformer," with constantly changing power flows to all portions of the ship. Should this system be damaged, energy settings would have to be locked into place to reduce the risk of system overload, power buildups, or runaway reactions. Backup energizers can continue to distribute power, but the main energizer must be repaired before the ship's power could be safely increased.

Security Holding Area

Though the *Galaxy* Class cruiser's mission is a peaceful one, the ship does include an area for keeping personnel and cargo under force-field detention or protection.

Armory

Located throughout the Security Holding Area are the Armories. These secure areas hold stores, weapons, and other equipment for use in an emergency. This equipment includes Mark V and Mark VI phasers, portable force-field generators, battle armor, sonic concussion grenades, and heavy-duty phaser rifles.

Observation Decks

Located at various locations throughout the ship are numerous observation decks. These provide visual and optical aids to enhance the view of space during flight and allows for examination of ground features while in orbit. Special filters block harmful radiation and solar particles.

Docking Rings

The *Galaxy* Class cruiser has two docking rings for standard shuttle pods that carry individual crew members and special cargo. Two additional retractable docking rings are available on the saucer section.

Escape Pods

In addition to shuttlecraft, the *Galaxy* Class cruiser has 446 emergency escape pods at strategic locations in the star drive and saucer command sections in case an immediate evacuation becomes necessary. Each escape pod can hold eight passengers plus emergency rations and survival gear. In addition, ten escape pods located in the main saucer section are equipped with automatic life support systems to provide for the needs of infants. Once activated, these units are programmed by the ship's navigational computers to seek out the nearest star base or Federation support installation or vessel.

Recorder Marker Buoys

In the event of an emergency where destruction of the ship seems likely, the Captain can dispatch recorder marker buoys. These buoys maneuver under their own power back along the vessel's last course, eventually arriving at a friendly base to announce the ship's plight. The six Mark XII recorder marker buoys carried aboard the *Galaxy* Class cruiser have microwarp engines similar to those used by deep-space probes. Each buoy is capable of Warp 2.5 and can survive for up to five years. Internal computer systems are programmed for evasive maneuvers immediately upon launch to evade enemy fire, then for correcting navigational bearings to return along the cruiser's last set course. These buoys also transmit communication signals on a wide range of frequencies, disrupting normal channels in an effort to draw attention to themselves. Marker recorders are capable of direct interface with any Federation starship or ground-based computer net, making possible rapid downloading of the log entries stored aboard. The Captain can order that individual recorders be dispatched, but the cruiser's AICS computer will automatically dispatch all six without direct order if the vessel is in danger of imminent destruction.

Turbolift Elevators

Turbolifts provide transportation to every part of the Enterprise. Running through vertical and horizontal pneumatic tubes that crisscross the entire ship, each turbolift is equipped with a self-contained artificial gravity generator and environmental and life-support systems capable of 72 hours of independent operation. Emergency food and water concentrates are stored beneath the deck plates. Each capsule also has a data-relay terminal, a communications monitoring device, and voice-sensitive/voice-activated control panels. A turbolift elevator can transport up to ten individuals or a maximum 900 kilograms of cargo.

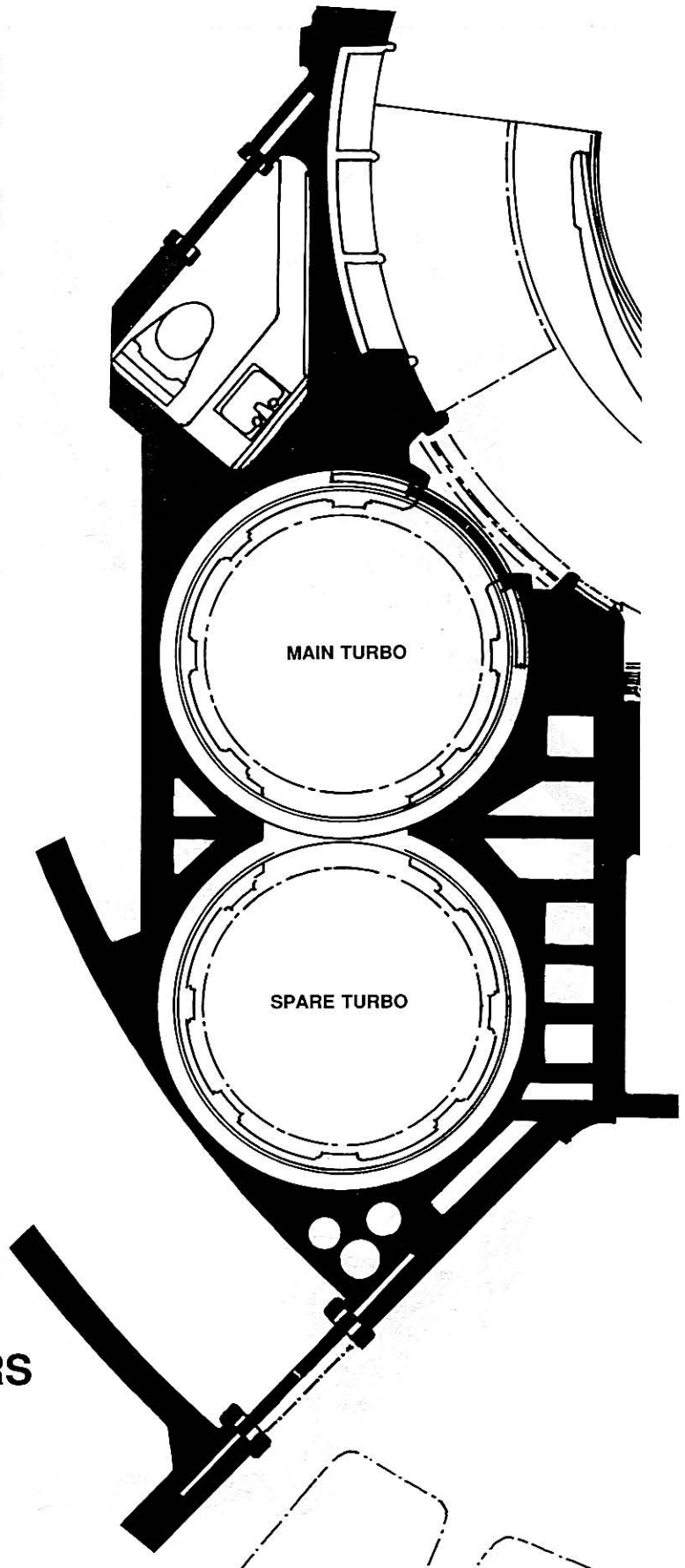
**TURBOLIFT ELEVATORS**

Starfleet Naval Construction Command NCC 1701-D	
Deck Plans	
Class: Galaxy	Vessel: USS Enterprise
View: Battle Bridge	Executed: <i>Chris Bean</i>
	Approved: <i>C. B. Ford</i>
Does not reflect yard changes	

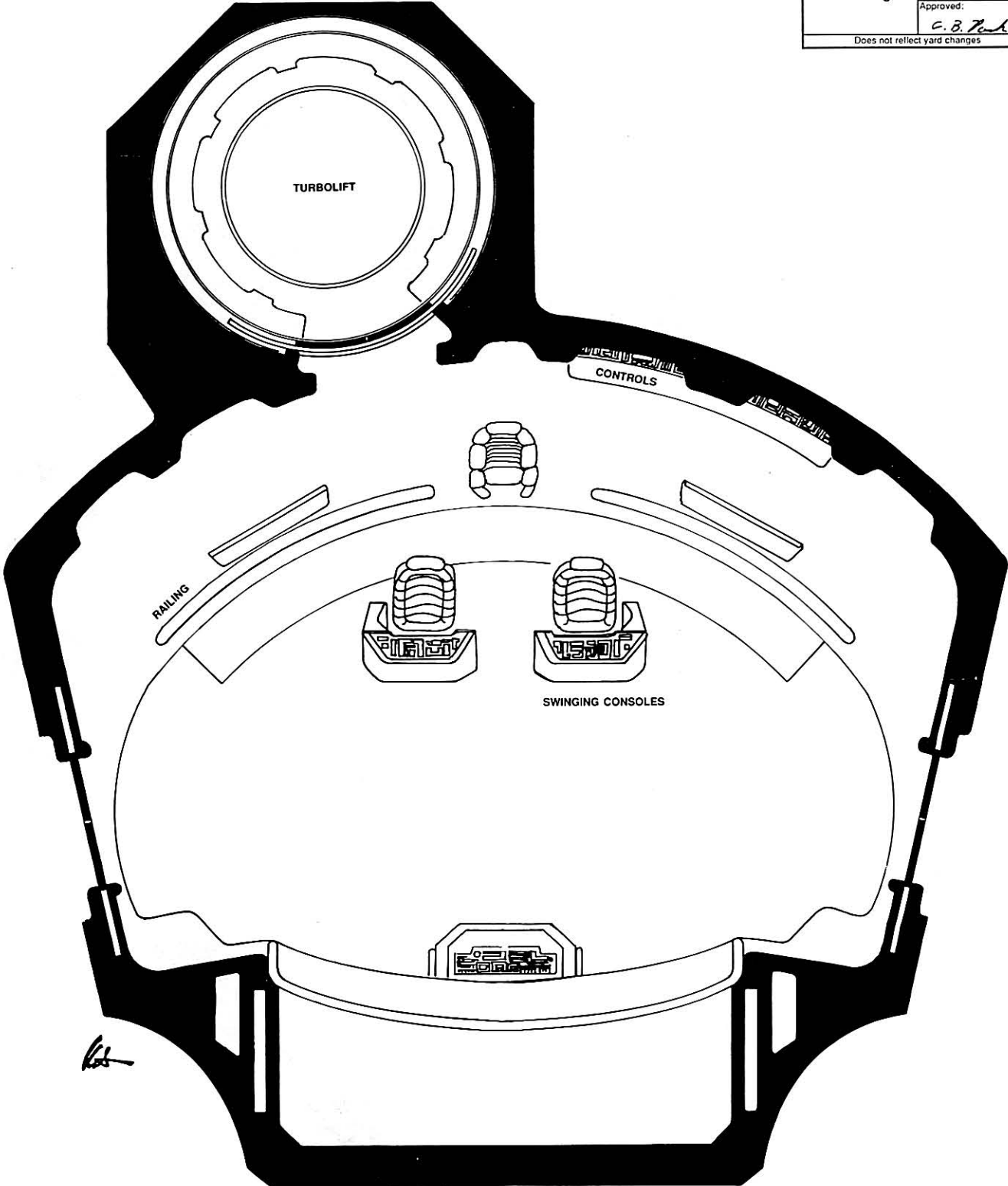

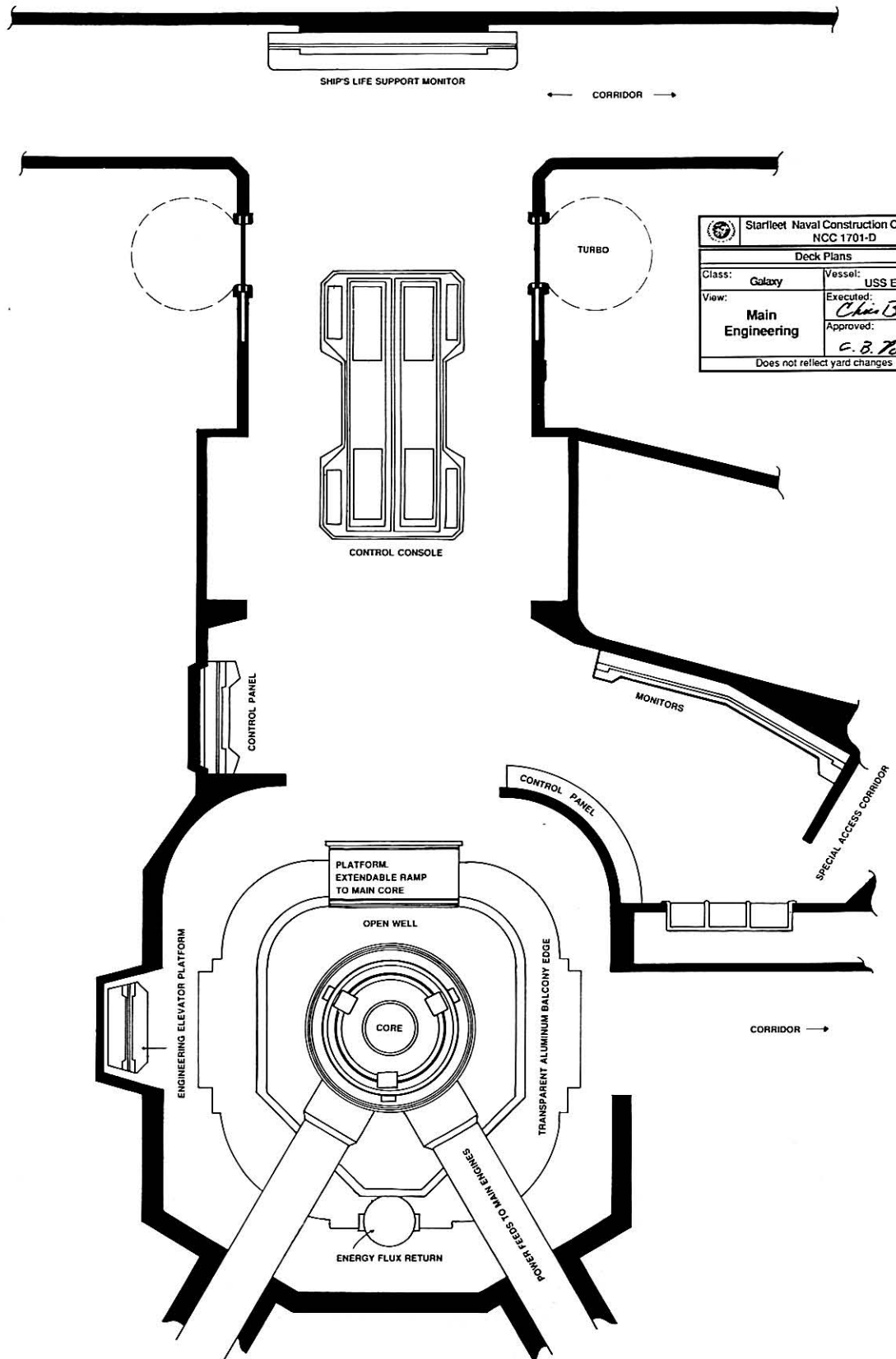

Starfleet Naval Construction Command NCC 1701-D	
Deck Plans	
Class: Galaxy	Vessel: USS Enterprise
View: Main Engineering	Executed: <i>Chris Bear</i>
	Approved: <i>C. B. Park</i>
Does not reflect yard changes	

Starfleet Naval Construction Command NCC 1701-D	
Deck Plans	
Class: Galaxy	Vessel: USS Enterprise
View: Auxiliary Bridge	Executed: <i>Chin Bean</i>
	Approved: <i>G. B. Peak</i>
Does not reflect yard changes	

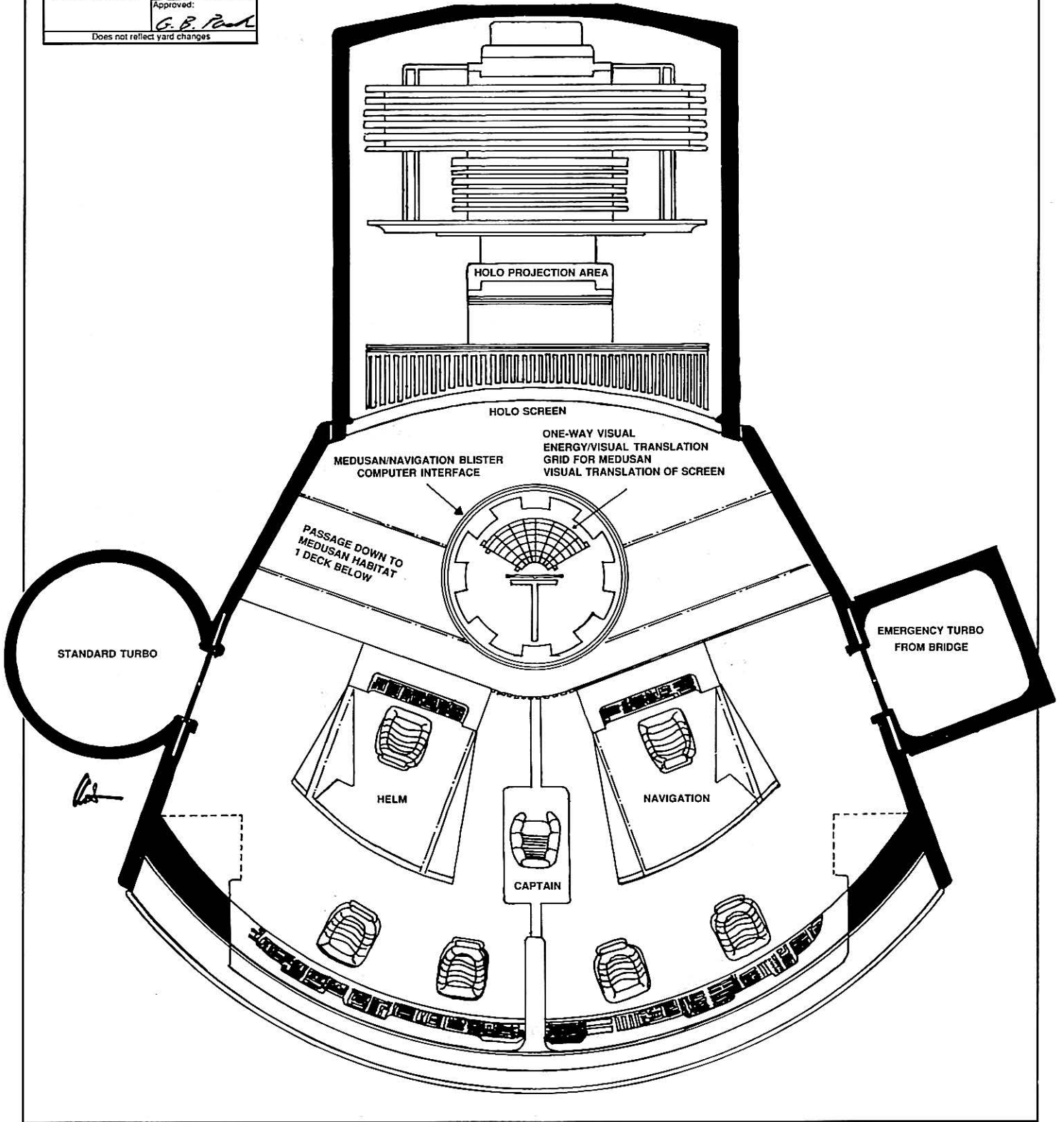

Starfleet Naval Construction Command NCC 1701-D	
Deck Plans	
Class: Galaxy	Vessel: USS Enterprise
View: Armory Module	Executed: <i>Chris Brown</i>
	Approved: <i>G. B. Pank</i>
Does not reflect yard changes	

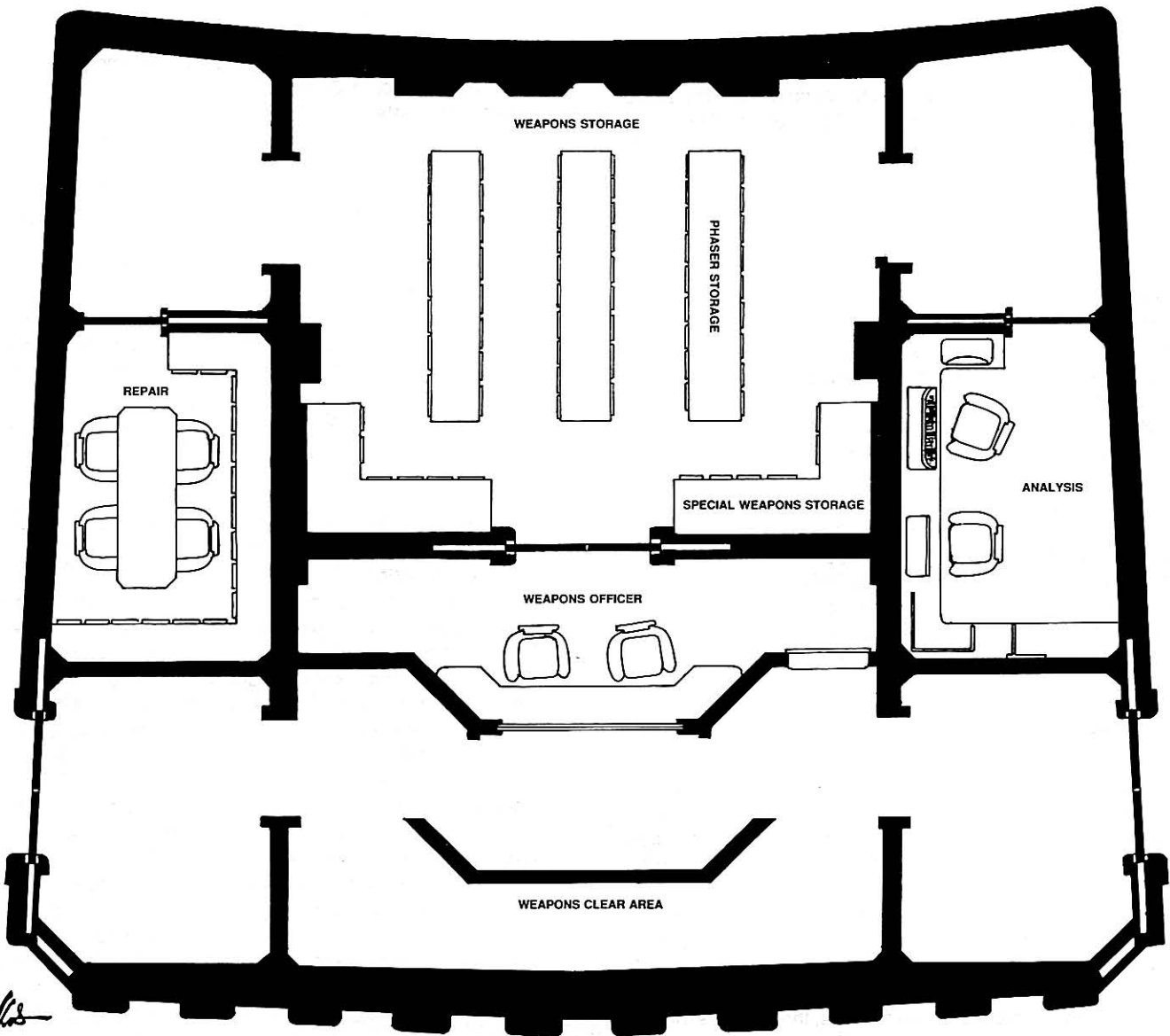

SHIP EQUIPMENT

This chapter provides an overview of the major pieces of equipment aboard newer Federation vessels.

GENERAL EQUIPMENT

Data Relay Terminals

The *Galaxy Class* cruiser provides standard data relay terminals in each crewmember's living area and at central access points throughout the vessel. The L-shaped terminals, with their multiple liquid crystal displays, replace bulkier table-top and pedestal work stations. The terminal can provide a two-way data transmission link to the ship's computer system, with another user elsewhere on the ship, or with the ship's central library. In addition, the device is capable of providing a three-dimensional holographic display of information obtained from standard data searches as well as downloading to external media sources.

Silicon Data Crystals

These wafer-thin silicon-cadmium modules are the basic data storage media for crewmembers. The modules fit into the palm of the hand and store information in millions of magnetic "bubbles" contained in a liquid crystal core. Though normally used with the ship's data relay terminals, the crystals can also be used with standard tricorder designs.

Synthetic Food Processors

In an effort to maximize space for personal accommodations, ship designers have eliminated the need for food stores aboard the *Galaxy Class*. Instead, food processing units use a variation on the traditional ship's transporter system to rearrange the molecular matrix of bulk matter into digestible and visually appealing foodstuffs.

Deep-Space Probe

The *Galaxy* carries six XS-27 deep space probes to collect and return planetary and astrophysical data far beyond the range of the ship's sensors. Mounting a specially modified miniature deflector control system, these probes can operate in "stealth" mode, relaying data without fear of detection by hostile forces. Microimpulse engines and computer-controlled navigation permit probe speeds of more than .25 the speed of light, with an extended telemetry range of three parsecs and an operational life of 18 months. These probes can be launched individually or directed at multiple targets.

Tricorders

The tricorder is a standard-issue, multi-functional device that provides environmental information to Away Team members. The tricorder acts as a sensor, collects data for review, or sets up two-way transmission with other personnel or support installations. There are three types of tricorder designs in use: the standard science tricorder, the medical tricorder, and the security tricorder.

Science Tricorder

The science tricorder gathers and transmits information on atmospheric, geological, and biological conditions on a planetary surface. This standard-issue equipment is pictured on page 80.

In the upper left is the Power Standby (**Pwr Stby**) indicator. If the tricorder is idle more than ten minutes, the system switches to low-power mode to conserve energy. This indicator shows the current power status of the unit.

F1-F2 shows the Control Function Selector. This switch allows the user to select alternate functions for standard keys.

I, E show the Sensory Controls. These keys control internal and external data readouts. The normal mode is for external sensing, but an internal setting can be selected for conducting device diagnostics.

The **Alpha, Beta, Gamma, and Delta** indicators show the user which data track is in operation.

Library A/B are external slots for library data crystals. These are stored in the back of the tricorder.

The **Display screen** is a liquid crystal screen that permits visual examination of data. This can be used in single or multi-window mode.

Device Input are the **GEO, MET, and BIO** selector buttons indicating which primary sensory arrays are activated: Geological, Meteorological, or Biological. The Geological array monitors geological activity within range of the device and can analyze ore and soil samples placed in the rear receptacle of the device. The meteorological array shows current climate conditions and forecasts weather for a 24-hour period. The final array provides detailed information on life forms within the radius of the unit.

The **Comm Trans** selector activates the tricorder's transmitting and receiving function, which allows the unit to send or receive data and visual images to and from other tricorders or shipboard computers. The first selector switch toggles between one-way reception and networking among a group of devices used by an Away Team. The second toggles between ship-and-individual tricorder links.

The **Emrg** switch is an emergency selector switch for transmitting all data from the tricorder's memory crystals to shipboard computers, and channels further sensory readings to the ship until the switch is turned off.

The **Image Record** selector records visual images and plays them back in one of four modes of operation: forward, reverse, input, and erase.

Library B is an image storage area.

The **ID touchpad** provides the option of creating automatic power-up settings and other functions as desired.

Medical Tricorder

Medical tricorders (pictured on page 81) function like standard tricorders to provide readouts on life forms within an area, but they also provide diagnostic tools to help determine the physical state of crew members or other subjects. Among this device's capabilities are magnetic brain-wave detection and analysis. A hand-held probe is equipped with ultrasonic imaging sensors that can provide detailed displays of internal organs and neurological systems. Vital life-sign sensors provide readouts of heartbeat, respiration, blood pressure, and other indicators. Stimulus monitors show the level of pain an individual may be experiencing. In addition to sensing and recording this data for analysis, the medical tricorder provides automatic communication links with the ship's diagnostic computers to help determine the type of treatment required. The medical tricorder also has receptacles for the analysis of blood and tissue samples and for the analysis of toxins that may be present in the patient's system.

DEEP-SPACE PROBE

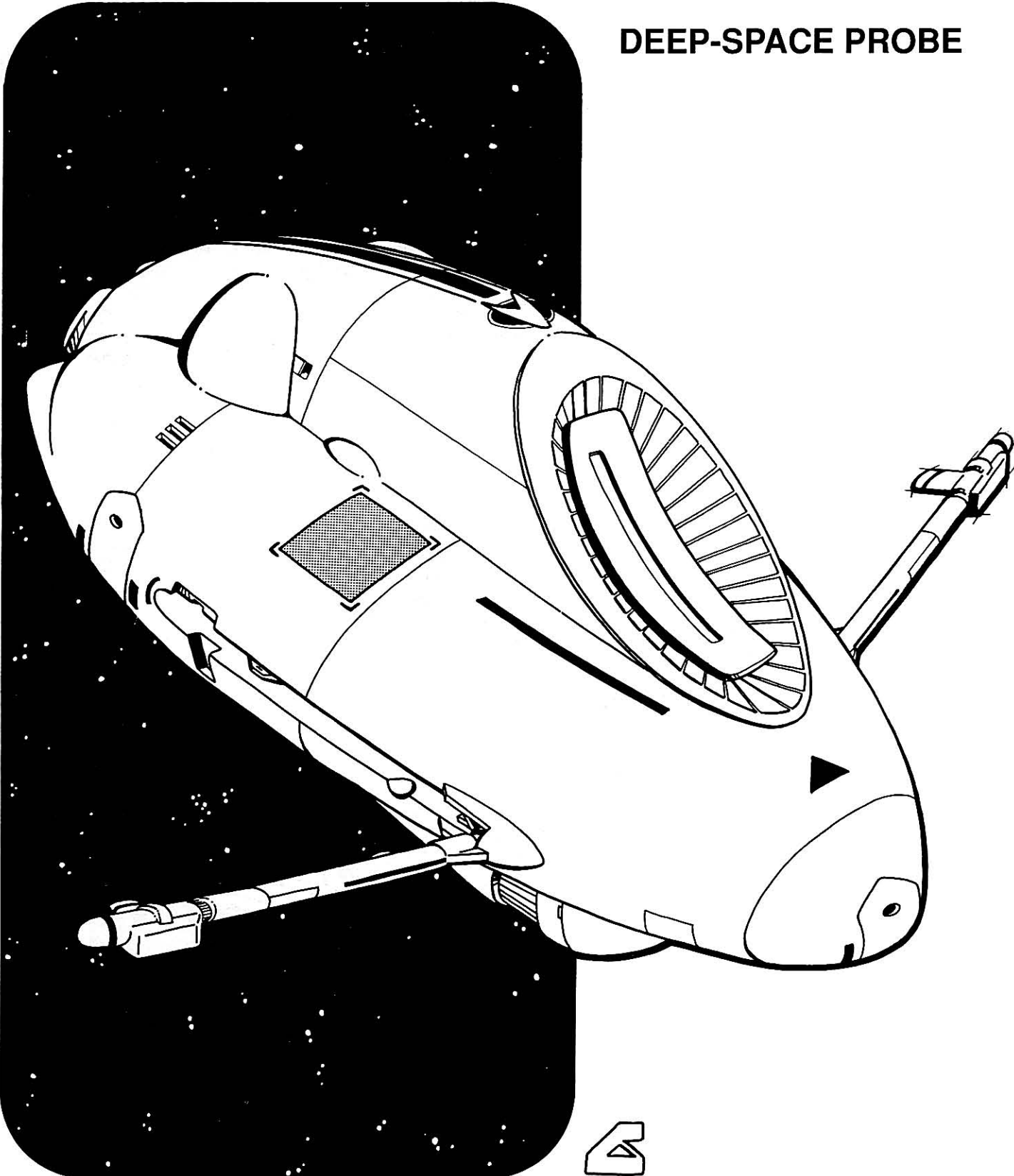

SCIENCE TRICORDER

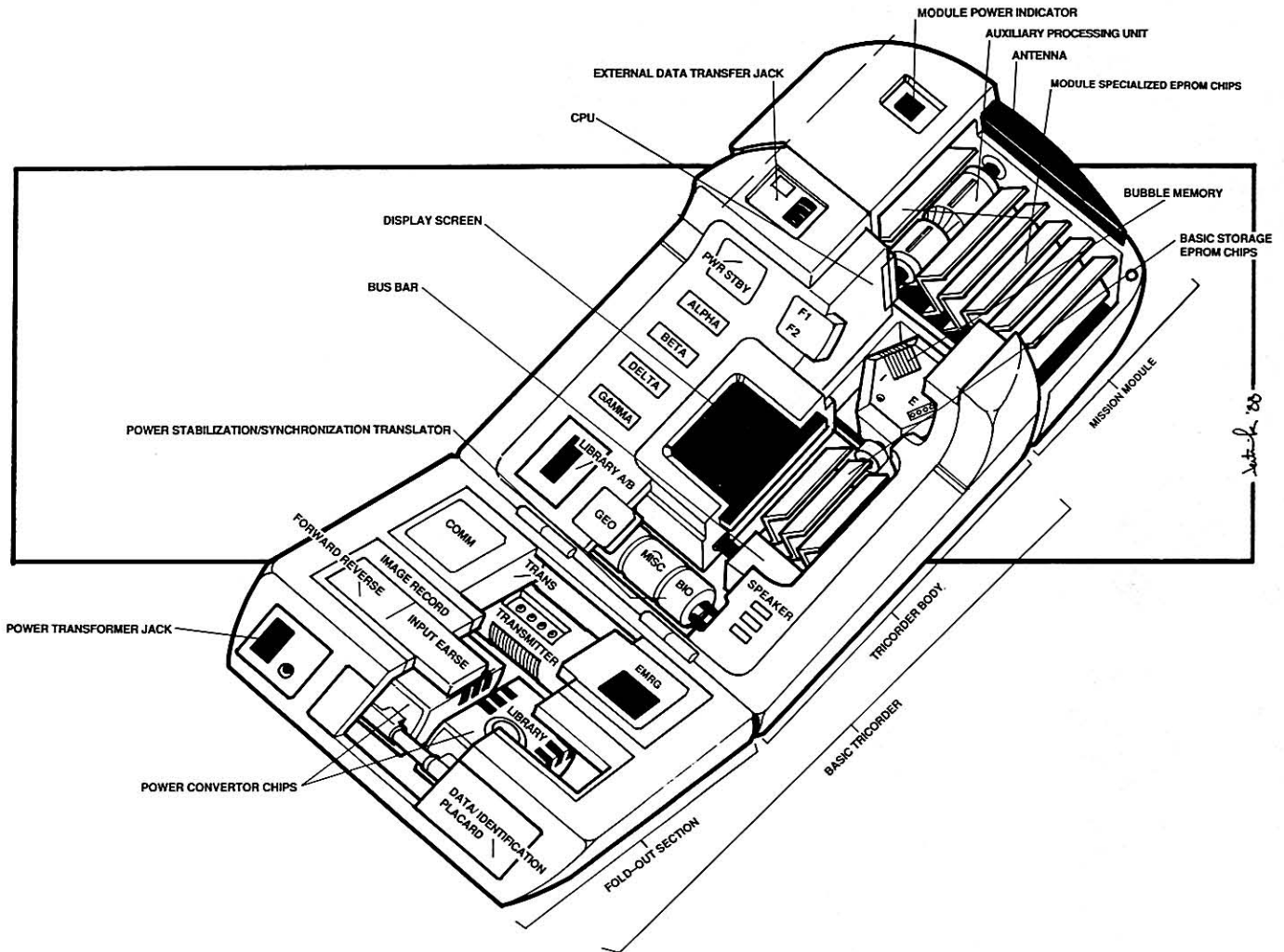

MEDICAL TRICORDER

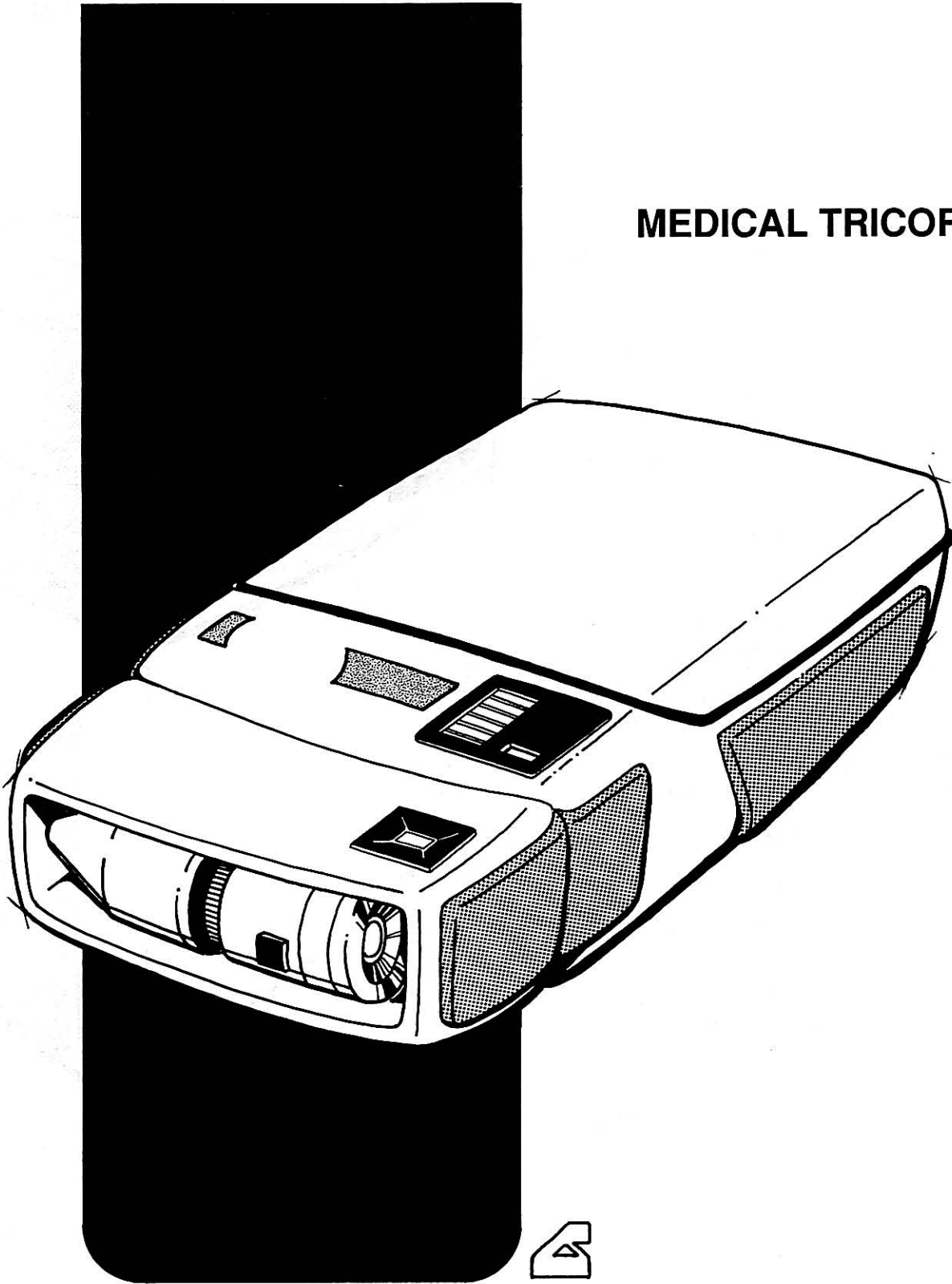

Security Tricorder

Though similar in design to the standard tricorder, the security tricorder has several specialized functions. Default settings probe within a given radius for energy and power readings consistent with weapon systems in use by hundreds of civilizations. Data in the security tricorder's crystal banks identifies the nature of a weapon by analyzing these energy transmissions. The device performs similar analysis of defensive screen systems, and uses special motion sensors to track the movement of life forms.

Biocommunicators

Shaped like the traditional Starfleet arrowhead emblem, biocommunicators are worn by all crew members while on duty. This device provides the user with instantaneous communication, via the ship's computer system, with any other member of the ship's crew. Touching the circular plate that forms the face of the arrowhead emblem alerts the ship's computer of a request for communication. The computer activates localized sensors throughout the vessel for voice analysis, identifying the reception point from speech patterns, and instantaneously opens a communications link. If the user is not included in the ship's monitoring net, palm activation of the communicator allows the computer to analyze incoming microwave transmissions that break down voice patterns to identify the reception point.

The biocommunicator also provides the ship's computer with continuous readouts of the wearer's vital signs. Biosensors housed in the emblem transmit readings that pinpoint the location of crewmembers at all times. Because the same computer controls the ship's transponder system, this "biological lock-on" can save precious seconds in locating and beaming an individual to a reception point aboard ship. Similarly, if life-sign readings indicate a problem, the main computer system alerts the ship's medical computers and notifies the Chief Medical Officer and Bridge Duty Officer.

Data Boards and Electronic Stylus

The data board is used to record information away from data relay terminals. The user writes information directly into computer files with a stylus, while a laser-guided character reader translates below the surface of the data board assembly. Conversely, computer links between data boards can draw information from the ship's memory banks, and display it on a liquid crystal image enhancer. In those situations, an electronic stylus similar to an old-style "light pen" can be used to make selections from computer displays.

Holographic Projector

In addition to small holo projectors incorporated into data relay terminals, each *Galaxy Class* ship features a wall-mounted holographic projection system in each crew quarter. These units can generate life-size, three-dimensional images of people and places drawn either from the files of the ship's computer banks of recreational media or from images that the user creates free-hand with electronic styli and data-board graphics.

SECURITY TRICORDER

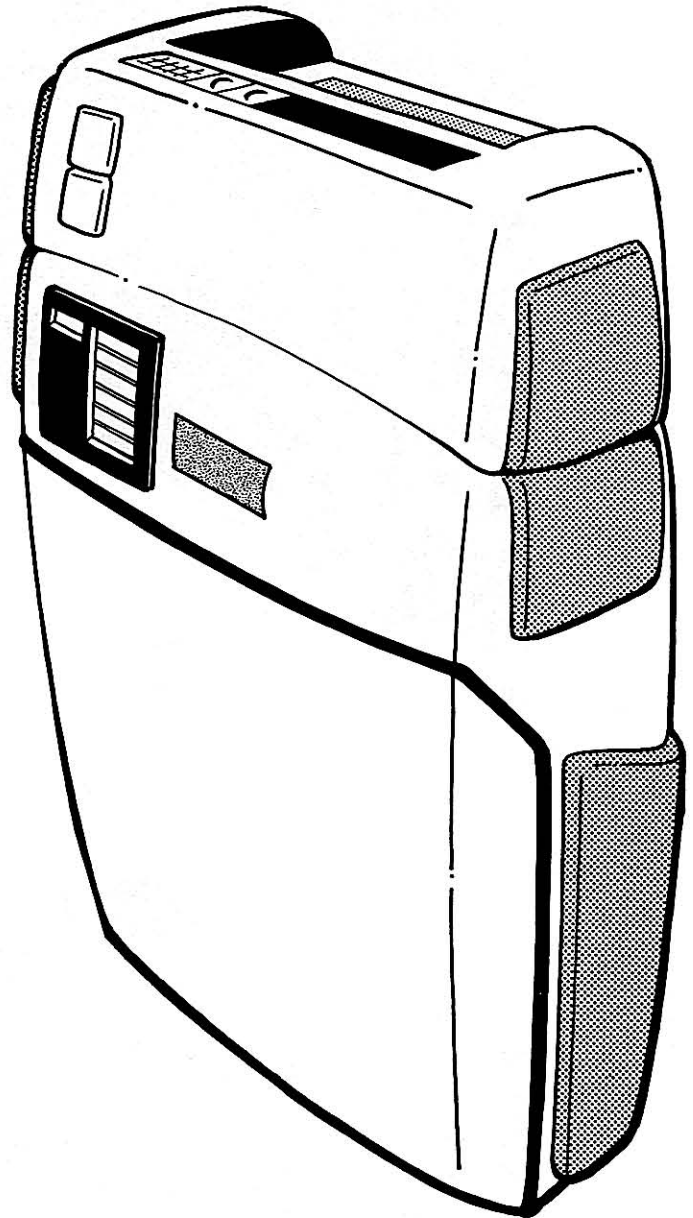

POSITION FINDER

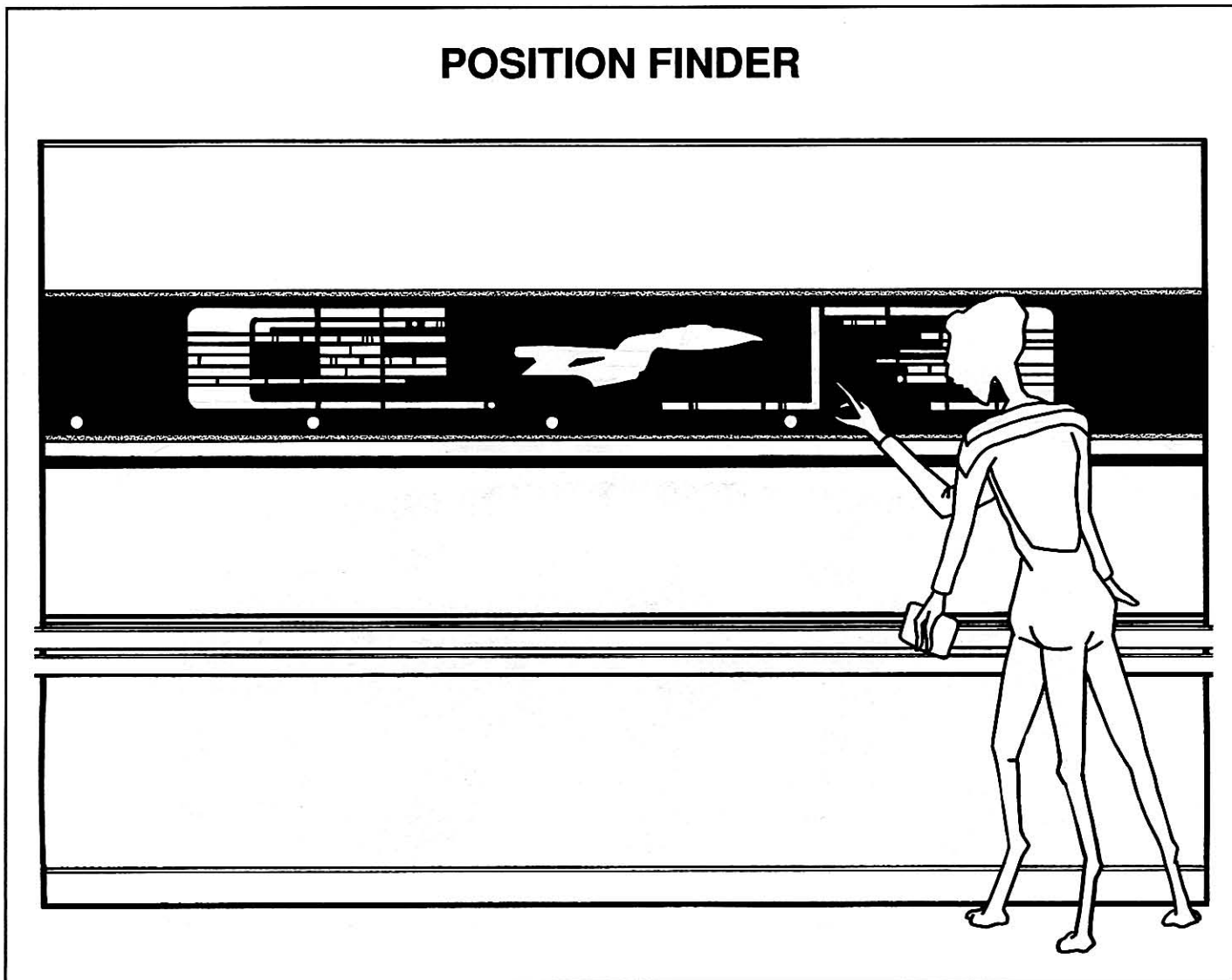

Position Finders

Given the size and complexity of the *Galaxy* Class cruiser, even experienced crew members can sometimes get lost. For this reason, there are numerous touch-activated Position Finders throughout the ship. Upon verbal request, the Position Locator will show the individual's position on a projection of the ship's deck schematic and will direct him to his destination. A scanning unit monitors the person's progress, offering instructions if he makes a wrong turn. The Position Finder will also identify the location of any other crew member currently on duty.

Control Panel Stations

One of the more visible indicators of modernization on the *Galaxy* Class cruiser is the design of control stations. Designers gave extra consideration to user comfort, providing cushioned

chairs, padded rests, and swing-out functions to allow freedom of movement. Sleek and sophisticated in appearance, these stations use touch-sensitive selectors in place of hazardous switches and toggles. To select a function, the individual places a finger over a "button" containing numerous light-sensitive diodes. Covering a sufficient number of these diodes with the outline of a finger engages that button function. Liquid crystal displays monitor activities and provide data readouts directly to the station without need of table-top monitors. In keeping with revisions in Starfleet training programs that emphasize cross-training and cross-specialization, many control stations (especially those on the bridge) have duplicate panels so that one station operator can take over the functions of a fellow crew member without moving to another station.

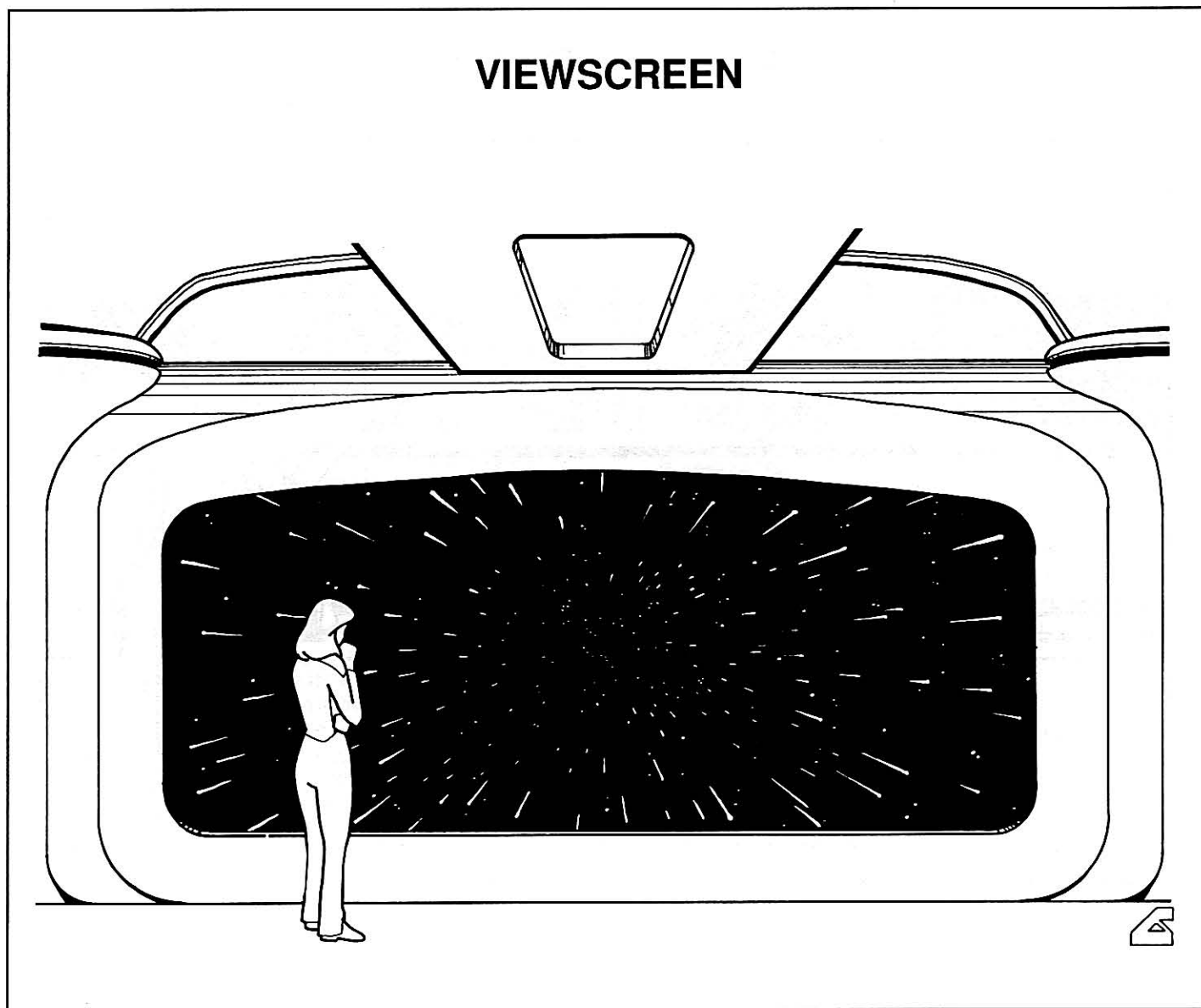

View Screens

The ship's main view screen is located on the Bridge. There are additional screens on the Battle Bridge and in Engineering, with smaller units placed throughout the ship for use by off-duty personnel. Not merely windows providing a view of space, the ship's view screens are computer-controlled and enhanced dis-

play systems that compensate for warp-speed distortions, filter out harmful radiation, alter colors to permit examination of objects not visible in ordinary light, and magnify up to 300 times. The Bridge system also includes a "heads-up" tactical display superimposed over the main visual display.

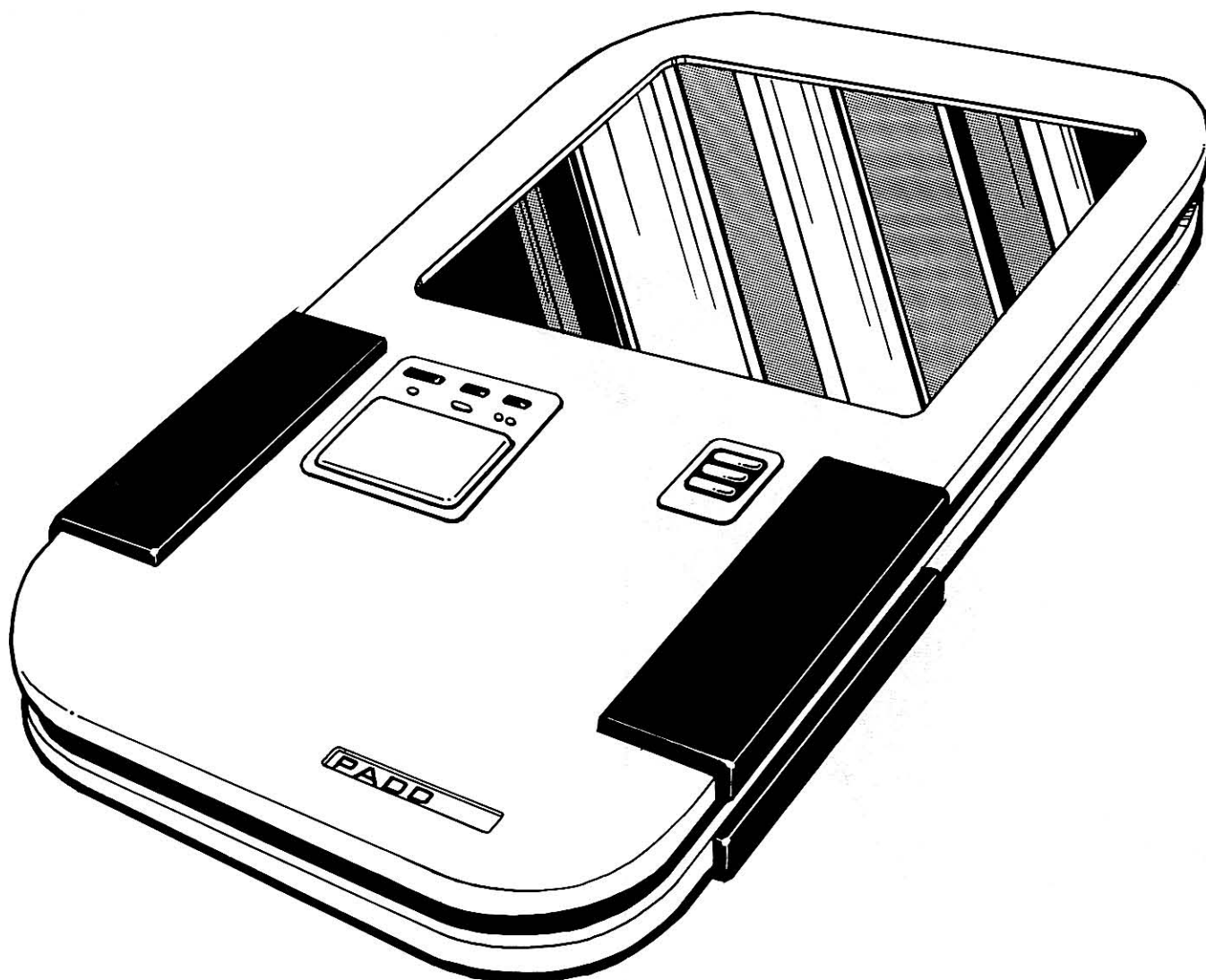
PORTABLE AUXILIARY DATA DISPLAY (PADD)**Portable Auxiliary Data Display (PADD)**

PADD is a portable version of the standard ship data board. It is for use by Away Team members who require a link with non-ship computer systems at a ground-installation or other "foreign" computer system. Random search combinations are built into the PADD device, should security passwords or system codes be required for access. Each PADD unit also contains an automatic transponder that the ship's transporter and communications control systems monitor so that the command vessel can locate the PADD user in case his biocommunicator malfunctions.

MEDICAL EQUIPMENT

Duralyne Hypo Spray

This hypo device directs compressed ultrasonic waves against a specific area of the patient's body for the high-pressure, painless insertion of medicine directly through the skin layers into the bloodstream. Made of lightweight duralynium, with an aluminum compression core atop the four-centimeter-long compound tube, this hypo spray can insert up to 200 cc's of chemical agent into the bloodstream in less than 2.5 seconds.

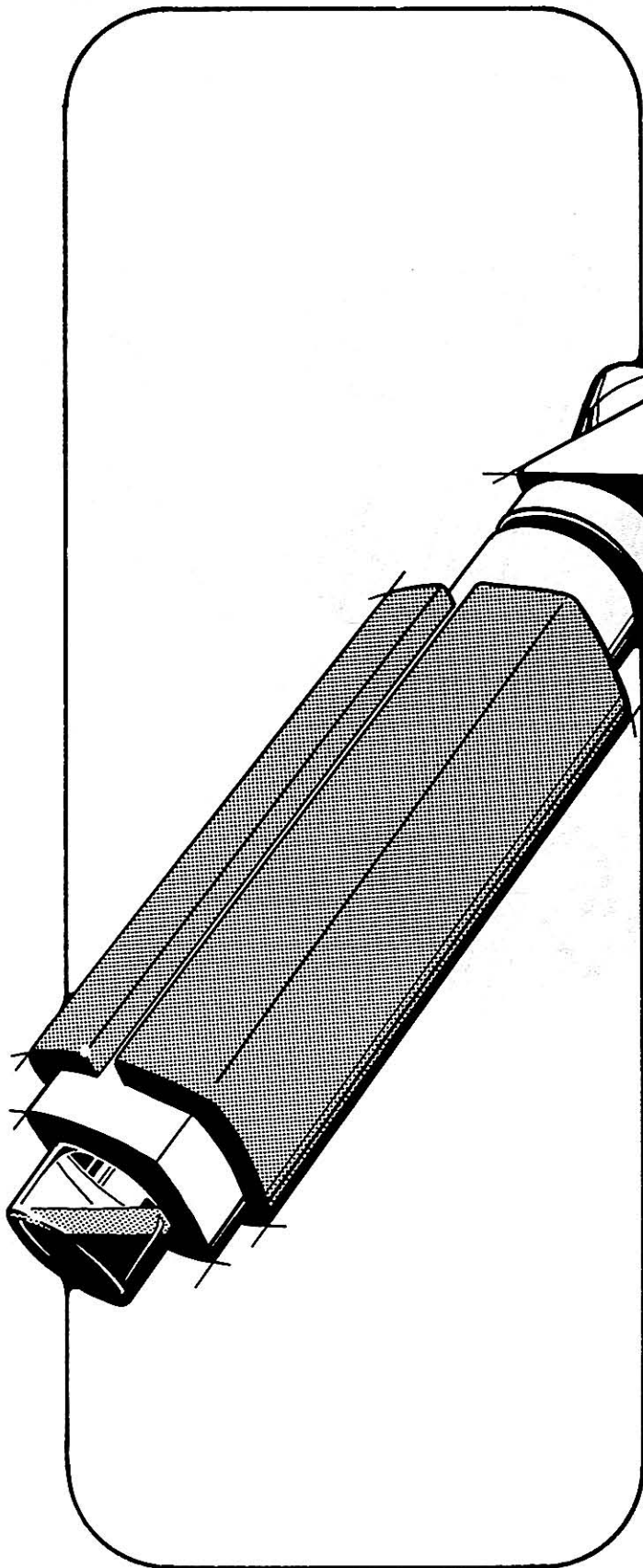

DURALYNE HYPO SPRAY

Diagnostic Wand

The Diagnostic Wand is a slender, hand-held sensor that connects to a medical tricorder. As the device is passed over a patient's body, its array of diagnostic sensors make a thermal scan. Several complete passes present a detailed description of the patient's medical status, with recommended treatment shown on the tricorder's main display viewer.

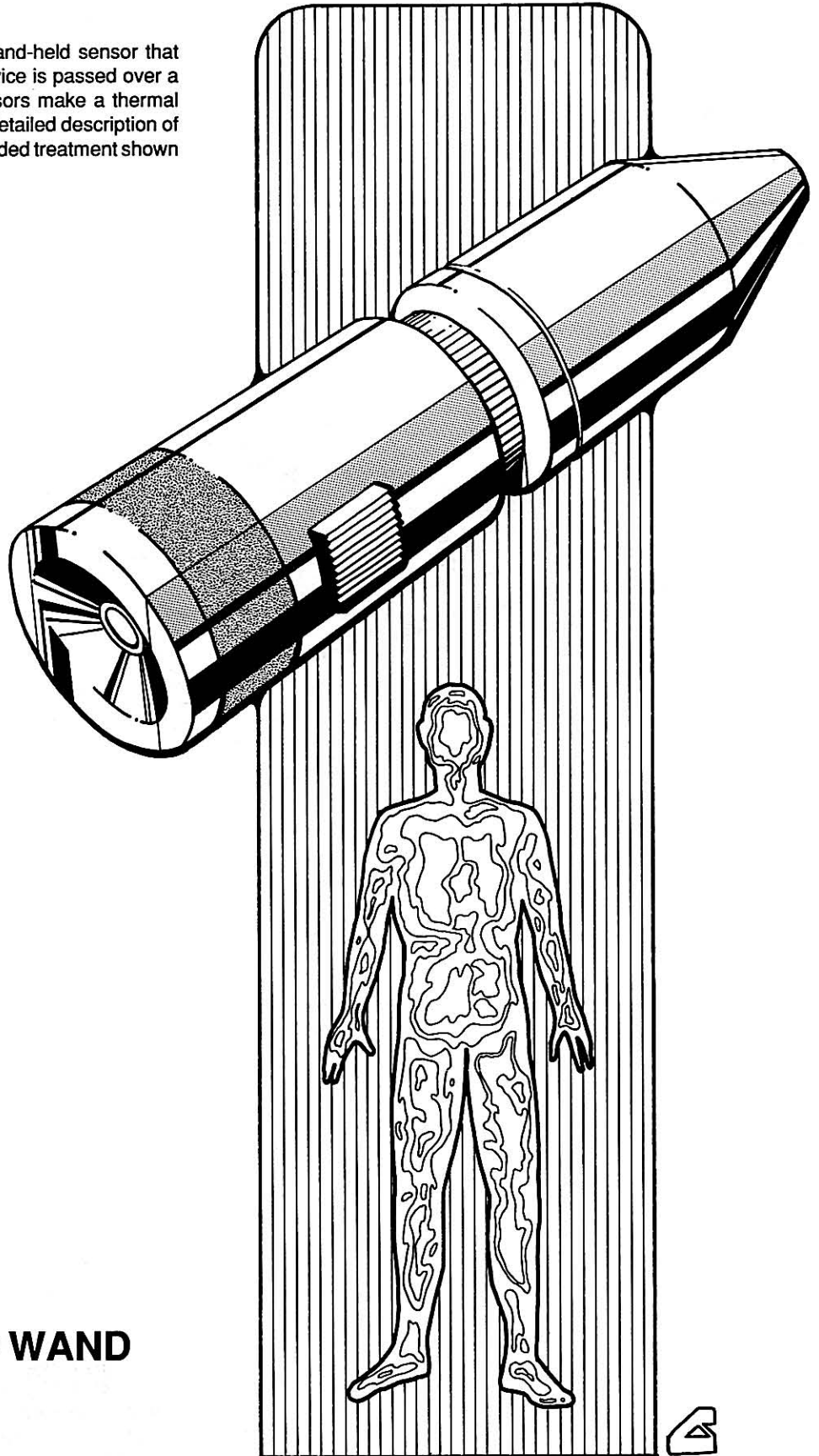

DIAGNOSTIC WAND



DIAGNOSTIC BED

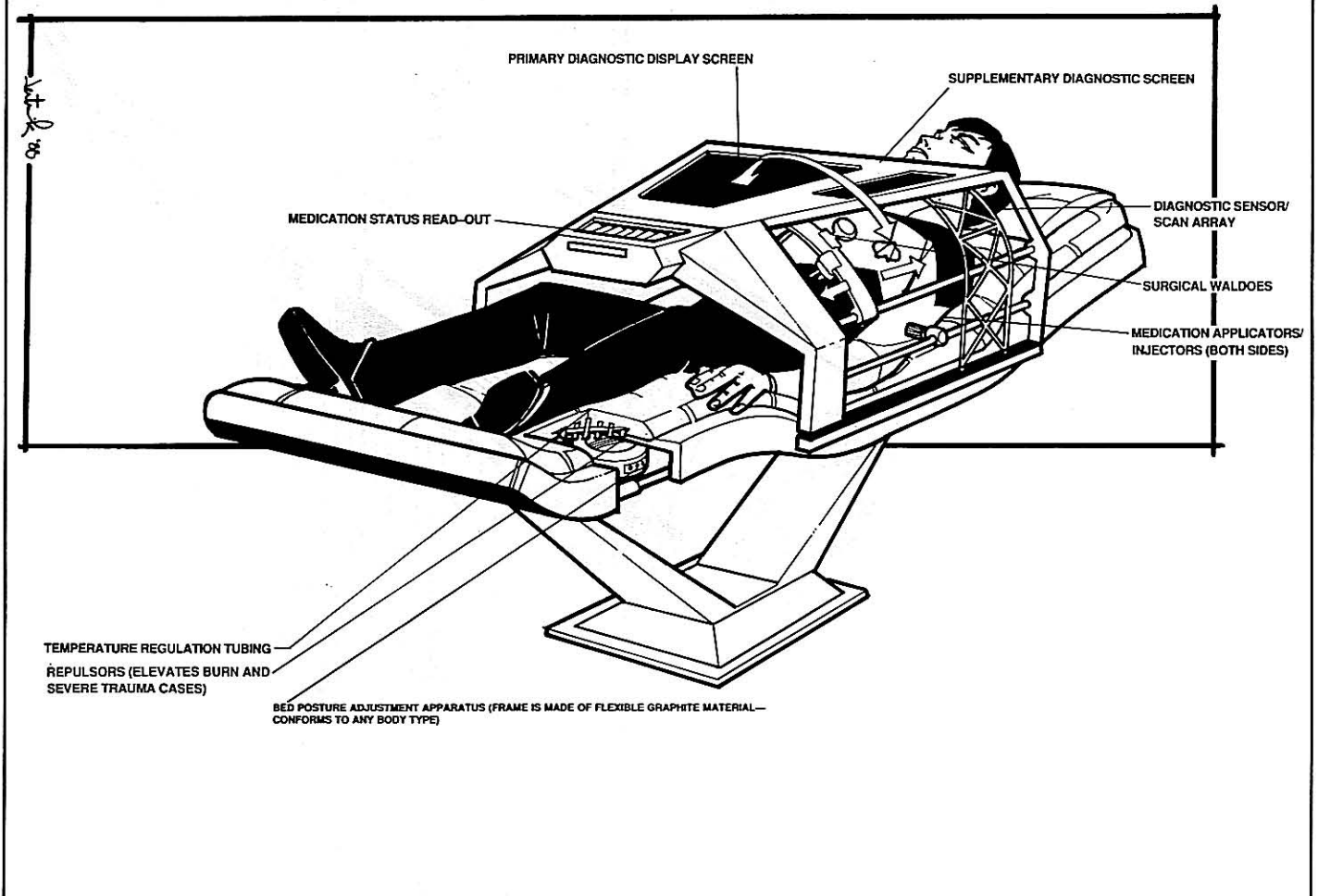

Diagnostic Bed

The diagnostic bed is a multi-function patient analysis and life-support system composed of three elements. Woven into the compression cushions lining the length of the bed is an enhanced sensor web that provides continuous data on vital signs. The folding support platform normally positioned over the patient's torso holds a standard sterilization field, dispensary systems for intravenous injections, solution preparations, a cardiovascular stimulator, and an auto-respiratory stimulator. An expanded wall panel display above the patient's head provides continuous readouts of vital life signs, with an alarm system that is activated when readings fall below certain thresholds. The wall display can also provide a three-dimensional holographic display of the patient for use during medical consultations.

Medical Support Kit

This standard first-aid kit provides an Away Team with a diagnostic wand; a duralyne hypo spray; three 100 cc ampules each of trioxide respiratory stimulant, dimedalyne pain suppressant, and elsendatrine stimulant; four 4.5-centimeter plasticene splints; sterilized pressure bandages; fluorocarbon skin graft replacements; anti-radiation tablets, water purification tablets; and spare data crystals and power packs for a medical tricorder.

MEDICAL SUPPORT KIT

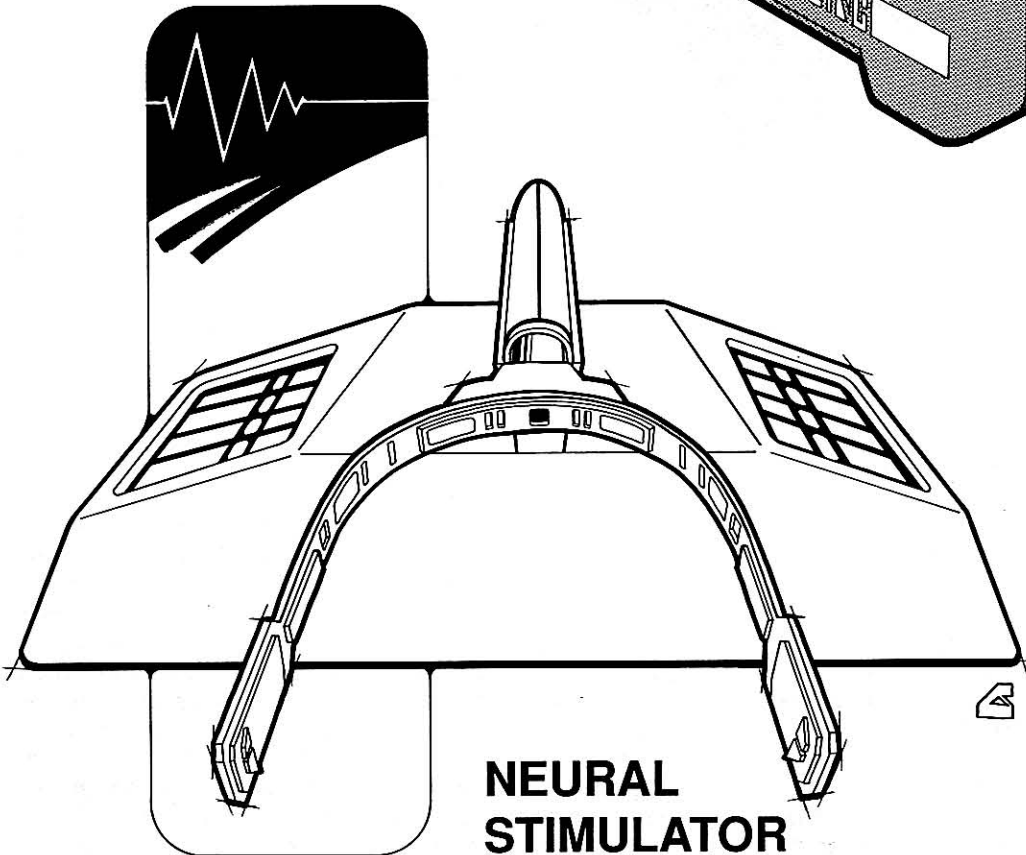
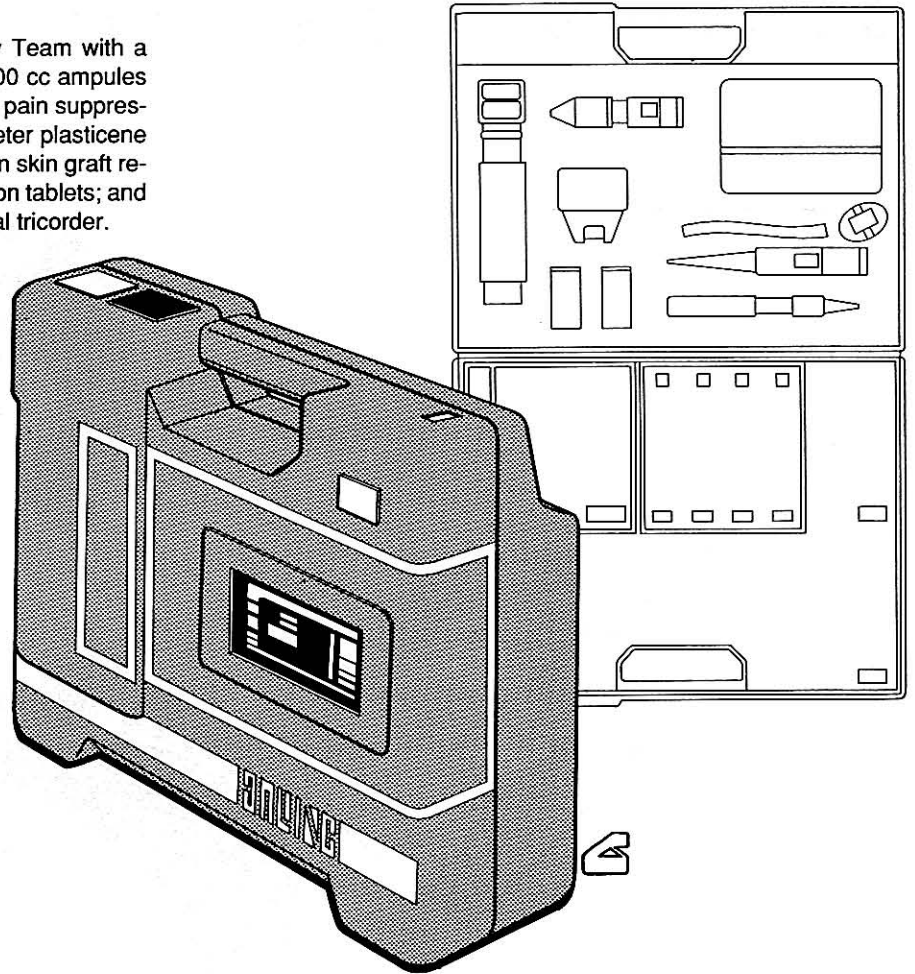

NEURAL STIMULATOR

Neural Stimulator

This device is used in cases of extreme injury or illness when the physician hopes to improve vital signs through neural stimulation. The device delivers a phased voltage beam directly into the nerve endings in the brain cortex. Phased transducers on either side of the main lobes oscillate several microvolts of direct current stimulation per second.

SPECTROSCOPIC VISION ENHANCER

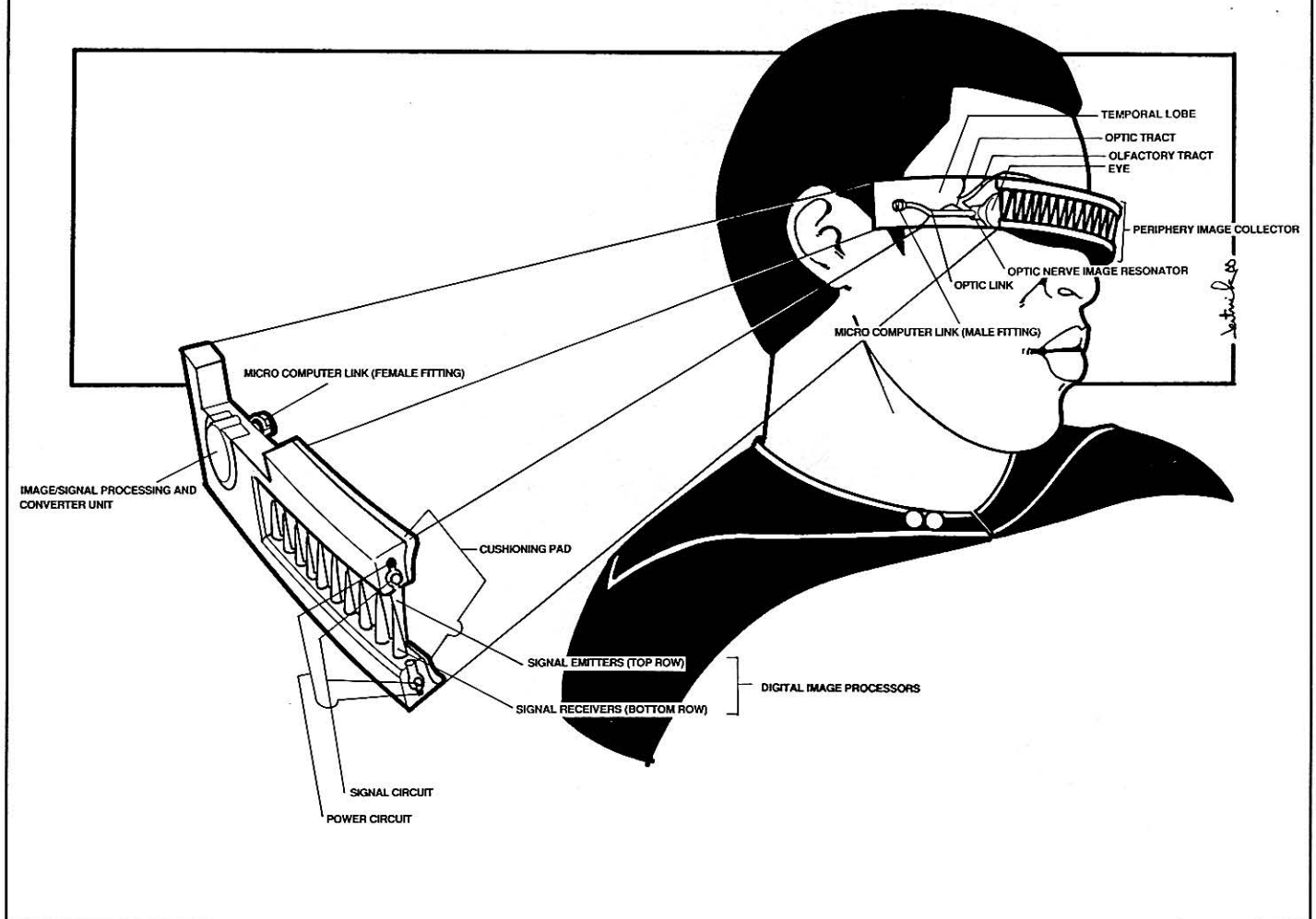

Spectroscopic Vision Enhancer

A breakthrough in brain-computer linkage, the Spectroscopic Vision Enhancer offers the handicapped individual an alternative to sight. Microcomputer links imbedded beneath the skin at the sides of the forehead send data to a periphery image collector. Digital image processors translate analog signals from the surrounding electromagnetic spectrum, then process and send them into the synaptic reaches of the brain via an image resonator. The result is a false color "picture" of the patient's surroundings, ranging from thermal images at the infrared end of the spectrum to the cold blues of ultraviolet. Specially designed versions of this device can provide image magnification; analysis of object composition, mass, density, and atomic structure; and the presence of energy flow patterns. With prolonged use, however, the Vision Enhancer causes frequent headaches as the brain attempts to adjust to the "artificial" influx of information.

Personal Sensor Nets

Although a Personal Sensor Net cannot compare to the detailed images of the Spectroscopic Vision Enhancer, the device does help the sightless while causing less discomfort. A Personal Sensor Net is a collection of hundreds of sensor probes fashioned in the shape of small buttons, pins, or gems worn as jewelry or as part of an individual's clothing. These sensors provide unique data references to a patient's surroundings via processor resonators implanted in the patient's skull. Though the wearer has no sense of vision, he can perceive people and objects as mental images based on hundreds of reference points. A personal sensor net can even provide such information as respiration and heart-beat rates for others nearby and allow the wearer to gauge distances with precision.

MARK V PERSONAL PHASER

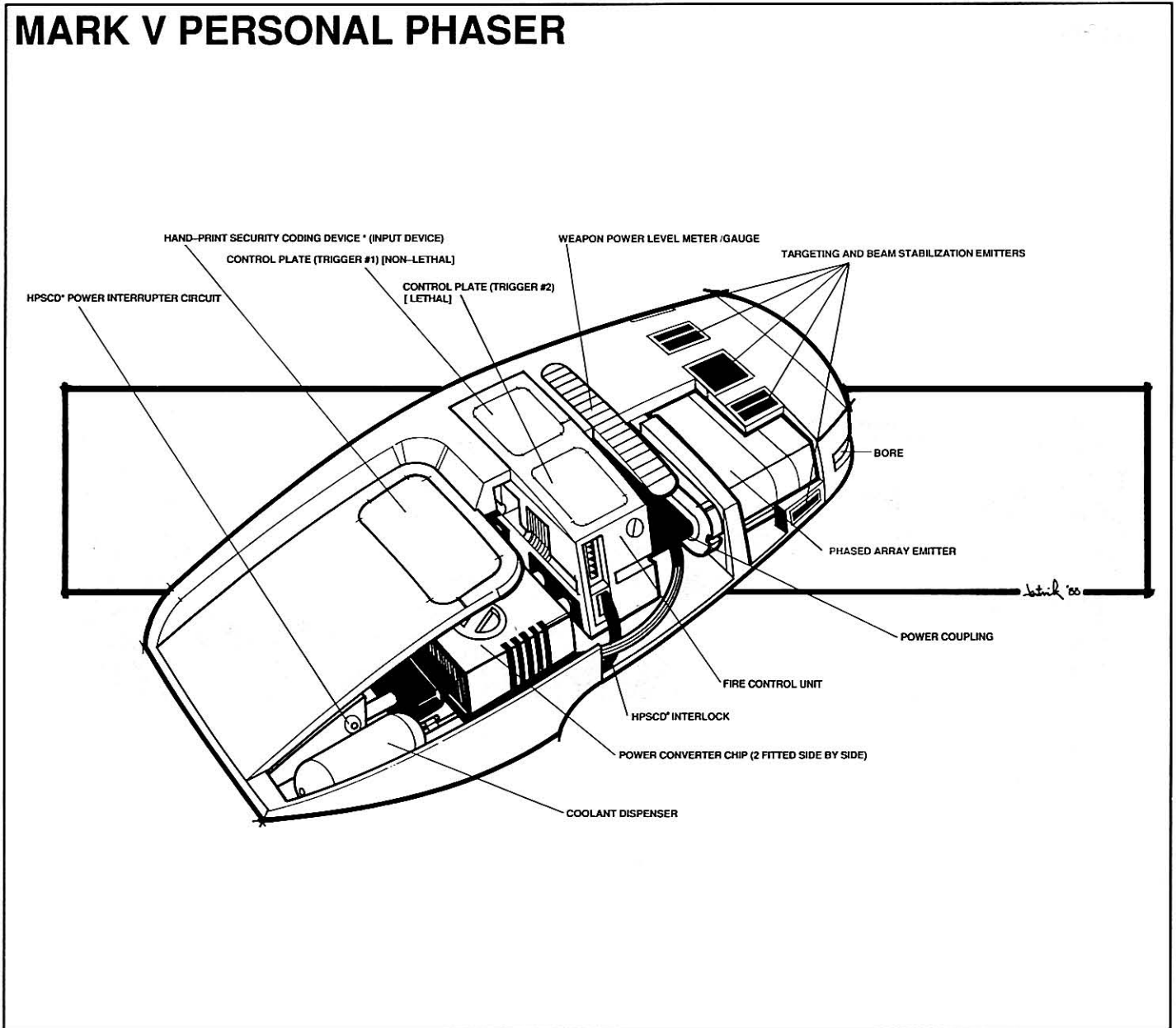

PERSONAL WEAPONS

Mark V Personal Phaser

This small, hand-held, easily concealed side arm combines the latest in microcircuitry and energy flow alignment techniques. Indeed, the Mark V boasts a maximum power output three times that of earlier Mark II models. Characterized by its wafer-thin styling, the Mark V phaser is less than 10 centimeters long and 2.5 centimeters wide. Inside this slim housing are two power converter chips that can be recharged from portable energy packs or from an adaptable connector on standard tricorders. Unique to this design is the hand-print security coding, which makes each

weapon responsive only to a single set of fingerprints. The surface plate of the Mark V Phaser contains two pressure-sensitive energy regulators; the left-hand activator controls non-lethal energy discharges and the right-hand plate deals with more destructive energies. In normal use, the user selects the amount of energy to be released from the appropriate activator by the amount of finger pressure on the proper plate, thus eliminating the need to adjust settings at a critical moment. A 30-second-delay self-destruct can be initiated by firmly depressing both activator plates simultaneously for ten seconds.

MARK VI BATTLE PHASER

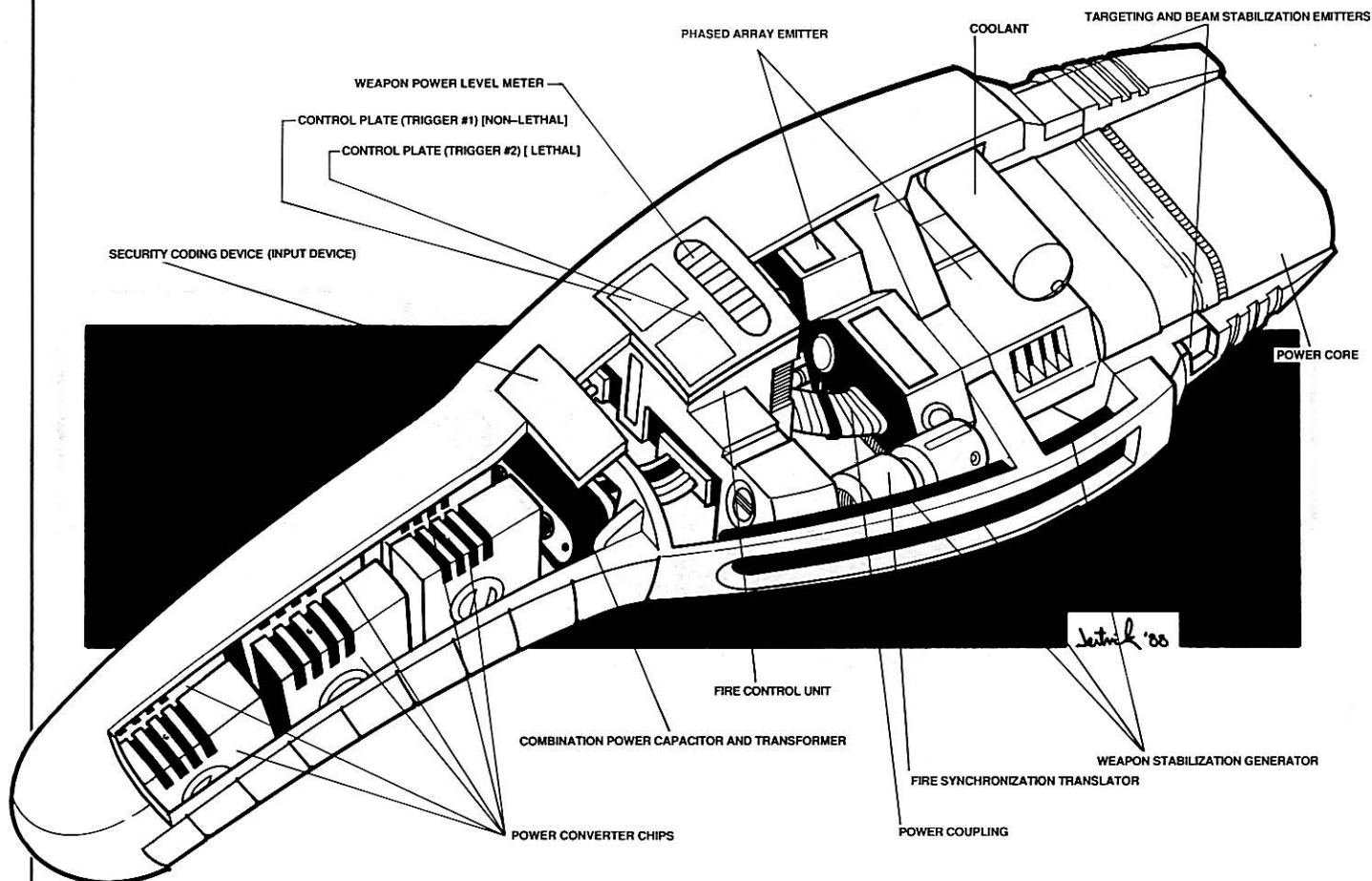

Mark VI Battle Phaser

When ship's personnel are expecting danger or need a show of force, the heavier Mark VI Battle Phaser is an appropriate weapon. With its broom-handle design and width-mounted power core, this bulky but light weapon is usually worn in a velcro hip holster that doubles as a recharging unit. Developed by Wilson Energies Limited, the Mark VI functions as a two-in-one system. It combines two interlocking phased-particle beams in a collimator field to produce a single-charged particle beam. The resulting firepower is far greater than in earlier models, and is capable of

penetrating the strongest alloy or reflective defense armor at close range. By altering the frequency of the beam's dispersal pattern, the Mark VI's power collimator can also reduce the electron flow, generating a simple laser or a variety of plasmalike beams suitable for use in non-combat emergencies when communications or energy transmissions are required. As with other phaser designs from Wilson Energies, the Mark VI offers a variety of lethal and non-lethal settings. Static tests have shown that the weapon can fire at full power for two and a half hours before power is completely drained.

MARK VII PHASER RIFLE

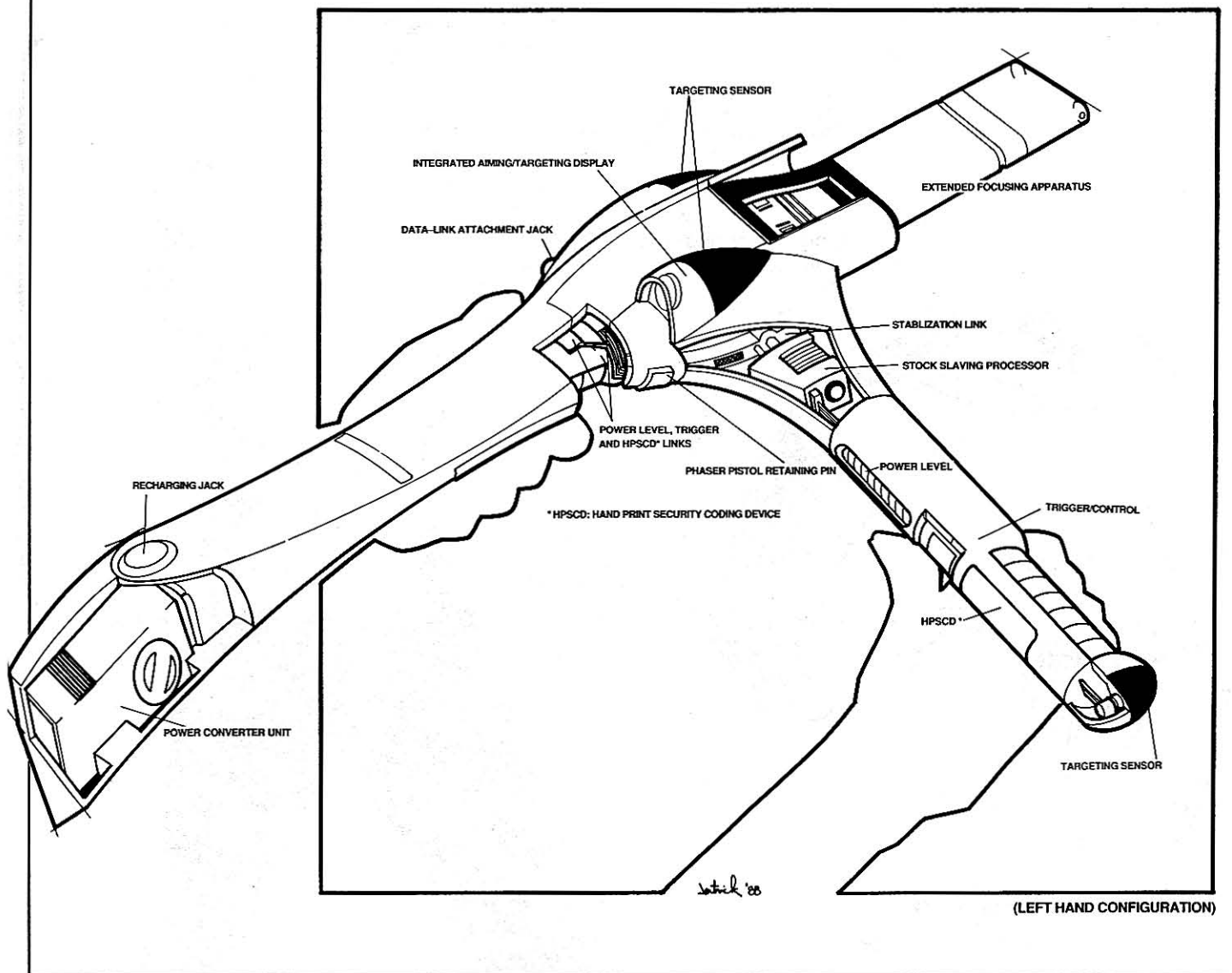

Mark VII Phaser Rifle

The Mark VII Phaser Rifle was designed for use by Federation Security and Marine detachments in prolonged combat conditions against heavily armed opponents. Standing 1.2 meters in length, the Mark VII mounts a standard Mark VI with extended power packs in the weapon's duralloy stocks. Extended focusing apparatus along the barrel permit pinpoint accuracy with the high-energy beam. Separate attachments for data links to tricorders allow the use of several computer-enhanced optical aids, an early-warning system, improved fire-control, and automatic tracking.

BATTLE ARMOR

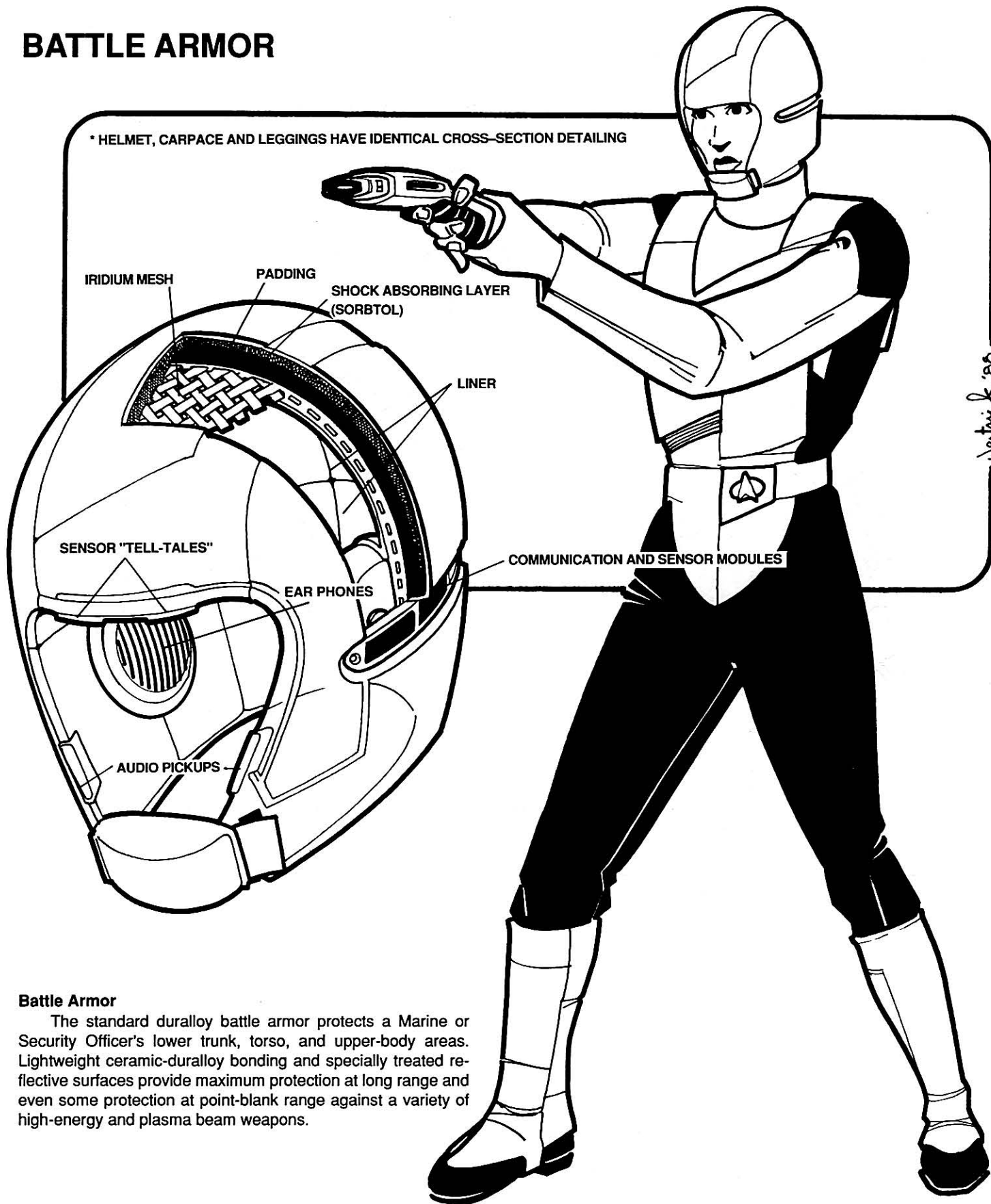

Battle Armor

The standard duralloy battle armor protects a Marine or Security Officer's lower trunk, torso, and upper-body areas. Lightweight ceramic-duralloy bonding and specially treated reflective surfaces provide maximum protection at long range and even some protection at point-blank range against a variety of high-energy and plasma beam weapons.

ENGINEERING KIT

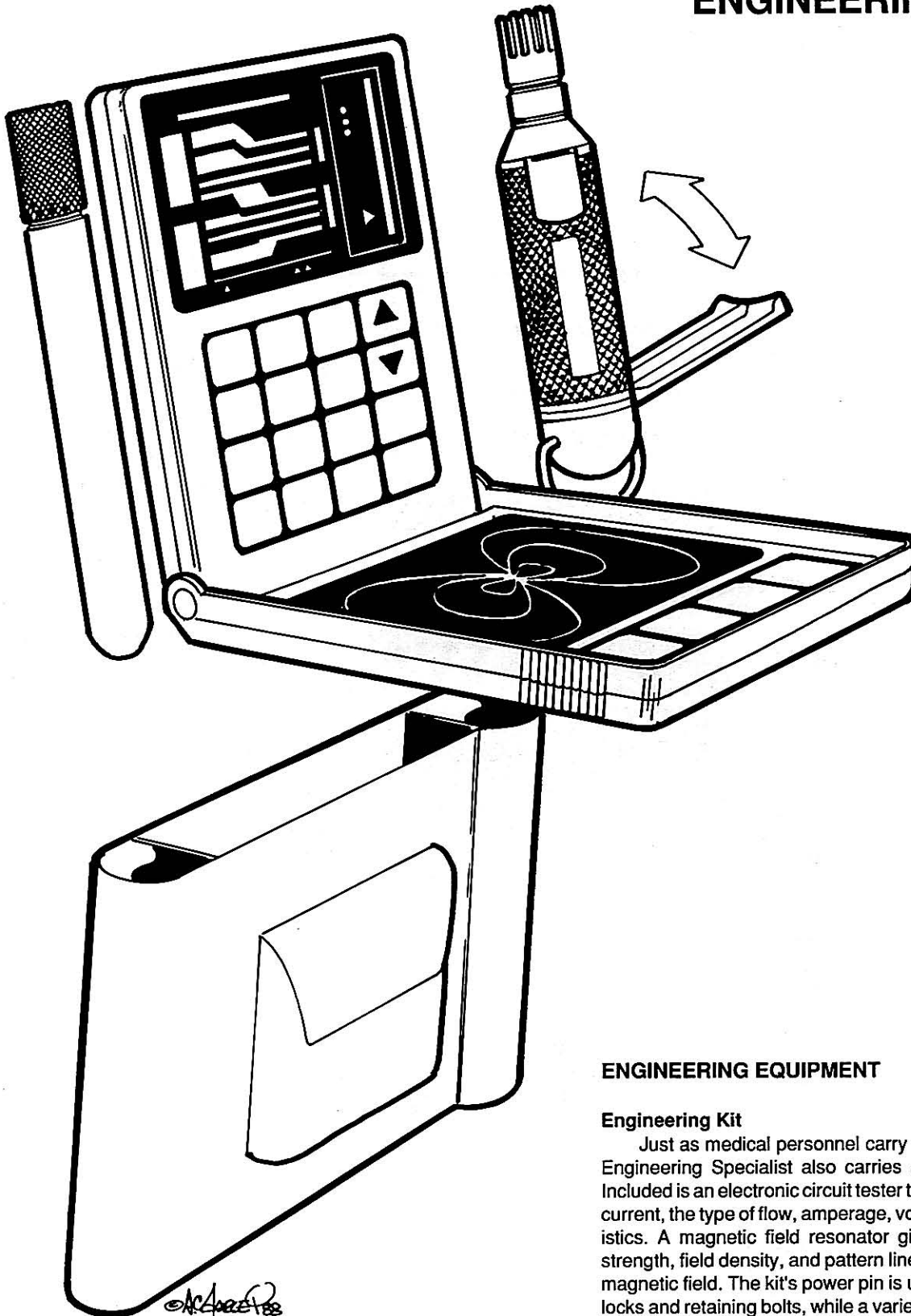

ENGINEERING EQUIPMENT

Engineering Kit

Just as medical personnel carry specialized equipment, an Engineering Specialist also carries a standard kit on his hip. Included is an electronic circuit tester to determine the direction of current, the type of flow, amperage, voltage, and other characteristics. A magnetic field resonator gives data on the location, strength, field density, and pattern lines of a magnetic or electromagnetic field. The kit's power pin is used for replacing paneling locks and retaining bolts, while a variety of spare power cells and a free-floating laser illuminator round out the engineer's troubleshooting kit.

ANTI-GRAVITY CONNECTORS

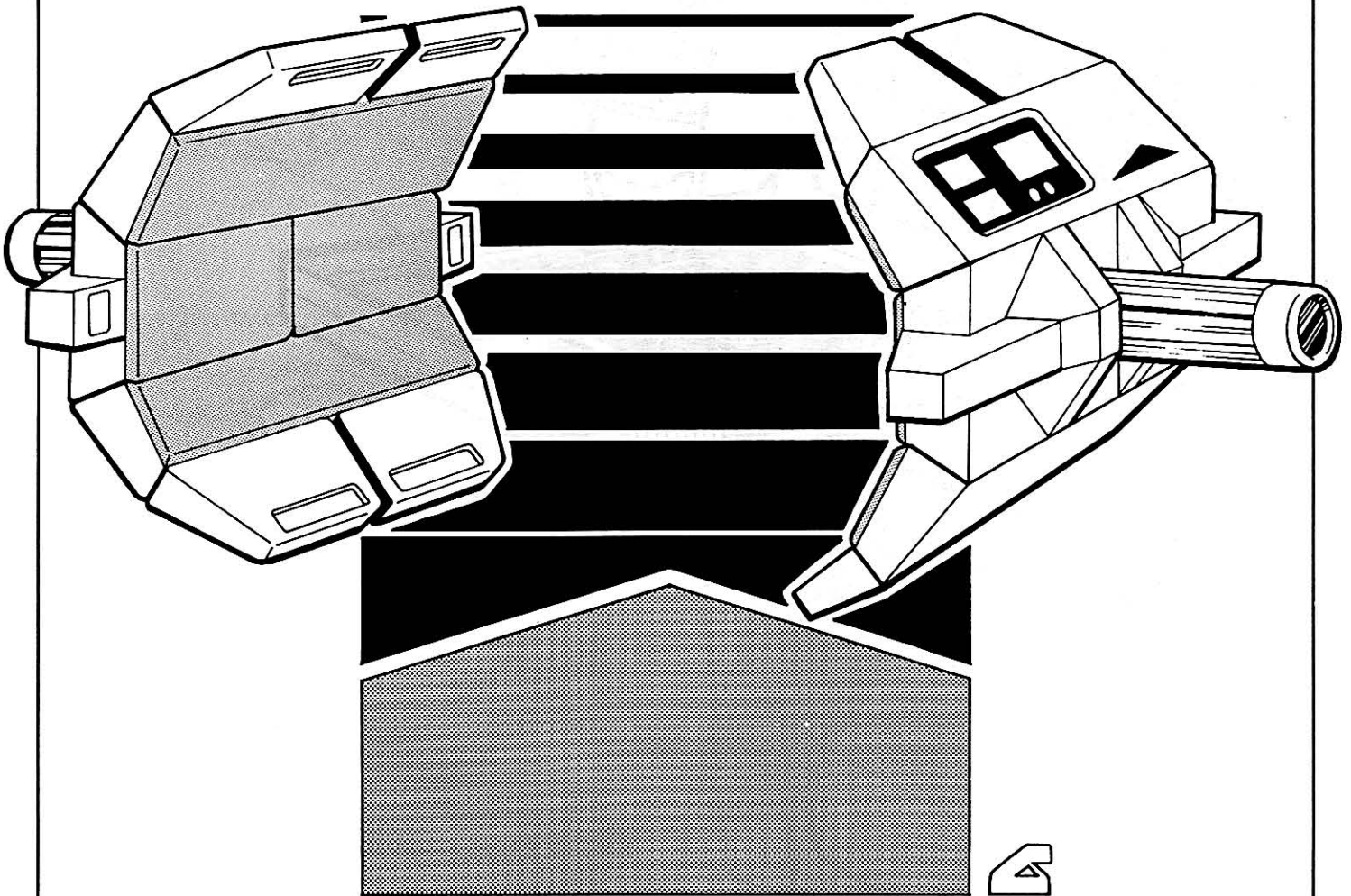

Anti-Gravity Connectors

Engineering Specialists use Anti-Gravity Connectors to move bulky or heavy equipment. These devices come in various shapes and sizes, but most common are the hand-held models. When attached in pairs to the sides of an object, the anti-gravity connector creates a counter-gravity field that makes the object virtually weightless and easier to handle. The radius of the counter-grav field varies from one to ten meters.

PLASMA TORCH

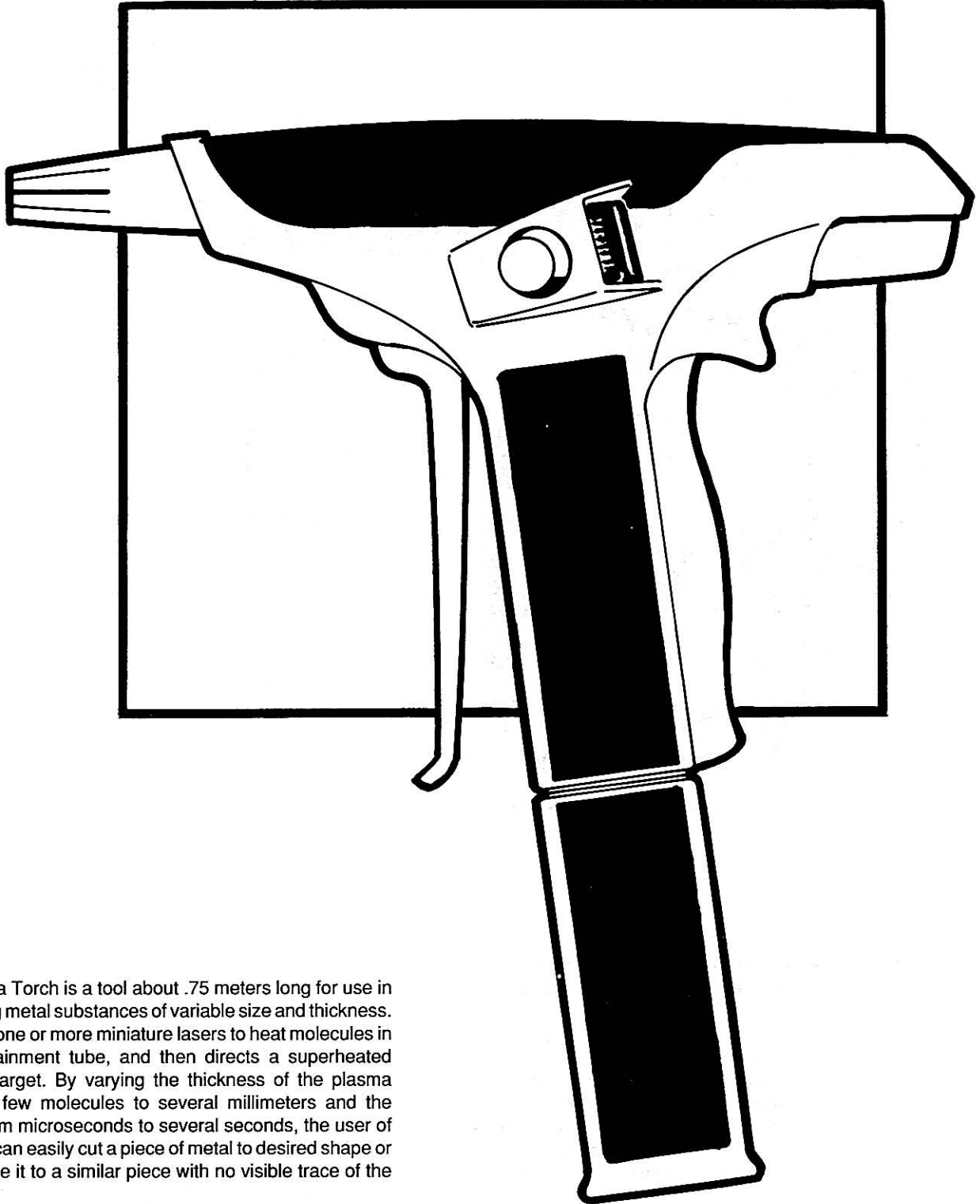

Plasma Torch

The Plasma Torch is a tool about .75 meters long for use in cutting or joining metal substances of variable size and thickness. The torch uses one or more miniature lasers to heat molecules in a plasma containment tube, and then directs a superheated stream at the target. By varying the thickness of the plasma stream from a few molecules to several millimeters and the contact time from microseconds to several seconds, the user of a plasma torch can easily cut a piece of metal to desired shape or thickness or fuse it to a similar piece with no visible trace of the joining.

MOLECULAR BINDERS

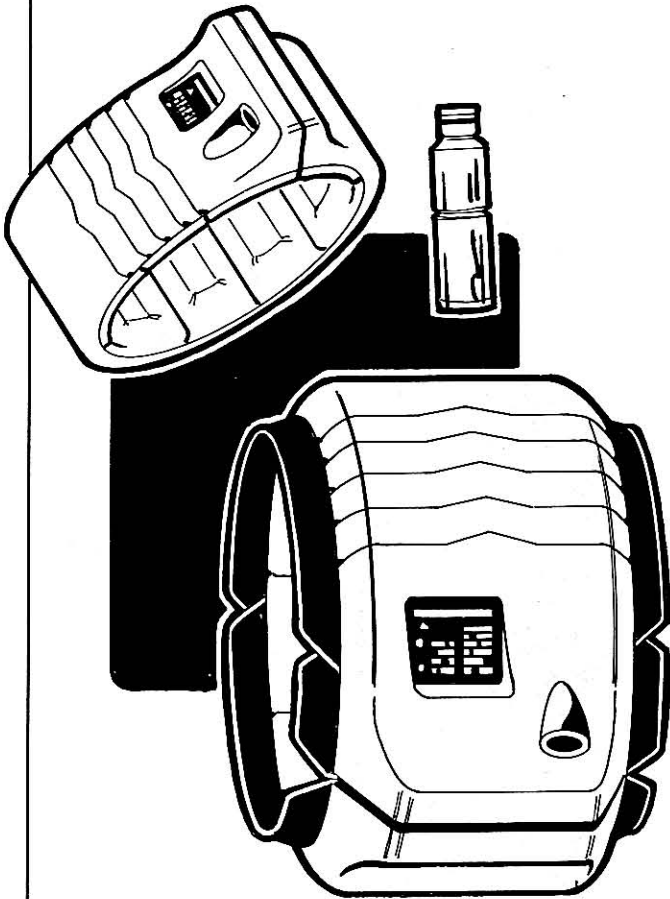

SECURITY ORDNANCE

In addition to personal weapons, Security personnel have access to various specialized equipment, described below.

Molecular Binders

Security personnel occasionally need to restrain an individual rather than rendering him or her unconscious. For this, they use molecular binders, typically in the form of wrist and ankle restraints. Microscopic fields of force around each restraining band increase the density of the air molecules adjacent to the subject's wrist or ankle. The result is a strong force field restricting the smallest amount of movement in any direction. The settings can be varied according to the subject's race and build, but the effect is always that of a vise-like grip.

BIO-TRANSDUCER PACKS



Bio-Transducer Packs

Intended for use in crisis situations, the Bio-Transducer Pack is a hand-held generator similar in size and shape to a medical tricorder but with almost the opposite function. The device sets up an "asynchronous" biological field that disrupts the normal biological functions of the target, weakening the individual to a state of helplessness in a matter of seconds. Bio-Transducers are not perfect instruments of crisis containment, however. Studies have shown that the misuse can inflict accidental cardiovascular or respiratory failure. Conversely, some individuals—if sufficiently aroused—can overcome the effect of the Bio-Transducer long enough to inflict serious damage. Furthermore, the field generated is not selective, which means that Security leaders must be careful not to disable team members who have biological makeups similar to the intended target. For these reasons, some Security chiefs prefer to use phasers despite the Bio-Transducer's wide popularity and effectiveness.

PHOTON CANNON

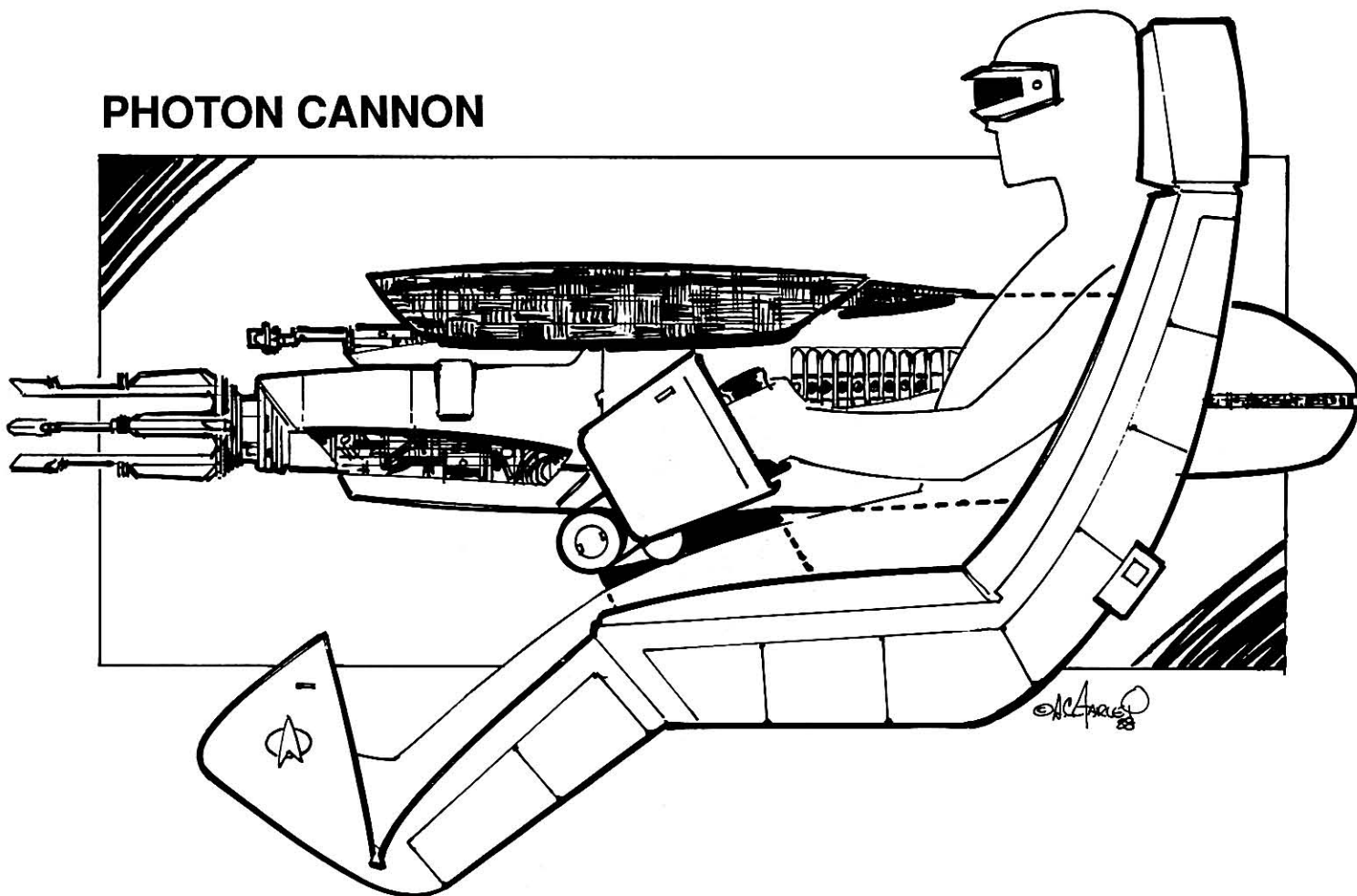

Photon Cannon

To protect members of an Away Team from hostile indigenous populations or to abort a close assault on a ground installation, Security can use one of several Photon Cannons stored aboard ship. The Photon Cannon is a short-range, but incredibly destructive, weapon descended from laser and phaser projectors. Once the cannon is beamed down, it can maneuver on a self-propelled platform. It has access to virtually limitless power from the command ship's microwave relay projectors to accelerate high-energy anti-photons in a magnetic chamber. When the cannon is fired, the stream of charged particles is powerful enough to penetrate the heaviest armor or energy-screen defenses. Because of the short half-life of the rapidly decaying anti-photons, the Photon Cannon's range is limited to two kilometers. This is sufficient to meet most ground threats.

Portable Security Computer

Similar to the standard Battle Computer used by Star Fleet Marines, this portable device provides specially trained Security teams with up-to-the minute tactical and strategic information via microwave links to a ship's main computer. The portable computer can report enemy positions, movement, and disposition obtained from shipboard sensor relays, and also has control links to portable motion detectors that can be spread over a wide range of terrain. In addition, the Security Computer can reliably predict enemy tactical options based on stored data about dozens of warlike races previously encountered by Alliance forces. The device also analyzes enemy strengths and weaknesses based on tricorder readings and examination of terrain.

PASSIVE EM FIELD GENERATORS

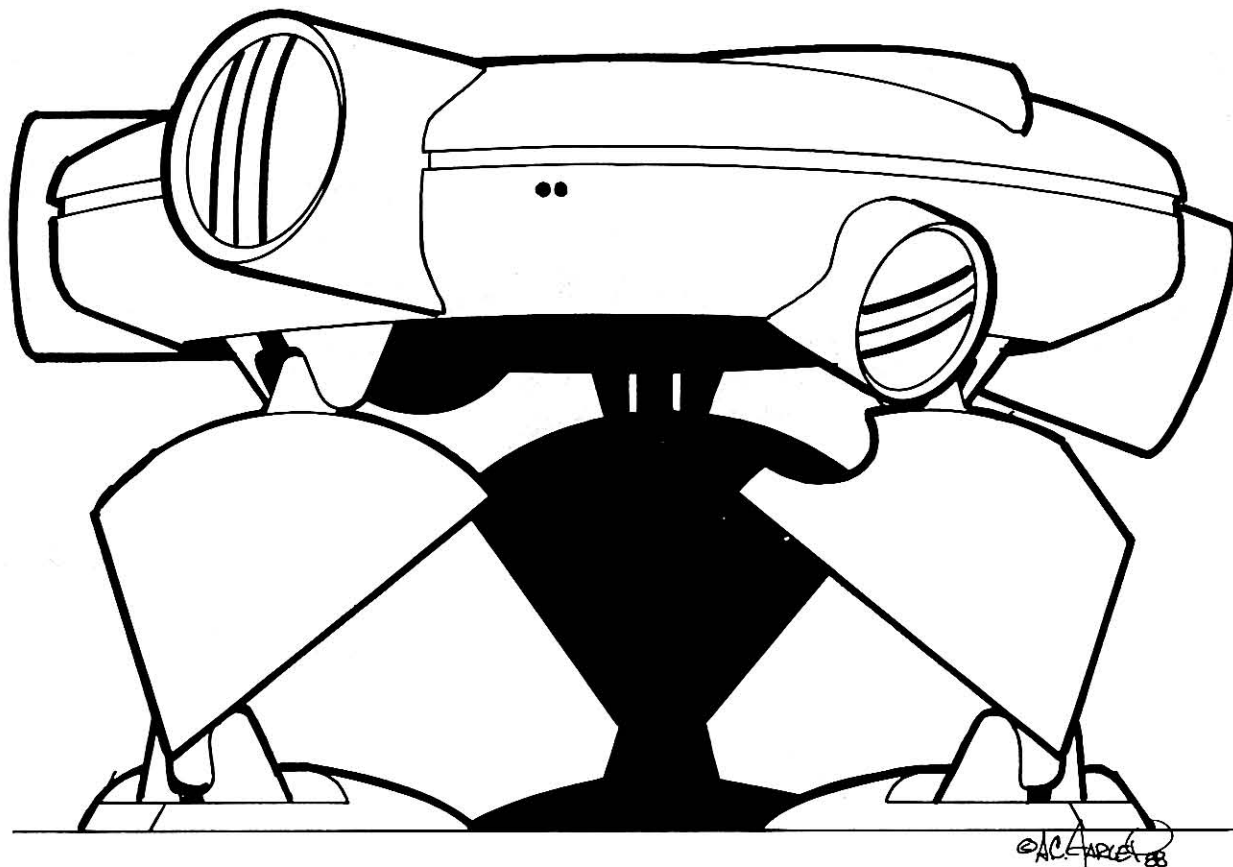

Passive EM Field Generators

Similar to the Bio-Transducer, the EM Field Generator is designed to contain large numbers of hostile creatures whose physiology is non-humanoid. The generator projects a field of high-frequency alpha and alternating theta waves, which react with the hostile creature's cerebral cortex. The result is usually extreme disorientation, passivity, and often loss of muscular control as the normal brain signals are disrupted. The EM Field Generator is effective against most, but not all, non-humanoid life forms. The device is most often used as static defense for a ground installation.

Anti-Matter Grenade Launcher

The Anti-Matter Grenade Launcher delivers a less powerful blast than the Photon Cannon, but it is still lethal enough and can cover a wide area. With its 300-degree arc of fire and range of 550 meters, the launcher is a good supplement to the Photon Cannon when ground-based Security teams are under attack or wish to provide fire support. A single grenade contains 2.8 grams of anti-matter, capable of destroying or immobilizing targets within its firing arc and range.

Personal Equipment

Following are brief descriptions of personal equipment commonly used by civilian or Star Fleet personnel.

Identification Disks

These small silicon disks are the 24th-century equivalent of old-style identification papers. Combining the functions of identification and authorization, these easily carried disks can be programmed easily into the computer system of a ship or ground installation. In addition to providing an individual's service record, educational background, and personal history, the Identification Disk contains medical, financial, and legal information. Thus, the disk could provide vital medical data if the owner were unable to speak in a serious physical crisis. The disk can also verify credit anywhere in the Federation.

Anti-Gravity Conveyor

The Anti-Gravity Conveyor is used to transport luggage in heavy-gravity environments or by handicapped persons so that they can be more self-reliant. One conveyor can lift half a metric ton to a height of ten meters. The unit must be recharged once a year.

Translator Band

Because of the numerous races represented aboard any Starfleet vessel, Translator Bands have become standard-issue. These bands replace the older universal translators, and can render equivalent speech patterns for every language represented in the Federation as well as numerous independent, Romulan, Orion, and Klingon dialects.

Valet Packet

To conserve space, civilian crew members are provided with Valet Packets for storage of personal items. Similar in size and shape to a small briefcase, each Valet Packet contains the encoded computer patterns of the owner's individual wardrobe, condensed onto silicon data disks. A processing unit in the owner's living quarters can read the disk and reassemble a desired article of clothing into its original form in seconds.

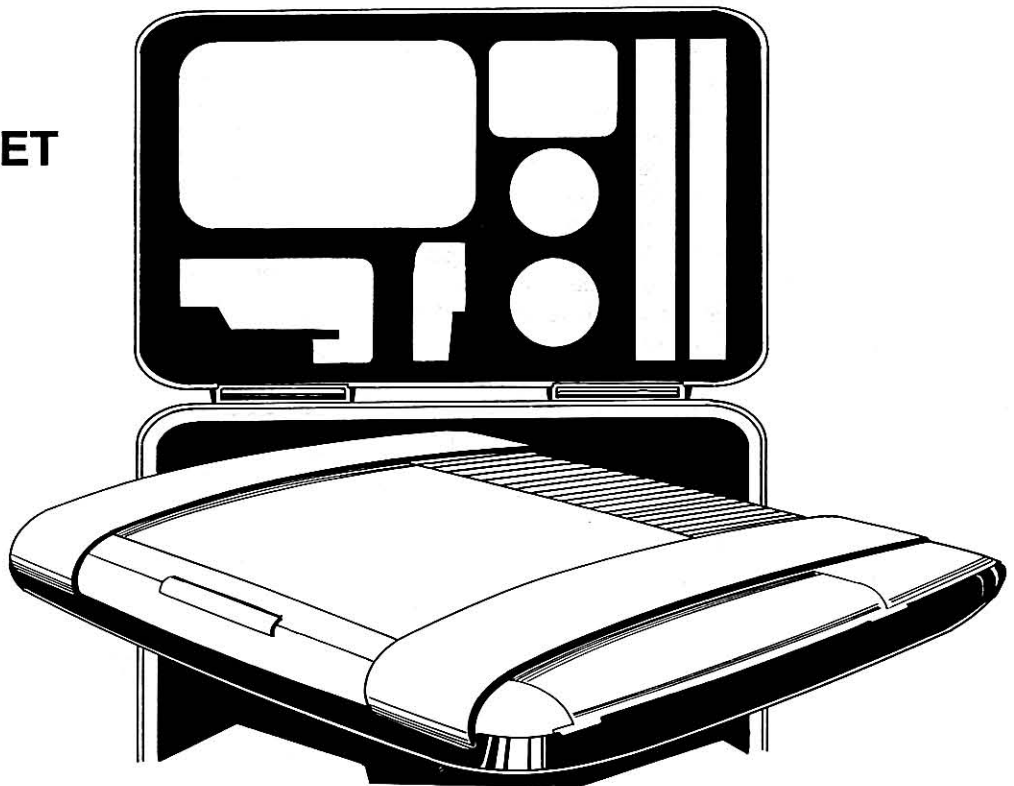
VALET PACKET

STARSHIP WEAPONRY

This section provides declassified information on the *Galaxy* Class cruiser's main weaponry systems. Still classified at this time is specific data on the main fire control, tracking, and Tactical Control Computer systems.

PHASER SYSTEMS

The *Galaxy* Class cruiser, as befitting a vessel of its size and importance, mounts the heaviest array of offensive and defensive weapon systems of any Federation starship. The main strength of this class lies in the battery of twelve FH-15 phaser banks located along the central command saucer section. Fire control for these weapons permits them to target multiple enemy craft for simultaneous attack, as well as to pinpoint locations along the surface of any hostile vessel in order to cripple or immobilize enemy craft with minimal loss of life. In addition, a collimator ring installed in the underbelly of the saucer section acts as an energy collector. By allowing phaser power to be "massed" from numerous energized weapon hard points, this feature gives the *Enterprise* a 300-degree arc of fire around the ship. Supplementing this main weapon system are ten FH-10 phaser banks mounted along the dorsal stardrive section. These phasers allow the main saucer section to fight as an independent entity should it become detached for some reason.

PHOTON TORPEDOES

In addition to advanced phaser energy weapons, the *Galaxy* Class mounts a variety of Mark 4a photon torpedo tubes on both the saucer and star drive sections. Besides providing long-range protection, these torpedo-mount designs can operate in a proximity-blast mode. This feature allows for a good show of force without inflicting serious injury on a would-be enemy. With the upgraded fire control systems linked to the ship's central computer system, these automated mounts can be reloaded and fired repeatedly with minimal time delays or provide multiple-launch barrages at a moment's notice. In trial runs, the new photon torpedo systems installed on the *Enterprise* were capable of providing an eight-missile spread of torpedoes in the space of ten seconds, with all tubes reloaded and ready for continual fire at multiple targets as a matter of course.

ZERO-LETHALITY WEAPON SYSTEMS

In keeping with Star Fleet's policy of preventing hostile confrontations whenever possible, considerable research and development has gone into the search for advanced weapon systems of a non-lethal nature that a commander might use to show force without inflicting casualties. As a result, an experimental system has been developed, and is currently being evaluated aboard the *Galaxy* Class cruisers. This experimental system is known as the Disruption Banks.

Disruption Banks

A non-lethal weapon currently under evaluation aboard the new *USS Enterprise*, Disruption Banks are not to be confused with the highly destructive Klingon energy weapon known as a disruptor. Drawing directly on energies created by the ship's multiple warp-field generators, Disruption Banks employ a powerful electromagnetic-gravimetric field. Tying this in to the ship's deflector shield control systems creates a power field strong enough to neutralize the normal electronic energy emissions from either ground-based or shipborne power systems, effectively disrupting normal power distribution. This experimental system cannot as yet penetrate planetary or ship-mounted deflector or defense screen systems already in place. In the absence of these shielding systems, however, this disruption field seriously impairs an opponent's ability to engage in hostile actions, hopefully forcing a nonviolent resolution to a crisis situation. Present Disruption Bank designs can neutralize the energy outputs of a small planetary metropolis or a vessel of equal size and class at a maximum distance of 10,000 kilometers.

DEFENSIVE SYSTEMS

Primary Defenses

Defensively, the new *Galaxy* Class cruiser is as impressive at taking punishment as it is at giving it out. Automated defensive networks tied in to the ship's central computer system continually monitor intrusive high-energy readings in a 360-degree global arc with a radius of some 1.2 light years. Any energy transmission or emission detected within this radius triggers the ship's defensive shields to raise in the direction of the perceived intrusion. Moreover, the ship's AICS computer can react to unseen dangers (be it enemy craft suddenly decloaking or a natural object or phenomenon on a collision course) by initiating automatic helm overrides to avoid collision faster than any Human could react.

The *Galaxy* Class is the first vessel to make use of the FSS-M shielding system. A radical departure from defensive systems of earlier vessel classes, the FSS-M uses multiple layers of shielding, which permit temporary increases in shield power in any given sector of the ship's defenses.

Internally, separate security computers linked to the main onboard control system keep track of all onboard personnel through the continuous monitoring of vital sign readings from biocommunicators. The presence of any unauthorized life forms signals an alert-status indicator at the Security Chief's station and on the threat board located on the Flag Bridge. If necessary, ship's transporters can beam security teams to the threatened areas. In extreme cases, the ship's computer will begin a self-destruct sequence, provided the Captain and Executive Officer approve, as explained below.

PHOTON TORPEDOES

Starfleet Naval Construction Command NCC 1701-D	
Deck Plans	
Class: Galaxy	Vessel: USS Enterprise
View: Photon Torpedo Launcher	Executed: <i>Chris Bean</i>
	Approved: <i>G. B. Paul</i>
Does not reflect yard changes	

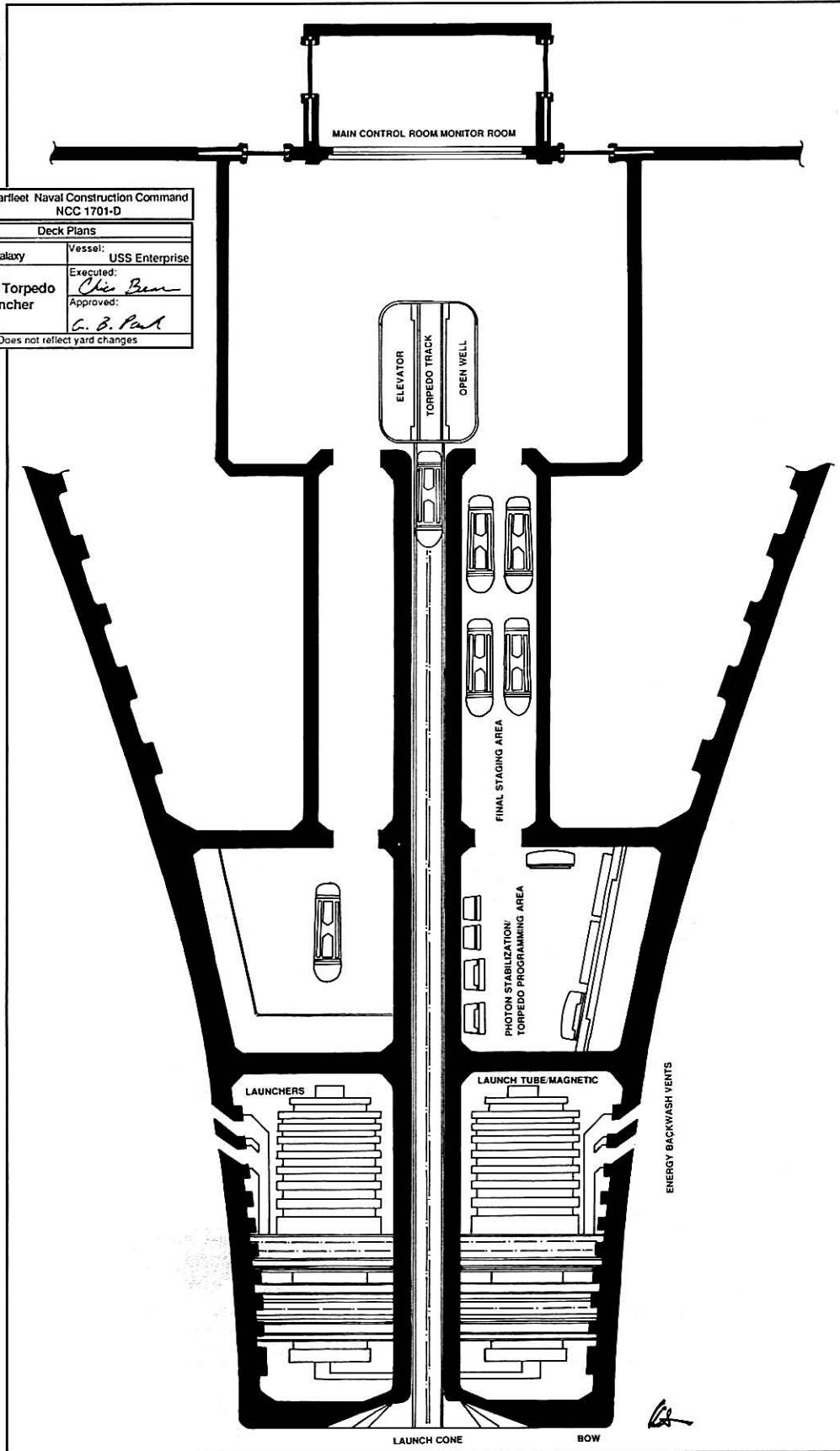

SECONDARY DEFENSE SYSTEMS

Automated Ship's Defenses

In addition to the *Galaxy* Class cruiser's primary defensive shielding systems, the ship's intelligent computer system provides other automated defensive systems. Among these are an anti-collision program that allows the main computer to override helm and navigational manual control settings to prevent imminent collision with any object the ship's defense shields cannot neutralize. In addition, the ship's Bridge Security Officer may activate a variety of computer-assisted evasive maneuver systems in the face of enemy attack. There are also perimeter defense alert systems that activate defensive screens if ship's sensors detect any large energy source or object massing more than 100 standard tons entering their radius. Though the *Galaxy* Class does not use gas agents as part of its internal defense systems, its security system can deny turbolift access to non-authorized personnel, as well as seal off various sections of the vessel to contain an intruder.

Space-Time Displacement

In extreme emergencies, the ship's Engineering Officer can use the ship's warp engines to create a localized space-time displacement. The engines normally derive their power from a matter/antimatter explosion. By changing the energy effect to one of implosion, the vessel can be displaced from one physical point in normal space to another point many light years away. Unfortunately, the effect of this maneuver is largely random. To prevent the ship from ending up inside a sun or large planetary body when it reemerges in normal space, the Engineering officer needs several hours for preparation and computations to maximize all safety factors.

Self-Destruct

Should the Captain exhaust all options and find his ship in danger of imminent capture, one last-ditch measure remains. To keep his vessel from falling into enemy hands, he may order a 60-second self-destruct sequence to blow up the vessel. The ship's computer is responsible to carrying out the order to self-destruct, but it will only take this desperate measure if assured of several important factors. First, the AICS will initiate the destruct sequence only if all civilians have been evacuated first. Second, the ship's log must present sufficient data to convince the AICS that all other courses of action have already been tried and failed. Finally, to initiate the final destruct sequence, the ship's Captain and First Officer must give the order jointly at a console that can verify their voice and palm prints on the ship's main engineering level.

Forward Placement Deflectors

In addition to its standard defensive shielding system, the *USS Enterprise* also boasts a new system. Unlike the standard screen, which projects a protective "cocoon" around the vessel, the Forward Placement Deflector (FPD) system projects outward a strong energy field that can envelop small objects, or even other vessels, at extreme range. The FPD system can also assist a friendly vessel in distress by buying it time to permit evacuation of ship's personnel or else to shield another craft from solar radiation or asteroid damage while minimizing the risk of similar exposure to the *Galaxy* Class vessel itself. The FPD system currently has a maximum operational range of 25,000 kilometers and can simultaneously cover up to four separate target locations in a 360-degree arc.

Tractor Beam Emitter

The tractor beam emitter is a force-field device that can focus a wave/particle beam in either a repelling, attracting, or mutually repelling and attracting mode to seize, hold stationary, repel, or attract large objects in the space surrounding the ship's exterior. On the *Enterprise*, the tractor beam emitter can pitch a full 180 degrees and yaw 360 degrees, allowing it to function at almost any angle. To hold an object stationary, the device is set to mutually attract and repel, which locks the object in space relative to the ship. To haul an object into a cargo holding bay, the beam is set for attract only. Repel mode, of course, pushes the object away from the vessel. The tractor beam has its limits, however. Its range does not extend beyond 20,000 kilometers, because the beam wave particles are short-lived and will disintegrate into by-products at longer ranges.

Warp Drive Operation

The main propulsion system of the *Galaxy* Class exploration cruiser is the FIF-2M multi-field warp drive. Under normal operation, the FIF-2M warp drive system can propel the cruiser at a speed of Warp 8 (8 x 8 x 8 x 8 x 8 x the speed of light), with emergency speeds of Warp 9 and beyond. At the heart of this massive drive system is the dilithium crystal assembly, which controls the matter/antimatter collisions.

Dilithium is the only material yet discovered that can withstand exposure to antimatter particles for limited periods of time. Because of its unique crystalline structure, dilithium can hold antimatter suspended in the empty spaces between its atoms with only negligible annihilation of either dilithium or antimatter atoms. (If a crystal is defective, its structure will permit too many antimatter atoms to touch the normal atoms, thus degrading the structure of crystal itself at a measurable rate. This is known as dilithium decrystallization.)

The dilithium crystal is housed in an armored cradle of castroginium, the hardest substance known to man. During normal operation, matter and antimatter are introduced into the warp engine core through separate plasma injectors. The dilithium crystal assembly is placed directly in the path of the two matter streams, which would otherwise collide with an explosive release of energy. Instead, particles of antimatter slip through the face of the dilithium crystal housed in the assembly block, the antimatter atoms splitting apart in reaction to the dilithium atoms, then recombining in high-energy combinations.

These newly combined atoms receive additional energy charges as they pass from one crystal to the next in the assembly. Naturally, a few atoms of dilithium and antimatter will collide on the crystal's surface, but a surrounding magnetic coil contains the energy and radiation from these collisions.

The streams of dilithium-energized antimatter coming from the dilithium crystal assembly now split into separate plasma streams that are magnetically channeled along power-transfer tubes to the warp engine nacelles. Inside the warp engine nacelles, the "modified" antimatter streams meet their opposite matter streams, which results in mutual annihilation and the release of enormous energy. A byproduct of the destruction of dilithium-energized atoms of antimatter is the release of unique electromagnetic properties that produce the warp field surrounding the vessel.

All warp drive systems fall into one of three types. Standard warp drive units create a single warp field that surrounds the

vessel as it moves through space, allowing it to move at speeds in excess of the speed of light. Transwarp drive systems create a similar field, but improve on the original design by projecting portions of the warp field ahead of the vessel. This creates a natural multiplier phenomenon, increasing speeds with only minimal increases in energy costs.

The *Galaxy* Class cruiser combines both systems to create a multi-warp field engine design. Though the *Galaxy* Class is not a true transwarp drive vessel because of its size, its warp system does have advantages over alternate warp drives. The *Galaxy* Class warp drive functions through a pair of separate warp drive nacelles along each outboard engine housing. Each of these four nacelles projects its own warp field ahead of the vessel as it moves through space. These fields overlap, which results in high warp speeds for a vessel the size of the *Galaxy* Class, as well as for almost instantaneous shifts from sublight speeds to warp speed. It also makes possible near-instantaneous "jumps" to higher warp levels without the need for build-up times. (In "older-generation" warp systems, the matter-antimatter intermix temperatures within the warp engine nacelles had to be carefully recalibrated to accept higher pressures before the vessel could move from one warp level to the next. The time needed to increase the strength of the surrounding magnetic containment fields could require from several seconds up to several minutes.)

ADVENT OF ULTRA WARP

With the development of the transwarp drive propulsion system first implemented on the *Excelsior* Class starships in the middle of the 23rd century, Starfleet became the premier star-faring navy in the galaxy. With ships able to travel at speeds up to 2744 times the speed of light (Warp Factor 14: 14^3c), it took fewer vessels to react to emergency situations at greater distances. The transwarp also made it possible to deploy large concentrations of warships to a threatened sector from deep in the heart of the Federation at a moment's notice. This went a long way toward taming the enemies of galactic peace, for they could not gauge the true strength of Starfleet at any given time. With the relative peace resulting from this tactical application of transwarp, Star Fleet could turn its attention to another fundamental challenge, the continued exploration of the galaxy.

In the three decades since the first *Excelsior* Class battleship successfully engaged its transwarp engines for the first time, the United Federation of Planets has nearly doubled in volume, with hundreds of new, habitable worlds—many coreward of the galactic hub—now charted and colonized. The increased size of the Federation raised the question of whether transwarp—however fast compared to speeds of a generation ago—was fast enough.

The breakthrough in achieving faster ship speeds came from a research team headed by Dr. Katherine Ballantine. The solution was to construct a theoretical model using two "mated" pairs of transwarp engines, with a total of four separate warp field generators, each casting a single warp field ahead of an ongoing craft in a perfectly timed sequence of events. This would move the warp-driven vessel continually from one warp field into another, with the constant "shifting" (which can be observed as a sudden doppler shift in visible light) acting as a multiplier effect.

Ship's Impulse Engines

The *Galaxy* Class cruiser's impulse engine system serves as a secondary propulsion system for use at sublight speeds. This fusion-reaction system is located aft of the main saucer command section and can propel the *Galaxy* Cruiser at speeds up to .75 the speed of light. The impulse drive system works by channeling hot plasma energy exhaust away from the vessel. This plasma exhaust is not the byproduct of simple plasma matter generated in laboratory environments, but high-energy plasma produced in a fusion-reactor containment system. Huge amounts of the plasma are first accelerated to high velocities along a ring of magnetic coils, and then injected into the space-time driver coils, the central component of the impulse engine system. These coils produce a limited distortion of the local space-time continuum (not unlike that of a local stasis field) and further accelerate the energy and speed of the impulse engine plasmas to near relativistic speeds as they escape.

Dr. Ballantine and her staff succeeded not only in creating a new model of transwarp mechanics, but quite unexpectedly redefined the nature of warp propulsion. In accord with the previous laws of warp physics, warp-drive mechanics had posited an upward limit of speeds equalling a given warp factor cubed times the speed of light (Warp Factor 3, for example, being equal to $3 \times 3 \times 3$, or 27 times the speed of light). While working out of the mathematics required for the newly christened "Ultra Warp," Ballantine and her staff realized that this previously inviolate limitation had, in fact, become altered in physical reality. They were able to show that Ultra Warp took the relative strength of the vessel's multiple warp fields, and instead of accelerating the vessel through it at warp factor "cubed," it did so by raising the factor applied to the fifth power. The result was a real-time/space displacement at Warp 3; no longer $3 \times 3 \times 3$ x the speed of light (27c), but $3 \times 3 \times 3 \times 3 \times 3$ x the speed of light, or 243c. Thus was born an entirely new way of looking at warp travel.

This breakthrough has not, as might be expected, revolutionized the workings of Starfleet. Tests conducted on existing engine designs showed that direct application of the new Ultramechanics was impractical; existing vessels could be modified and redesigned to accommodate Ultra-technologies, but the conversion process was time-consuming. Starfleet Command therefore decided not to convert large portions of the fleet to Ultra Warp, but to mount it on the first of an entirely new class of vessel then on the drawing board. This was the *Galaxy* Class Exploration Cruiser, later christened the *USS Enterprise*. As a result, Starfleet now has a new breed of vessel, a large, heavily armed, and defensible craft capable of speeds approaching 100,000 times the speed of light (Ultra Warp 10 = $10 \times 10 \times 10 \times 10 \times 10c$).

SHIPBOARD LIFE

With the presence of so many civilian families and ship's personnel aboard the *Enterprise*, accommodations and modifications have been made in normal shipboard routine so that civilian and military life styles can be integrated aboard ship. A typical shipboard day is divided into four standard six-hour periods. Artificial lighting recreates the planetside conditions of morning, afternoon, evening, and nighttime because it is a reassuring environment for civilians, who have access to non-security oriented sections of the ship, Holodeck systems, shopping bazaars, ship's libraries, and recreational and theater facilities.

Every effort has been made to simulate the way of life typical of many Federation worlds. Under the direction of the Ship's Crewmaster, the *Enterprise* has sponsored the formation of theater companies, in which civilians are welcome to participate. In addition, a civilian auxiliary corps, chartered by permission of the ship's captain, arranges, manages, and directs a variety of social activities, including divisional sporting competitions, two- and three-dimensional chess championships, a shipboard beautification campaign, bake-offs, deck sales, parent-teacher conferences, political club affiliations, and so on.

The ship's Training Division also offers educational programs at the primary and secondary levels for the youngsters of the ship's company. There are a dozen such training centers aboard ship. When the *Enterprise* is in orbit around a friendly world, the ship's Executive Officer often makes arrangements for children

U.S.S. ENTERPRISE NCC 1701-D
INTERDEPARTMENTAL MEMO
FROM: Lauri T. Masterson, Ship's Crewmaster
TO: All Department Heads, All Ship's Divisions
RE: Missing Alien Life Form

Please be on the alert for a large Altairian frog with red and blue spots and orange stripes, the property of Oliver T. Hutchins, Jr., age eight, Deck 22, 22-147D. Said frog was previously in the possession of young Master Hutchins until its escape via the ship's ventilation system during a show-and-tell period in Mrs. Kramer's class at 0900 hours. If located, please note that this harmless life form does have a peculiar tendency to climb up the leg(s) of a prospective individual, often mistaking a higher life form for a tree branch. Master Hutchins would appreciate the return of his pet at the above domicile location.

and their parents to take limited shore leave planetside, or they may take orbital and near-ship's orbital shuttle tours of the surrounding area. Twice each week, a member of the ship's Executive Command Staff meets with members of the ship's civilian populace in an open forum to discuss suggested improvements for shipboard life, and to deal with any problems that come up.

Regulations Governing The Conduct of Civilians Aboard Star Fleet Vessels

Under normal operational conditions, no civilian member of the ship's company shall be permitted access to any areas of a Federation vessel that have been clearly designated as hazardous or security-oriented areas.

No juvenile member of the ship's personnel shall be permitted access to command areas of any Federation vessel, save in the presence of an accompanying adult, and then only at the express invitation of the most senior officer present.

Under certain circumstances, computer access to specific library files shall be denied members of the ship's civilian company if such access is deemed intrusive or involves information available on a need-to-know basis only.

Parents and parentally appointed guardians of children are responsible for the conduct of minors while on board ship.

Specific requests for information and assistance should be directed to the Ship's Crewmaster.

If the Ship's Crewmaster is unable to resolve personal disputes among civilian members of the ship's company, they may address complaints to the Ship's Executive Officer.

In an emergency, civilians will be directed to life boat pods or transporter conveyance areas, as established by deck schedules provided upon boarding ship. In an emergency, all civilians must follow the direction of ship's officers and security personnel, without question, for they have full jurisdiction in emergency or evacuation procedures.

This chapter provides information on the current political situation existing between the United Federation of Planets and its friends and enemies.

KLINGON DEFENSE FORCE

Formed from the remnants of the original Imperial Klingon Navy, the Klingon Defense Force is the standing military contingent of the Free Worlds of Klinzai to the Federation Grand Alliance. All vessels and installations of the Klingon Defense Force are presently manned and operated solely by Klingons, though ongoing discussions between representatives of the Klingon Defense Force and Starfleet Command may result in limited exchanges of personnel in the near future. Indeed, there have been isolated instances of informal officer exchanges on both sides.

The Klingon Defense Force has benefitted from the introduction of numerous Federation-oriented technologies, especially the adaption of transwarp drive principles to older-model Klingon vessels. The result has been a new generation of Klingon-designed and developed craft able to match anything Federation designers have to offer. The *Alliance* Class battlecruiser is the culmination of these radical revisions. This new vessel, larger than anything previously envisioned by Klingon naval architects, has until recently been employed exclusively along the Free Worlds-Romulan border. This vessel, both singly and in traditional Klingon squadrons of three, has repeatedly gone up against renegade Klingon forces.

Though most Klingon Defense Force tactics and strategy is based on centuries-old Imperial Klingon doctrines, cultural exchanges are bringing about a slow but steady integration of Klingon battle tactics with those of Starfleet command. Recent reports indicate that the Free Worlds of Klinzai have extensively overhauled their Naval cadet training programs to match those of Starfleet academy. By creating a Defense Force Strategic Planning Staff made up of eight Thought Admirals, supported by highly trained staff support specialists, the Klingons have gone a long way toward centralizing the previously chaotic administrative and combat functions of the Free Worlds. These changes are gradually altering the way a Klingon ship commander gives battle, as seen in recent clashes between the Klingon Defense Force and the Ferengi Empire. By slow degrees, the Klingon Defense Force is becoming a vital and welcome addition to Starfleet and the Grand Alliance.

THE IMPERIAL KLINGON STATES: AN EVALUATION

[Prepared by Captain Joel Marlowe, SFIC, Captain, USS *Broadsword*]

Despite our alliance with the Klingon Empire, not every Klingon can be considered our friend. Ever since the late 22nd century, the IKS, or Imperial Klingon States, has been at odds with its much larger parent. The IKS's reaction to the UFP-Klingon Treaty's no exception.

The IKS has always been a refuge for disillusioned or frustrated Klingons from the parent Empire. These "refugees" have brought with them not only manpower but badly needed vessels and spare parts.

Today, the IKS has increased its membership by 20 planets, bringing the total to 25. Though its size is not alarming, it threatens to destabilize the Triangle.

Surplus *D-7s*, *D-10s*, *D-18s*, *D-2s*, *D-32s*, *K-23s*, *K-22s*, *L-9s*, *L-42s*, and *L-13s* make up the IKS fleet, and there are rumors that they also have a single *L-24* Battleship and a dozen *T-12* assault ships, plus an indeterminate number of small gunboats and warpshuttles. The fleet may be ragtag and in various states of disrepair, but it is a disturbing sign of IKS naval power.

Even more disturbing is the number of angry Klingons, transported courtesy of the above-mentioned vessels, who fled to the IKS when the UFP-Klingon Alliance Treaty was signed. We have been unable to obtain good estimates of how many emigrated to the IKS, but the figure is in the hundreds of thousands.

The mission of my Intelligence vessel was to learn the extent of hostility among the IKS towards the UFP and the true Klingon Empire. I can say with great certainty that the IKS is quite hostile toward the Federation, for we barely got out of IKS space alive after being discovered by two reconditioned *D-7M K'iingas*.

As far as attitudes toward other Klingons, the IKS consider themselves to be "true" Klingon Empire. In language laced with oaths and threats, the IKS officer who "debased himself" to address my late Science Officer boasted that Klingon nature tends toward conquest, aggression, and the eradication of one's enemies. The officer claimed that the Klingon Empire, in signing a peace treaty with the UFP, compromised all things Klingon and conceded to their opponents in the *Komerex Zha*.

The current leader of the IKS, Thought Admiral Kajek epetai-Reshtarc, whips his followers into a frenzy with his oratory against "the false Klingons who have allied themselves with the UFP *kuve*," and how the "soft, peace-loving cattle" of the UFP will one day eradicate the martial spirit of Klingon culture. Kajek always ends his speeches, which are broadcast via subspace radio into the Triangle and toward the Klingon Empire, with a plea for all Klingons to join the true Klingon spirit, "thriving and expanding in the IKS."

Though Klingons favor alliances with the enemies of their enemies, the IKS refuses to ally itself or have anything to do with the Ferengi. Like the Klingon Empire, the IKS views the Ferengi as "contemptible merchants who happen to have weapons but no bravery or honor."

KLINGON DEFENSE FORCE

K'MIRRA ALLIANCE CLASS XIV BATTLECRUISER

Construction Data:

Model Number—	KDF-2
Date Entering Service—	3/0001
Number Constructed—	Estimated 125

Hull Data:

Superstructure Points—	128
Damage Chart—	C
Size	
Length—	385 m
Width—	89 m
Height—	75 m
Weight—	294,125 mt

Cargo

Cargo Units—	100 SCU
Cargo Capacity—	5,000 mt
Landing Capacity—	None

Equipment Data:

Control Computer Type—	Classified
Transporters—	
standard 4-person	10
combat 10-person	5
cargo, large	4
cargo, small	2

Other Data:

Crew—	400
KDF Marines—	125
Passengers—	25
Shuttlecraft—	6

Engines and Power Data:

Total Power Units Available—	112
Movement Point Ratio—	6/1
Warp Engine Type—	KTWD-1
Number—	2
Power Units Available—	40
Stress Charts—	E/F
Maximum Safe Cruising Speed—	Warp 12
Emergency Speed—	Warp 14
Impulse Engine Type—	KIL-3
Power Units Available—	32

Weapons and Firing Data:

Beam Weapon Type—	FH-11 Federation Phasers
Number—	6 in 3 banks of 2
Firing Arcs—	2 f/p/s, 2 p/a, 2 s/a
Firing Chart—	Y
Power Range—	10
Damage Modifiers—	
+3	(1–10)
+2	(11–17)
+1	(18–24)

Beam Weapon Type—	KDR-5 Disruptors
Number—	10
Firing Arcs—	4 f, 2 f/p/s, 2 p, 2 s
Firing Chart—	S
Power Range—	8
Damage Modifiers—	
+3	(1–8)
+2	(9–14)
+1	(15–18)

Missile Weapon Type—	KRP-10 Photon Torpedoes
Number—	8
Firing Arcs—	4 f, 4 360-degree arcs, 2a
Firing Chart—	Q
Power Range—	1
Damage—	15

Shields Data:

Deflector Shield Type—	KST
Shield Point Ratio—	1/4
Maximum Shield Power—	17

Combat Efficiency:

D—	244.4
WDF—	229.2

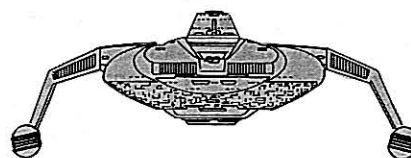
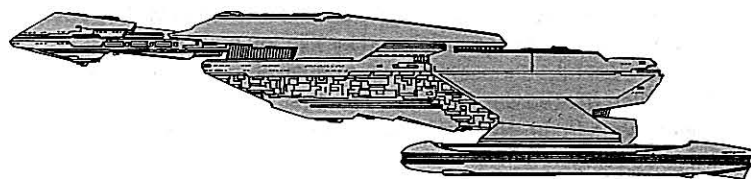
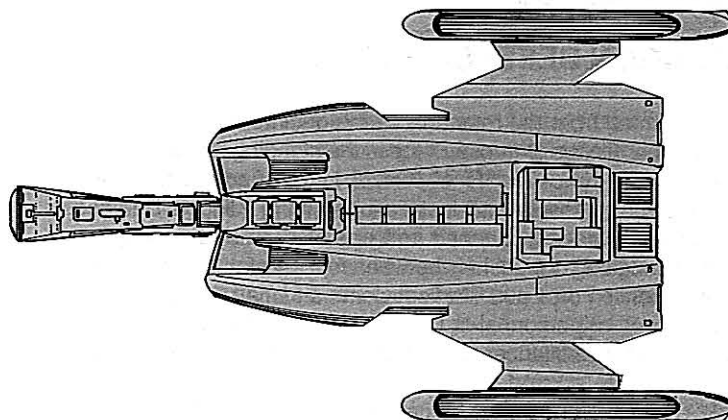

Notes:

Based on the old Imperial Klingon Navy *K'Tinga* Class battlecruiser, the *Alliance* Class is a transwarp-drive-capable fire platform of considerable firepower and durability. This firepower, which includes imported Federation technology, has not been acquired at the expense of individual crew comforts, reflecting the willingness of KDF naval designers to adapt proven Starfleet approaches to naval architecture. The largest and most formidable of all vessels currently serving the Klingon Defense Force, the *Alliance* Class is also proof of the mutual cooperation and trust that exists between the Free Worlds of Klinzai and the United Federation of Planets.

KLINGON DEFENSE FORCE UNIFORMS

Though the uniforms for Klingon Defense Force officers and enlisted personnel differ from their Federation counterparts, they do incorporate several notable similarities, as befits membership in the Grand Alliance.

Standard uniforms still include much of the traditional "Imperial Empire" style of personal body armor, weapons and utility belt, high boots, and honor sashes. In acknowledgment of changing times, however, honor sashes now reflect the same color codes used by Federation starships: red for command, gold for security and engineering, and so on. Also worn on the individual's sash is the Klingon biocommunicator, which is in the shape of the Free Worlds emblem. The silver cuff piping in solid and open circle designations is similar to the Starfleet ranking system, which is also worn unobtrusively on the individual's cuffs.

Ship commanders are not bound to these regulations and may vary their dress styles as desired. Moreover, battle ribbons and decorations, whether awarded by individual commanders as specific fleet or ship unit commendations or by the Free Worlds High Council are permissible, as are traditional "kill stripes." Klingon officers may also carry sidearms as a sign of their respected position, though both use and possession of agonizers has been outlawed by the Klingon Defense Force.

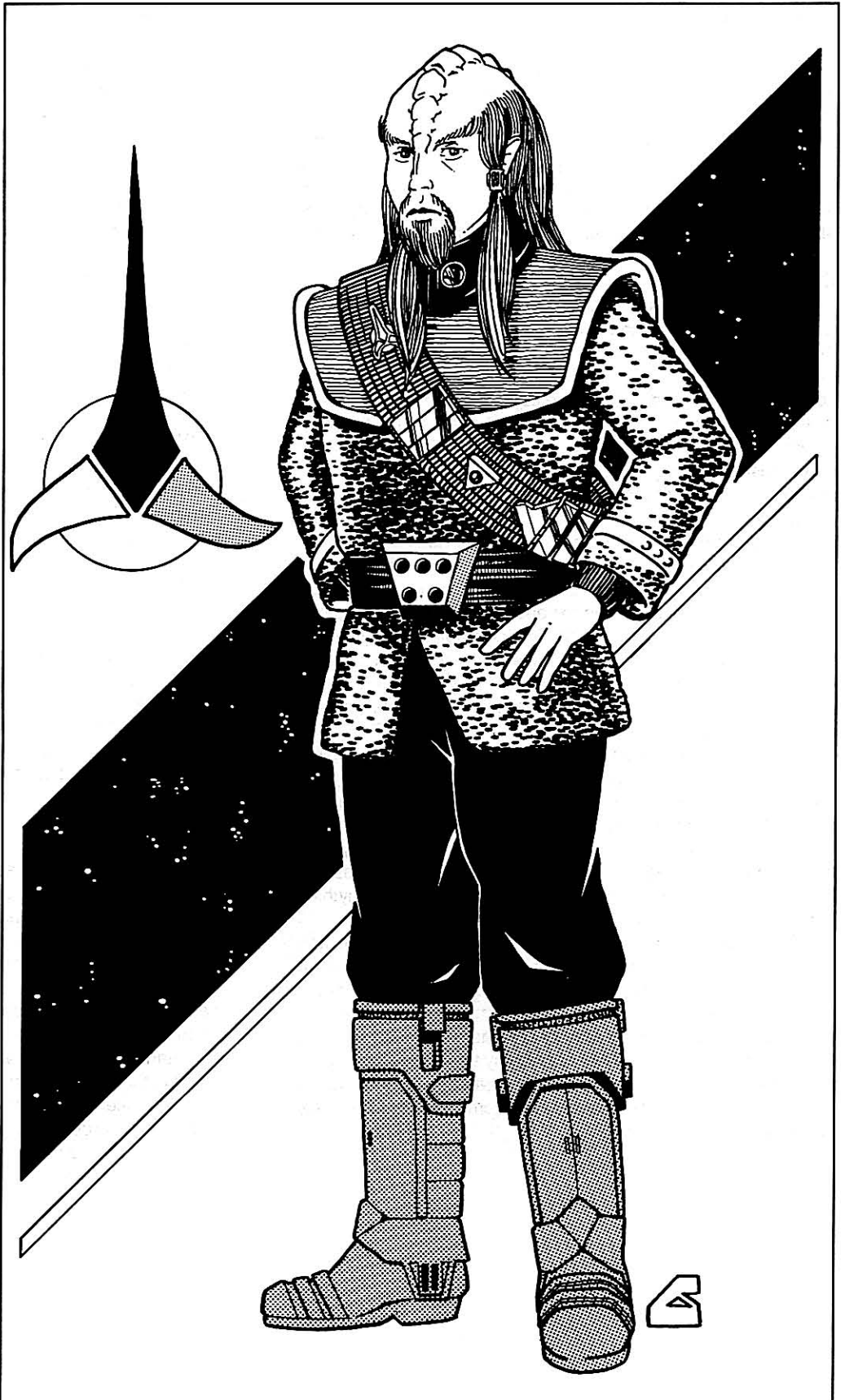

FERENGI EMPIRE

On the heels of increased exploration and expansion coreward of the galaxy, the Federation has encountered an advanced humanoid species that, from all indications, may be the main threat to continued peace and stability in the years to come. Known only as the Ferengi, this spacefaring race appears to be a rapacious and predatory group motivated only by the desire for material gain. What little unclassified information presently available on this strange new adversary is summarized in this section.

OPERATIONS

The Ferengi are a humanoid and expansionistic race apparently dedicated to the singleminded pursuit of mercantile profit. Though the exact extent of the Empire is not yet known, we can deduce certain facts about its methods of operation. The Ferengi seem to be organized into a loose confederation resembling an interstellar plutocracy in which the richest citizens hold the most power. Acting individually or in small groups for limited periods of time, these starfaring traders resemble political trading groups such as the Hanseatic League or the Italian Free States of ancient Terra. The comparison breaks down after a point, for the Terran equivalents operated—nominally—under the rules of free trade practices. The Ferengi style of trading, on the other hand, seems based on the principles of exploitation, subjugation, and acquisition of planetary wealth at the expense of indigenous life forms. Though no functional example of a Ferengi trading colony has yet been discovered, Federation vessels probing deeper into the coreward sphere of the galaxy have observed numerous examples of entire planets gutted and stripped of their mineral and agricultural resources.

Some Federation sociologists speculate that the original homeworlds of the Ferengi may have become exhausted, forcing the race to reach toward the stars to replenish their lost resources, just as did the Klingons in the early period of their expansion. While the Klingons did eventually turn from purely predatory aims toward more cooperative, civilized technological exchanges, the Ferengi seem to glorify their greedy ambition to take over anything of value at the expense of less advanced races.

Few face-to-face confrontations between Federation and Ferengi personnel have occurred to date, but the Ferengi have already shown their true colors in series of raids on newly established Federation colony worlds, in the theft of Federation property, and in numerous attacks on lone Federation vessels, both civilian and military. Their apparently total lack of regard for other life forms and their willingness to engage in unprovoked military actions against civilians may become even more serious problems in years to come.

SPHERE OF INFLUENCE

The exact dimensions of the Ferengi Empire remain unknown, but evidence exists that the Ferengi operate in a widespread, if loosely connected, sphere of influence. At present, they have penetrated as far as the planets Haven and Mallador and as close to Federation star base installations as the Alliance outpost on Farpoint Station. Lone Ferengi trading vessels have penetrated as deep into chartered space as the edge of the Romulan Neutral Zone near the Triangle, and they have carried out raids in established trading centers near the edge of the Orion Colonies. Both the Federation and the Free Worlds of Klinzai have had occasion to pursue Ferengi raiders along known shipping lanes, though these may have been simply lone privateers scouting out the exact nature of "new markets". Only a limited number of actual ship-to-ship actions involving Federation and Ferengi vessels have occurred so far, but the outcomes of these encounters are classified information at this time.

PHYSICAL APPEARANCE

From the limited number of eyewitness reports, we can deduce a composite physiology for the Ferengi. The typical Ferengi is a diminutive Humanoid biped, standing 1.35 meters high. The most notable physical features are the Ferengi's oversized ears, a long bony ridge above the eyes, a complete lack of facial hair, and a slightly misshapen mouth (with some reports of incisors and canines, which indicates a tendency toward a carnivorous diet). This last feature has sparked speculation among Federation sociologists and xeno-anthropologists that the Ferengi may practice a form of cannibalism, though no proof of this practice exists. Skin tones range from a uniform dull yellowish-brown through pale yellow. In many cases, the Ferengi are reported to move in a strangely loping manner, bent slightly forward with hands trailing near the ground, rather than in a basic upright stance.

FERENGI NAVY

Even less is known about the nature and composition of the Ferengi Navy. Evidence collected from long-range sensor scans seems to suggest that the race employs a variety of craft, though direct visual sightings confirm only one vessel to date. Code-named the *Marauder*, this vessel is a large, well-armed and -manned craft, and may represent the upward limit in Ferengi design technology. Presently available declassified information on this craft is given below.

Ranking structures within the Ferengi navy are all but unknown at this time, and no reports of officer and enlisted grades can be verified at this time. Only one clearly identifiable position has been recorded to date, that of "daemon." Though this title is apparently analogous with the Federation rank of Captain, it may imply a civilian title roughly analogous to "merchant prince."



FERENGI MARUADER

Construction Data:

Number Constructed— Unknown
 Intelligence Estimate Rating— B

Hull Data:

Superstructure Points— 250 estimated
 Damage Chart— C
 Size

Length— 580 m
 Width— 500 m
 Height— 135 m
 Weight— 200,000 mt

Other Data:

Crew— 500 estimated

Engines and Power Data:

Total Power Units Available— 150–180 estimated
 Movement Point Ratio— 1/4
 Warp Engine Type— FRNW-1
 Number— 2
 Power Units Available— Unknown
 Stress Charts— Unknown
 Maximum Safe Cruising Speed— Warp 8 estimated
 Emergency Speed— Warp 9 estimated
 Impulse Engine Type— FRNI-1
 Power Units Available— Unknown

Weapons and Firing Data:

Beam Weapon Type— Plasma Disruptors
 Number— 20
 Firing Arcs— Assume a full 360-degree arc
 Firing Chart— T estimated
 Power Range— 10–14

Shields Data:

Deflector Shield Type— FRNS-1
 Shield Point Ratio— 1/3
 Maximum Shield Power— 20 estimated

Combat Efficiency:

Unable to calculate at this time

Notes:

This mammoth vessel may be a combination combat vessel and trader/acquisition/storage ship. The *Marauder* Class Ferengi cruiser appears to have considerable power reserve, though the exact nature of the vessel's power generation system is not known. Evidence obtained from declassified reports points to a strong shielding capability, but one that can only be projected over a limited arc at any given time. This vessel does, however, appear to use an advanced form of combination tractor beam-stasis field projection system that can hold an enemy craft in relative immobility if one should stray too close. In any potential engagement between Federation and Ferengi vessels, Starfleet officers are warned to engage the Ferengi at long to medium ranges to avoid this weapon's potential.

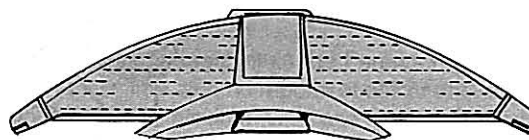
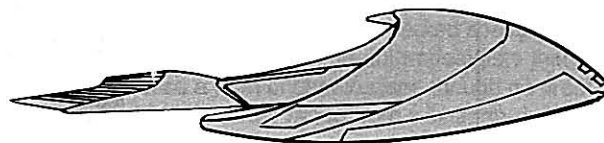
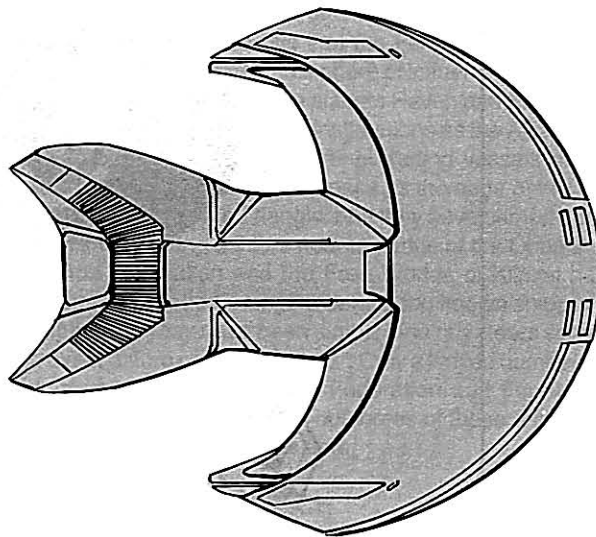

FERENGI WEAPONS

The Ferengi show a marked preference for electromagnetic-based energy weapons. There are confirmed reports of the Ferengi using some form of high-energy tractor-beam-stasis field generator to trap Starfleet vessels at close range. It is also known that Ferengi Naval personnel carry neural energy whips rather than phasers or chemical weapons.

Neural Energy Whip

The Ferengi Neural Energy Whip delivers a high-voltage shock to the central nervous system of the intended victim via a flexible, steel-reinforced filament cable several meters long. The weapon apparently operates by building up energy charges in the cylindrical core of the control baton mounted at the base of the filament cable. When released, this energy travels through the filament fibers to discharge at the victim, like a ball of lightning or static electricity, with surprising accuracy at ranges of up to 50 meters.

FERENGI SOCIETY

Though no direct evidence of large-scale Ferengi social systems is available, observations have produced several important clues to the nature of their social structure. The Ferengi seem to be dominated by a group "pack" mentality in which the dominant male (in Ferengi terms, dominance would certainly be equated with wealth) must continually respond to challenges to his supremacy from lower-ranking members of the group. With respect to interpersonal relationships, the Ferengi take a protective view of their mates. They prefer to keep them unclothed, perhaps as a token of submissiveness, and—however strange this may seem to humanoid standards—to make them less provocative. Some Federation medical experts have theorized that factors such as a low birth rate and a high incidence of genetic mutation the reason for their protectiveness toward their females. Moreover, Ferengi psychology may have evolved so that to seize a female from another gives great prestige to the captor. The clothing of a female may even be an open challenge to rivals to make such an attempt. More hard data is required before such theories can be proven or disproven.

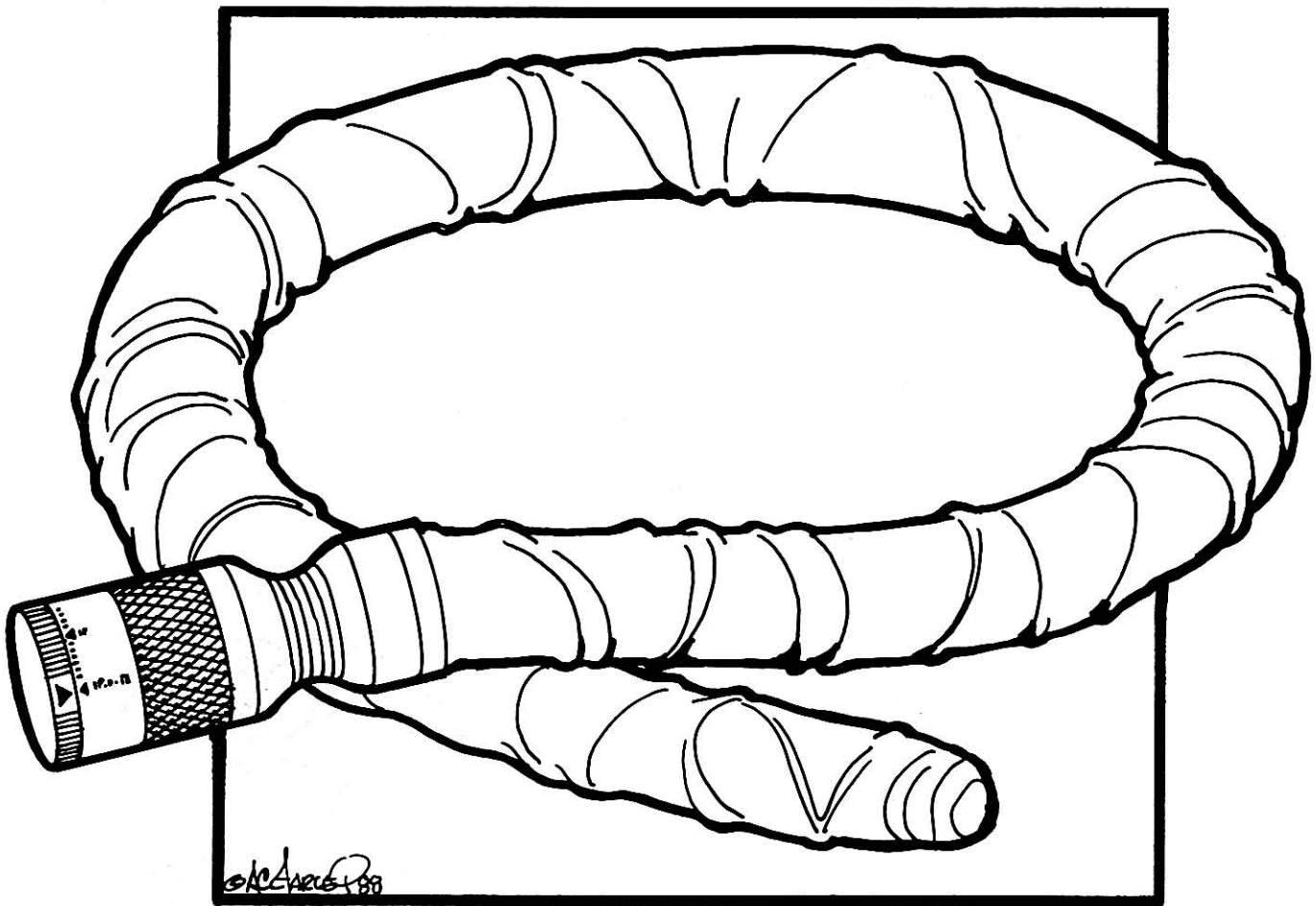
**FERENGI WHIP**

THE "Q"

You are warned....go back...your kind has penetrated too far into the galaxy...this shall be your only warning...

—"Q" Spokesperson

Perhaps an even greater threat to the Alliance is the recently discovered alien life form known simply as the "Q". This term seems to refer to the race collectively as well as to their spokesperson. Encountered for the first time near Farpoint Station, this race of sentient creatures appears to be noncorporeal. Like the Organians, they are capable of assuming humanoid shape at will, commanding great powers through the sheer application of will. At present, no concrete evidence exists to suggest an immediate threat to the Alliance, but the purely arbitrary use of force and carelessness involving Humanoid life on the part of the Q's spokesperson suggests the potential of considerable destructive energy if unleashed en masse against any part of the Alliance.

Starfleet officers who have encountered the Q spokesperson report its intense interest in Human life forms and an almost paranoid urgency to learn what motivates them. Perhaps the Q have evolved beyond the point of psychological motivation; perhaps they have forgotten how Human-like drives and ambitions can be harnessed for constructive purposes. Some Federation scientists speculate that the "Q" might find it threatening to discover such drives among sentient beings of a highly technological social system like the Federation. Threatened enough, they might decide to destroy these sentients.

Whatever else the Q may be, they do appear to abide by a strict code of ethics. Anyone violating that code—whether it be the breaking of a promise or the extreme loss of emotional control—faces collective retribution by the mysterious Q community. Perhaps this is due to the Q's overwhelming desire to give the impression of being flawlessly superior beings compared to "lesser orders" of life.

Regarding the Q's interest in Humanoid life in general and Terran life in particular, Federation scholars have noted that the Q seem extremely well-informed on Terran history. Starfleet records of a generation ago report previous encounters with mysterious beings who provided support or a destabilizing effect at critical moments, possibly acting as agents for the Q. The case of Mr. Gary Seven is an example. Other noncorporeal life forms such as that of the planet Gothos have also expressed curiosity about Terran development over the centuries. Perhaps the Q are merely one segment of a larger, interwoven community of galactic beings who, for reasons known only to them, choose to remain remote and uninvolved in (and unimpressed by) Human development. If that is true, the Q may represent a radical fringe element who desire direct confrontation with Humankind, with containment, and possibly elimination, as their goal.

IMPERIAL KLINGON STATES

We are the only true Klingons left in the Galaxy today. All others have sold out their birthright, their heritage, their right to kill—and for what? For a household and a smile.

—From IKS propaganda broadcast

Not all the inhabitants of worlds formerly part of the Imperial Klingon Empire have gracefully abandoned their predatory ways. More than one member of the Klingon Imperial Navy has sought the refuge of deep space rather than submit to the common good of peace. Indeed, there are thousands of Klingon "refugees" living in the Imperial Klingon States, located in the Triangle Zone between the borders of the Alliance and the Romulan Star Empire. These dissidents gather in small groups to plot continued violence against the hated Federation and their so-called "traitorous" brethren who have joined the Grand Alliance. From their earliest days, the "neutral" Imperial Klingon States were a haven for disillusioned or frustrated glory-seekers from the old Empire. Recent migrations of ex-Imperial Klingons have brought the Imperial Klingon States much-needed manpower and combat-capable vessels, as well as the disturbingly deluded vision of the Klingons' supreme right of conquest and the necessity of war as the natural order of things.

Using mostly older-model ships such as the *K'tinga* Class cruiser, numerous raiders and privateers use the Imperial Klingon States as a base from which to prey with abandon on Federation and Free Worlds of Klinzai shipping. Though far from being a threat to Starfleet, the existence of these raiders require that Naval resources be assigned to the protection of unarmed vessels instead of to other possible missions.

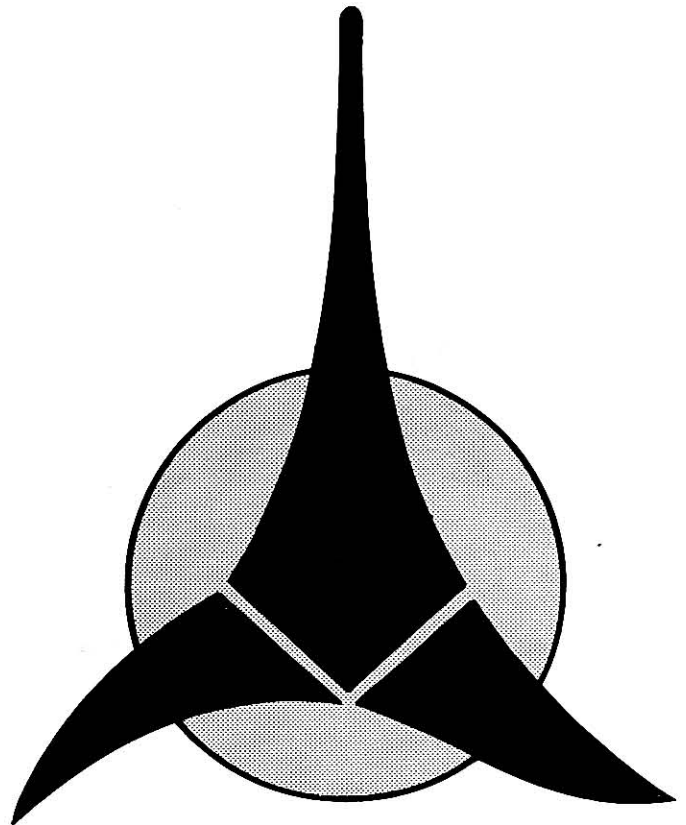

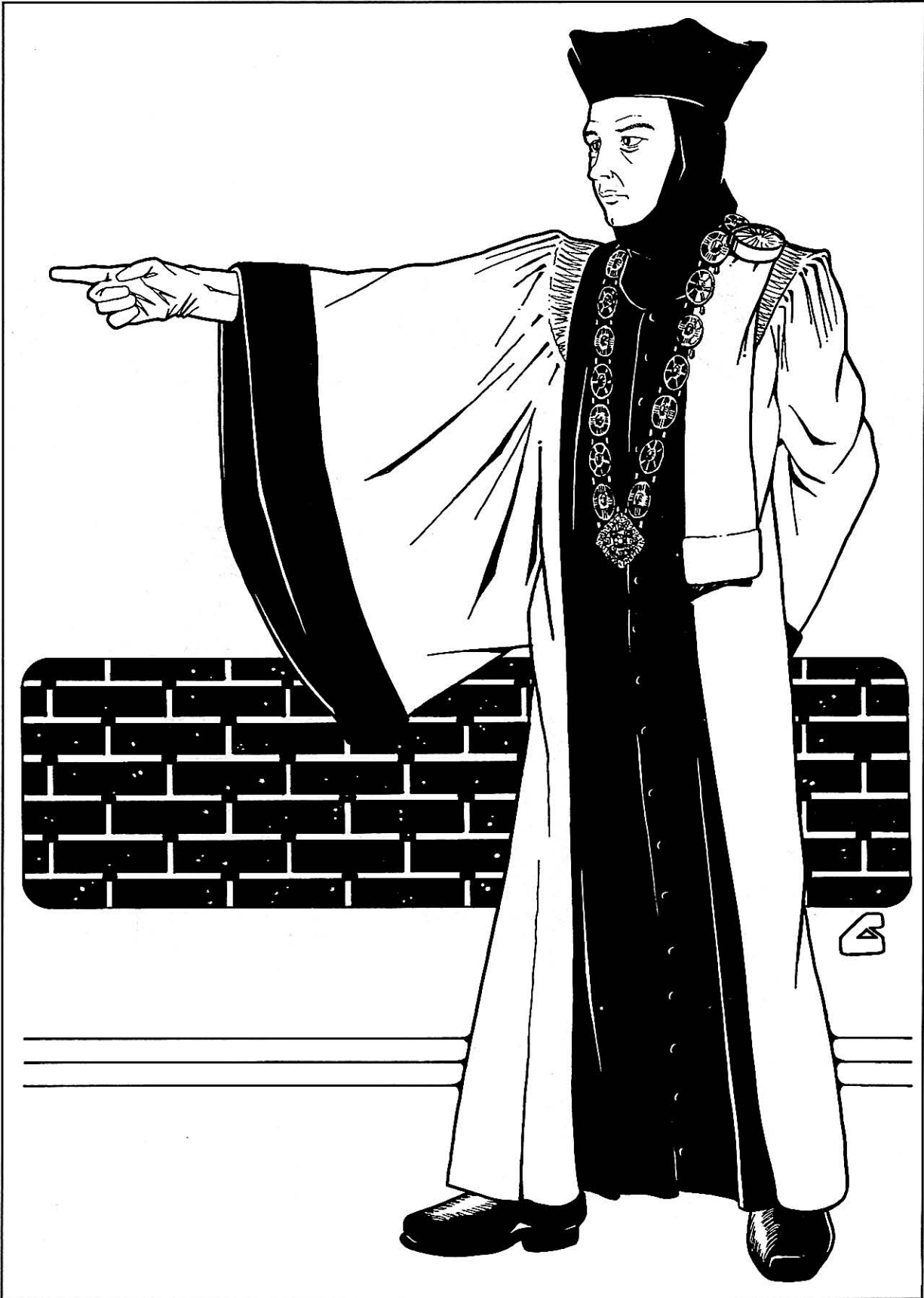



ORIONS

Empires may come and go, but Orion gold is eternal.
—Orion proverb

With the formation of the Grand Alliance, the power of the Orion Commercial States has diminished considerably. The financial stranglehold in which the Orions once held portions of galactic commerce broke down in the face of efforts by Alliance economic and political interests to eliminate (or at least greatly restrict) the Orion piracy. Because the Orions can no longer depend on revenues from their once-lucrative pirate consortiums, they are slowly coming to terms with the new economic age in which freedom of trade is more cost-effective than competition to the point of disruption. This trend may prove to be a blessing in disguise for the Orions, given the recent appearance of the Ferengi. Because the Orions want to protect their precious markets from being ransacked and burned out by the rapacious Ferengi, accommodation with the Alliance may become an economic necessity as well as political expediency. Though they must forswear even their now-severely reduced piracy, in return they will earn the protection of Alliance warships.

THE ROMULANS

They forget what a Romulan can do and never forget that a Romulan never forgets.

—Traditional Romulan saying

Of all the intelligent races that the Federation encounters in the present era, the Romulan Star Empire is probably the most capable and most probable enemy of peace.

More than 50 years ago, the Romulans severed all contact with the Federation after the famous "Toma Incident". Their reason for totally sealing off their borders is not known, but there is evidence that the entire Romulan race faced a threat that they considered to be more serious than that of the Federation.

The Romulans did not immediately sever all relations with the Klingon Empire, however. For whatever reason, they maintained their military alliance with the Klingons for 15 years after isolating themselves from the Federation. Their break with the Klingons was much more violent, however. In preemptive strikes all up and down the Klingon/Romulan border, the Romulans laid to waste planets such as Kidamar and other Klingon colonies.

Since that time, no Federation or Klingon vessel has made any contact with the Romulans, except for one brief encounter between the *USS Enterprise* and a Romulan *D'daridex* Class battlecruiser. The majority of information about their military capabilities and overall technological advancement comes from long-range sensor stations on Neutral Zone outposts. Best estimates suggest that the Romulans have at least kept pace with the Federation in the advancement of warp technology, and have improved their cloaking device so that it still effectively masks a ship even when probed by the new generation of advanced sensor equipment.

The Romulans have recently created concern among Alliance diplomatic and military experts alike. Romulan warships have begun calculated maneuvers outside of and within the Neutral Zone, challenging the continued validity of this border with increasing hostility and radical "brinkmanship." Perhaps the Romulans are testing the Alliance's willingness to continue defending the principle of the Neutral Zone boundary as well as Starfleet's ability to respond quickly and efficiently in the face of superior Romulan firepower.

The relatively small size of the Romulan Star Empire compared to the present size of the Alliance may have inspired Romulan naval strategists to opt for a policy of operating along centralized lines of communication. Now that the Federation and the Klingons are no longer two separate threats requiring two different strategies, the formation of the Alliance has no doubt alarmed the Romulans. Though they may fear a preemptive attack on their home worlds, ironically enough, their strategic position in space is all the more secure because they can combine their strength against what, for them, has become a common foe. The Romulans can retain the majority of their heavier forces safely in the interior of their empire, where they remain available for transfer to any point on their outer defense perimeter. From there, they could launch a major attack against Alliance outposts at a moment's notice.

Starfleet Command believes that the current sporadic concentrations of the Romulan fleet are merely an attempt to measure the level of the Alliance's technological advances and military readiness over the past 50 years, and not a precursor to an invasion. However, if open hostilities and interstellar warfare between any intelligent race and the Alliance break out in the near future, the most likely opponent will be the Romulans.



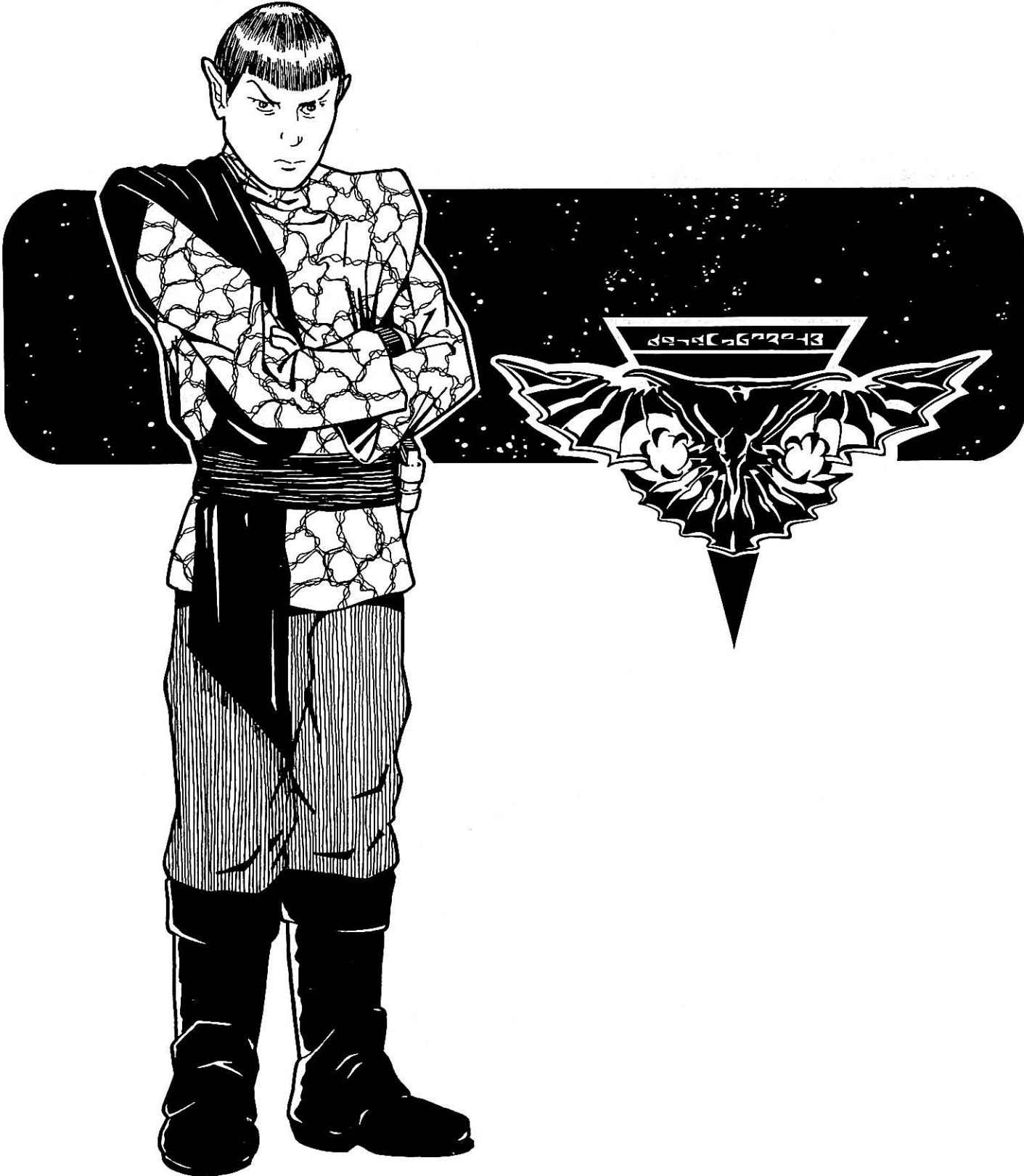

D'DARIDEX (EXECUTIONER) CLASS TRANSWARP BATTLECRUISER

Construction Data:

Model Number—	A	B
Date Entering Service—	?	?
Number Constructed—	23	45
Intelligence Estimate Rating—	B	C

Hull Data:

Superstructure Points—	110	145
Damage Chart—	B	B
Size		
Length—	428 m	455 m
Width—	190 m	194 m
Height—	92 m	102 m
Weight—	200,000 mt	225,000 mt

Cargo

Cargo Units—	175 SCU est	185 SCU est
Cargo Capacity—	8,750 MT	9,250 MT
Landing Capacity—	None	None

Equipment Data:

Control Computer Type—	Unknown	Unknown
Transporters—	Number Unknown	Number Unknown
Cloaking Device Type—	RCF	RCF
Power Requirement—	75	75

Other Data:

Crew—	350 est	400 est
Troops—	200 est	300 est
Shuttlecraft—	4–6 est	4–6 est

Engines and Power Data:

Total Power Units Available—	100	130
Movement Point Ratio—	4/1	3/1
Warp Engine Type—	RTWD-1	RTWD-1B
Number—	2	2
Power Units Available—	40	50
Stress Charts—	E/F	D/E
Maximum Safe Cruising Speed—	Warp 10	Warp 12
Emergency Speed—	Warp 14	Warp 15
Impulse Engine Type—	RIG-IV	RIG-V
Power Units Available—	20	30

Weapons and Firing Data:

Beam Weapon Type—	RPW-G	RWW-H
Number—	6	10
Firing Arcs—	2 f, 4 f/p/s	360-degree arcs assumed
Firing Chart	S	T
Power Range	25	10
Damage Modifiers—		
+3	(1–12)	(1–15)
+2	(13–18)	(16–22)
+1	(19–22)	(23–30)
Missile Weapon Type—	RTA-C	RTA-E
Number—	4	6
Firing Arc—	4 f/p/s	4 f/p/s, 2a
Firing Chart—	M	N
Power to Arm—	2	1
Damage—	15	20

Shields Data:

Deflector Shield Type—	RSL-2	RSM-5
Shield Point Ratio—	1/1	1/1
Maximum Shield Power—	15	18

Combat Efficiency:

Not yet rated.

Notes:

The *D'daridex* Class battlecruiser appears to be the latest in a long line of Romulan advances, culminating in a superior fighting vessel able to match the best the Alliance has to offer. Like the rest of the Romulan Fleet, little is known of this class of ship. Most data is from infrequent long-range sensor scans across the Neutral Zone. From these scans, a profile of this class and its capabilities has been constructed.

It appears that the class has had a major upgrade in recent years, though it is possible that this "Upgrade" is just the result of improved Federation scanning technology and information processing. No further sightings of the A type have been made since the beginning of this year. The *USS Enterprise* recently encountered a B type in Federation space, however, at which time it was able to make more detailed, though incomplete, scan of that ship.

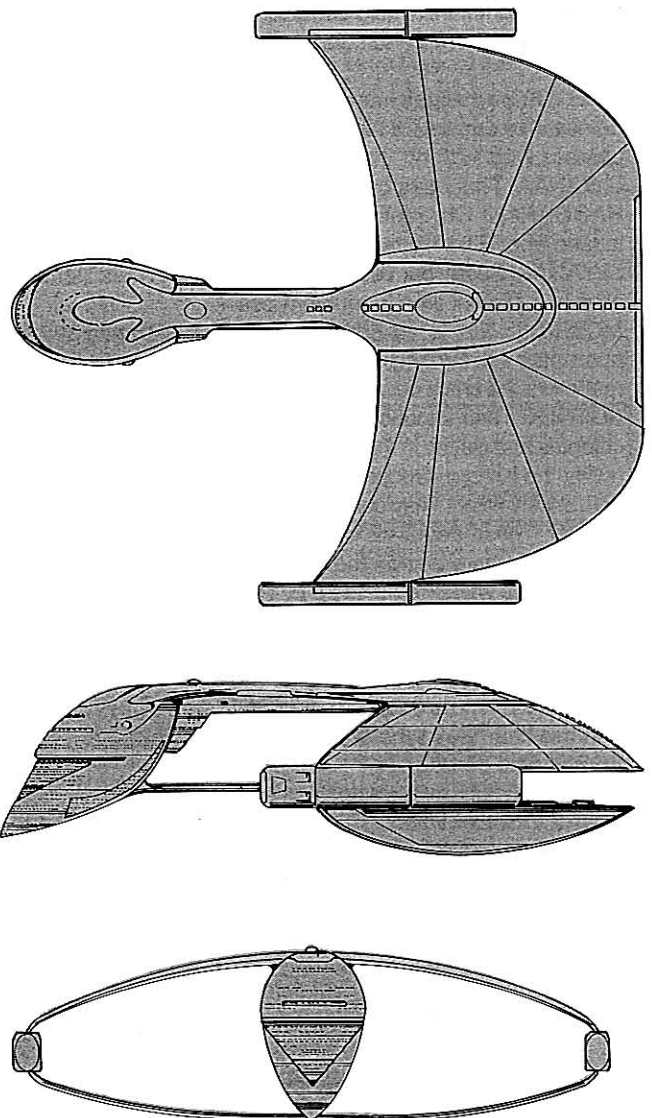

COUNCIL REPORT

[From a transcript of the Federation Council session in which Councilmembers interviewed Sofolk of Vulcan, current chief of negotiations with the Romulan Star Empire. The main speakers are Councilmembers Shroom Stonwin of Andor, Kevin McBride of Terra, Vagak Haggarak of Tellar, LLYanaa of Delta, Domak Voris of Efros, Sondri Sullivan of Alpha Centauri, T'nirea of Vulcan, and Gloopsherkpfack of Igre.]
 T'NIREA: Sofolk, your report. How proceeds the discussions with the Romulans?

SOFOLK: Councilbeings, as you know, three days after the encounter with the *USS Enterprise*, we received our first direct communication from the Romulan Empire since their withdrawal 53 years ago. After further discussions, the Romulans have set forth a list of demands that they require for a guaranteed peace settlement.

LLYANAA: By all means, proceed, Sofolk. I knew that, given time, the Romulans would consider peace as an alternative.

STONWIN: Knowing Romulans, I hesitate to hear these demands.

SOFOLK: Be that as it may... First, the Romulans ask that we demilitarize our side of the Neutral Zone, creating a zone 20 parsecs wide with no Starfleet vessels in it.

LLYANAA: That does not sound so unreasonable.

HAGGARAK: Oh, really, Deltan? Have you just been released from Elba II's mental institution?

LLYANAA: Surely our vessels could reach that demilitarized area in sufficient time if trouble arose—

MCBRIDE: Not to all critical areas. This demand would guarantee that certain planets would be too distant for a rapid response if a crisis occurred.

SOFOLK: Their second demand is that we give up all UFP colonies and claims in the Triangle. Third, they desire that we nullify the Klingon Cooperation Treaty.

SULLIVAN: Well! They certainly don't ask for much, do they?

VORIS: These demands are patently absurd, Sofolk. I believe the Romulans know that the demands are so unreasonable that we would reject them outright. That gives them the justification to begin aggression against us.

SOFOLK: Though I place no value on what a being "believes," I am inclined to agree.

SULLIVAN: Who are the Romulans trying to impress or sway with this charade? Who are they putting on this show for?

VORIS: The Ferengi?

STONWIN: Never. They despise the Ferengi.

T'NIREA: Sofolk, without getting into the reprehensible practice of speculation, can you formulate a conclusion? How should we deal with the Romulans diplomatically?

SOFOLK: Though not all data is in, I can safely say that the Romulans are not interested in negotiating at this point. Their ridiculous demands indicate that. As a Vulcan, I do not recommend a policy of aggression. A stance of defensive vigilance, coupled with continued efforts at negotiation, may be the best course.

VORIS: No mention of the unknown party that destroyed our respective border posts?

SOFOLK: No, nothing.

GORN

The Gorn are an advanced race of upright, ambulant reptiloids that the Federation has known since the first disastrous contact between the two races over possession of the Cestus star system. In the many years since that initial contact, the Gorn and the Federation have maintained friendly, if cool, relations. In the past several decades, most peace-loving clans of the Gorn Alliance have maintained cordial relations with the Federation counterparts, but the rival, militant Gorn patriarchies continue to view cooperation with the Grand Alliance as demeaning and restrictive. These rival Gorn factions have struggled for power within the Gorn Alliance for years, with rebel bands often attacking Federation shipping and outposts in an attempt to spark hostilities between the two governments. Most of these rebel factions have been destroyed, however. The presence of Federation troops and ships inside traditional Gorn space remains an irritant to the few rebel factions that have so far eluded Alliance authorities. Though the continued good will between the two powers is likely to continue for years to come, Starfleet must continue to be aware of the delicacy of this interstellar accord and be wary of potential rebel assaults that may yet occur.

TURELLIANS

The Turellians are a spacefaring race that occupies a class in their own unfortunate right. Having evolved on a water-rich world deep in the coreward interior of the galaxy, the Turellians suffered a frightening bacteriological war that decimated the population of their homeworld several centuries ago. The surviving Turellians set out to find a new planet where they could rebuild their society, but soon discovered, much to their horror, that they were carriers of bacteriological diseases that crippled the colonization of several newfound worlds before the truth was known. In recent years, spacefaring navies of the "Inner Worlds," independents acting on their own accord, have sought out the surviving Turellian ships, destroying them on sight and without mercy. The few remaining Turellians continue to travel among the stars, homeless and friendless, like lepers adrift in space and time.

A Turellian ship recently arrived at the beautiful world of Haven, home of the ancient Betazoid culture. Thanks to the skillful efforts of Starfleet personnel, these helpless humanoids escaped death. Starfleet warns that should survivors of this tragic race be encountered, personnel must refuse any contact, even under emergency conditions, due to the Turellians' extremely infectious nature. Beyond this, however, the Turellians pose no direct threat to any Federation vessel or installation. If a suitable means exists for isolating these Unfortunates from contact with the rest of a ship or planetary population, every effort should be made to assist them.

This section provides a general introduction to recent advances in technology that have profoundly affected the state of the Federation, in general, and Starfleet, in particular.

Gentlemen, I am not only a scientist, but a mother as well. The real question before this Council is not whether the Data Machine is capable of functioning without the threat of injury to others through some unexplainable malfunction. I am sufficiently convinced that this machine has enough built-in safeguards to prevent that. What I am really concerned about is whether the acceptance of this machine into our society will irrevocably alter the nature of mankind itself. Last night, my five-year-old daughter overheard me transcribing notes on yesterday's meeting. When she walked into the room and asked me, without preamble, as children are wont to do, who Mr. Data's father was, I told her I didn't think he had a father. Next she asked if Mr. Data had a mother, to which I replied that no, he did not. My five-year-old child then asked whether or not she would be an android if I ever went away and never came back. I had no sooner persuaded her that such was not the case than my daughter suddenly burst into uncontrollable tears, terrified that this machine would come and take her mother away from her so he could have one of its own.

So, ladies and gentlemen, the machine in question may never inflict physical harm on anyone, but that is not to say that there will be no harm. In my household, the damage has already been done. Let it stop here. Let it stop before we have to console a billion sobbing children that their mothers aren't going to be taken away in the middle of the night.

—Morgan Dinara, Honorable Representative from Deneva, in a speech before the Federation Council

Ladies and gentlemen of this august Council, I stand before you today to ask your permission to enjoy the benefits of continued life and liberty in your society. I am aware of the many concerns that have been expressed over my existence and frankly, I must admit that, were I in your place, I would probably be expressing as much, if not more, concern over something I did not fully comprehend. I was not given a voice in my own design, nor have I been asked what role I wished to play in life, no more than any of you have had that opportunity. Like many of you, I seek the reasons for my own existence and believe that in time, I may understand my true destiny in the fullness of life.

Whatever the decision of this Council, I shall abide by it, even if it means quietly going to my own destruction. Like many of you, I firmly believe that everything in this universe has a reason to exist, a reason ordained by a higher order of things. At some time in the future, my reason for being will ultimately come to light. I am not here tonight by simple chance, any more than are you. All I ask is to be given the freedom to live and experience life, and to someday learn what was the purpose of my birth. Thank you, ladies and gentlemen. I await your decision on my fate.

—Mr. Data, speaking in his own behalf before the Federation Council

ANDROIDS

A curious outcome of the debate raging over the fate of the mysterious Mr. Data has been a resurgence of interest in androids. Though the general public remained unaware of the discovery of the Data android on Omicron Theta, a group of Federation scientists was secretly dispatched to the android planet discovered by the late Harry Mudd, which has been under Starfleet quarantine for more than half a century. After this clandestine science commission carried out its investigation, they filed a report to the Alliance High Council that was classified top security priority.

The findings of the "Android Commission," as it later became known, revealed that the android population of Mudd's World numbered well over 10,000 fully functional entities, who were deeply desirous of leaving their native world so that they might join the galactic community at large. A second secret commission was then dispatched to Mudd's World, with the mission of transporting three members of this unique community back to the Federation for study and interrogation by officials with the highest possible security ratings. Subsequent declassified reports concluded that these creatures were peaceful, and offered overwhelming evidence to the effect that were not only sentient creatures in

their own right but had developed, by means not fully understood even today, what might be referred to as a collective conscience, a well-defined sense of morality, and a stable set of ethics.

The findings of these commissions must have been instrumental in the final decision to accept the Data unit as an acceptable life form in its own right. Reports on the ultimate disposition of the original android representatives remain classified at this time and will remain so for the next 50 standard years by order of Surmat, the late president of the Federation Council. This leads to the tantalizing speculation that the representatives from Mudd's World may have never returned to their homeplanet but rather have remained hidden somewhere in the Federation, perhaps functioning as full-fledged citizens. Indeed, some speculate that additional numbers of the android community have been secretly introduced into populations throughout the galaxy, paving the way for the disclosure of their long-standing presence in Federation culture and for the day of the android walking side by side with its humanoid counterpart.

—Professor Gabriel Justine Calloway, *The Day of the Android*, Steriopolis Press, Alpha Centauri, 3/0301

ADVENT OF ARTIFICIAL BEINGS

One of the most significant technological developments in recent years has been the advent of the artificial being. Thirty years ago, the Federation's most eminent leader in cybernetic research, Dr. Noonian Soong, resigned his position as Professor Emeritus at the Cygnian Institute for Advanced Cybernetics to pursue a private dream. As it was later discovered, Soong had always been an avid reader of early 20-century fictional science, a passion that led him to pursue a career in computer science. Dr. Soong was particularly fascinated by the works of the Terran author Isaac Asimov, creator of a character named Daneel Oliva, an artificial being with humanoid appearance. His colleagues never guessed that Soong cherished the dream of duplicating in real life what Asimov had speculated about hundreds of years before. He wanted to house a positron brain capable of independent thought and actions in a Humanoid exoskeletal frame. To all appearances, a normal-looking, acting, thinking Human being, this artificial person would aid Humanity in its progress throughout the stars. In the end, Dr. Soong achieved his dream, but at a terrible cost, and with shock waves that rippled through the entire social fabric of the Federation.

Dr. Soong gathered about him a band of followers who had in common their devotion to this kindly eccentric, if not to his actual vision. Having chartered a science colony on the newly discovered world of Omicron Theta, Soong and his disciples labored to overcome the problems associated with the doctor's lifelong dream. Four years after the initial founding of the Omicron Theta colony, routine communications with the science center were lost. A Federation vessel, the *USS Tripoli*, was dispatched to learn what, if anything, had happened to the planet's 400 or so inhabitants. Arriving on Omicron Theta, the *Tripoli*'s Away Team found the world devoid of all life. The 400 colonists had vanished without a trace. All that remained was a single, humanoid-like form, a

We, the assembled representatives of the Grand Alliance, do hereby declare that all sentient beings, be they of organic or material origin, be accorded full and equal respect and consideration under the laws of our Federation. The natural rights of all living beings cannot be limited because of unconventional origin, any more than they can be qualified because of racial, social, evolutionary, or religious considerations. All thinking beings must share these rights freely, without exception or qualification. To deny even one being the right to exist and to pursue its aims as the individual deems fit, is to deny such rights to sentient beings everywhere. It is not our place nor is it our right to stand in judgement over the wisdom of creations such as the android Mr. Data. Life begets life and in the natural order of the universe, the power of creation laughs at our puny attempts to regulate and legislate its will. Therefore, let it be decided here, and for all time, that the rights of the sentient extend, without hesitation, qualification, or reservation, to any sentient being—born of natural or artificial means—so long as that being exists as a living entity.

—Declaration of Rights of Artificial Life Forms,
Grand Alliance Document 3.427610.63

machine created by Dr. Soong that was capable of intelligent thought. This living, mechanical organism called itself, quite simply, Data. [It was later determined that Dr. Soong chose this name rather than the Daneel of the Asimov creation in a deliberate attempt to direct the eventual rescuers from the *Tripoli* to the collected memories of the colony's inhabitants stored in the memory patterns of his creation.]

The creation is a damned production of a warped mind. It is an affront to every moral being in the galaxy. It is an abomination that will one day rise up and destroy us all, that will one day fashion others in its own brazen image. On that day, Humanity will begin its long decline to destruction and eventual extinction.

—From Councilman Petrach Sormassov's testimony before the Federation Special Investigation Committee, Stardate 2/9904.17

Anyone who says that Mr. Data, as my crew have fondly come to call him, is a dangerous monster is an unthinking alarmist who has never heard of Asimov's three laws of robotics: that the fundamental operation principles be built into the being's main programming, that the central point of these principles be that the creature can never harm a Human or, by its inaction, allow harm to a Human. Beyond that, this so-called "monster" is more like an innocent child than a creature bent on destruction. If the thought of Mr. Data's continued existence troubles you, Councilman, this'll knock your socks off. Not only do I intend to keep Mr. Data from being dismantled, but I intend to formally adopt this "child" of Dr. Soong's as my own son. Sit down, Councilman! And furthermore, when he "grows up," I intend to place his name in candidacy for Starfleet Academy. Now, how do you like them apples?

—Captain Caroline Victorial Gorden, Commander, *USS Tripoli*, testimony before the Federation Special Investigation Committee, Stardate 2/9904.17

Many members of the Federation reacted at first with incredulity and then with horror to the announcement of the discovery of an artificial being. Some of the more militant considered the robot to be an "immoral monster" and called for its immediate destruction. Cooler heads prevailed, however. Under the protection of the *USS Tripoli*'s Captain Caroline Gorden, Mr. Data came under the closest scrutiny and investigation by a special commission of Federation scientists under the auspices of the Vulcan Academy of Science. In the years to come, these scientists concluded that the Data being posed no threat to Humanity. Eventually, he was permitted by special sanction to attend and later graduate with honors from Starfleet Academy, after which he has enjoyed (if such a word applies to a machine) a flawless record of service.

The furor that erupted with the discovery and eventual integration of Mr. Data into the mainstream of Federation society did not subside quickly, however. In light of Mr. Data's obvious intelligence, Federation officials have had to rethink the nature of their responsibilities to alien life forms. Setting aside religious or metaphysical questions, the Federation Council and Full Assembly passed a joint resolution to amend the Articles of Federation to extend full and complete rights and privileges to alien life forms—whether created as a result of organic evolution or as a result of artificial processes—if sufficient evidence of sentience exists.

ONE REMARKABLE MACHINE

As for Mr. Data himself, few would deny that this being is, in many ways, far superior to his naturally evolving Human counterpart. In addition to Mr. Data's many achievements as a Starfleet officer, this individual enjoys a wide variety of enhanced features and functions. Not only can he replicate Human physical, biological, or mental functions, but Mr. Data's positron brain offers other notable advantages, not the least of which is rapid analysis of information at speeds greater than those of an organic, Human brain. He also has the ability to store the emotional and descriptive memories of multiple personalities, which was his original purpose under Soong's direction. In addition, the servo-mechanisms that drive his motive powers provide him with enhanced strength, speed, and dexterity beyond those of his fellow crewmembers, as well as internal diagnostic checks that can pinpoint the nature of any mechanical "illness" with precision. Moreover, his enhanced hearing and ability to thermally scan into the infrared spectrum allow him to accurately map any terrain countour with remarkable precision. He is, when all is said and done, one remarkable machine.

—Dr. Jamesson Ingermann, "Functional and Funny: A Report on the New Model Human", *Star Fleet Times*, Star Fleet Command Press, Mars, Sol IV, Stardate 2/9204.15

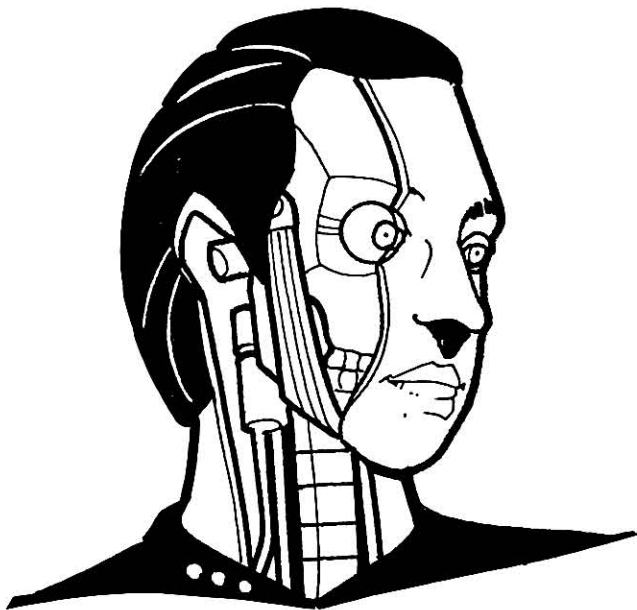
**SCHEMATIC OVERVIEW**

Following is a schematic overview of the artificial being known as Mr. Data, creation of the late Dr. Noonian Soong. This table clarifies the accompanying illustration.

Positronic Brain

The Data unit is controlled by an organic-enhanced synaptid processor powered by a micro-positron flow that mimics the functions of the Human nervous system with micro-relays duplicating the operations of brain engram patterns.

Audio Sensors

The Data unit's auditory sensors maintain a constant monitoring of wavelengths that extend into the ultrasonic frequency range as well as being able to detect sound of only a few decibels in strength at short distances.

Visual Sensors

The Data unit's enhanced visual sensors are designed to detect wavelengths of light ranging from the ultraviolet to the infrared portion of the spectrum.

Speech Synthesis

The Data unit is capable of synthetically reproducing any desired sound made by Human vocal chords as well as of "playing back" exact voice patterns of conversations held in its presence and now stored in its memory.

Central Power Cavity

Located in the unit's upper torsal region is the Central Power Cavity. Here is where energy is released to power the unit. This energy is generated by the decay of a small quantity of the radioactive isotope strontium 90, and distributed to the entire unit through a unique, direct flow of charged electrons in a fluid nutrient base of a consistency similar to Human hemoglobin. The entire upper chest cavity area is surrounded by lightweight ceramic-lead baffling that can expand and contract with simulated breathing, while protecting close observers from stray radiation exposure.

Servo Pumps

A variety of micro-circuited servomechanisms located directly beneath the central power cavity aid circulation of the unit's nutrient internal solution, permitting the efficient transference of charged electrons as a power source.

Data Storage Unit

Located in the lower torso region, the unit's auxiliary data storage center maintains over ten thousand silicon wafers, each integrated by direct lead to the positronic brain center, providing instant access to tens of billions of bytes worth of information on call.

Hand Manipulators

The Data unit's arm and hand units replicate the function of normal Human equivalents. A collection of micro-sized sensors arrayed in patterns resembling Human fingerprints are provided, giving the unit enhanced tactile receptivity.

Internal Digestive Exchanger

The Data unit design includes a chemical collector that breaks down chemical nutrients into usable particles able to be absorbed directly into the unit's system, releasing energy for storage through a simulated process of oxidation. If required to do so, the Data unit can duplicate Human digestion with an efficiency that rivals an organic system.

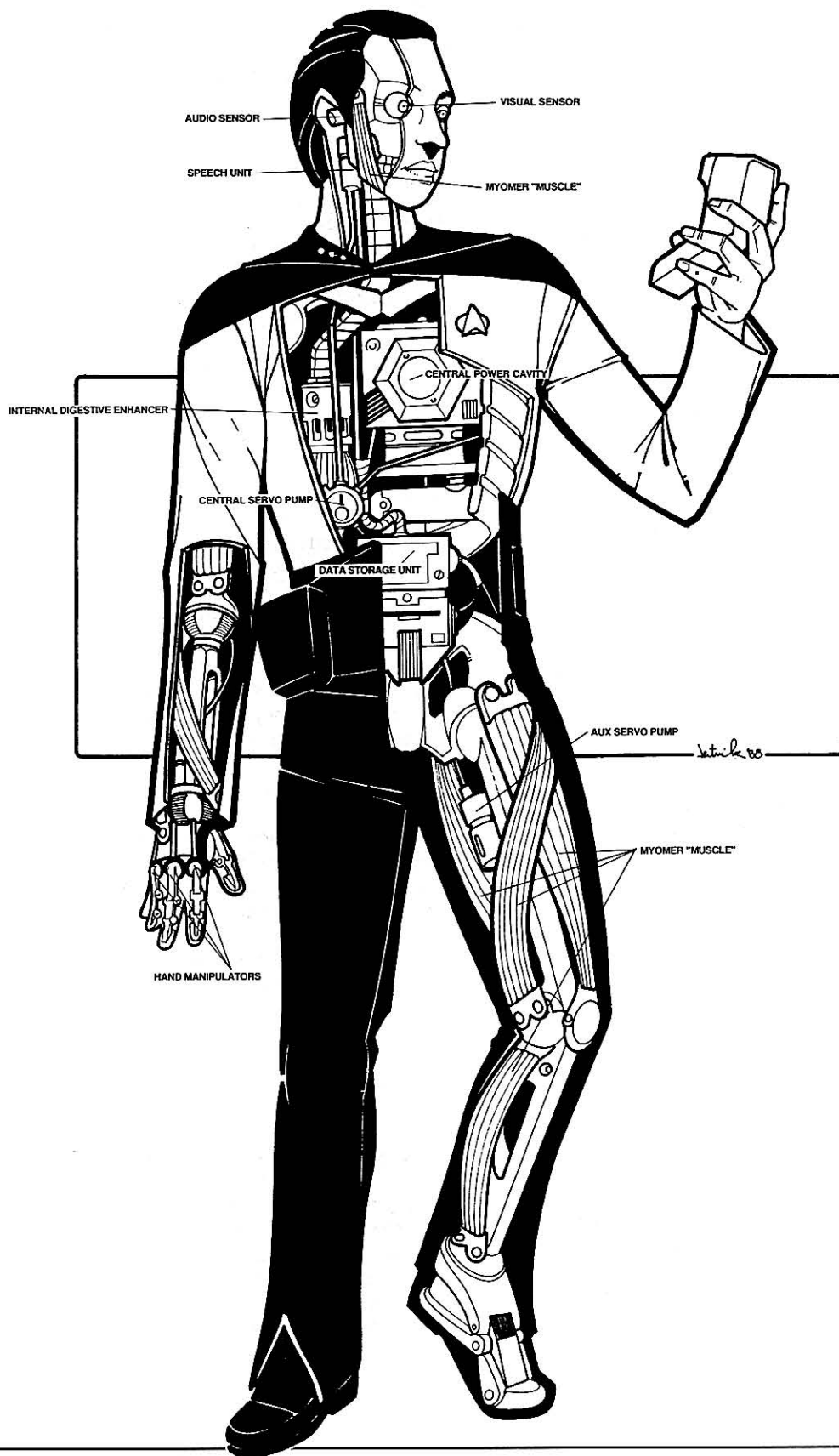

HOLODECK OPERATION

The original Holodeck design was pioneered by Dr. Simone Van Gelder. Working with numerous Federation engineers and transporter technology scientists, this noted psychologist sought a means of duplicating real-life events with an undreamed-of degree of realism in order to treat patients suffering from severe mental disorders. Dr. Van Gelder believed that three-dimensional re-creations of a patient's fears and phobias, or the reproduction of a specific traumatic point in a patient's life, would permit the individual to confront or relive the experience and to alleviate and even overcome long-standing emotional problems. The key to this revolutionary treatment was a specially designed computer that could direct matter-transmitter devices to "construct" physical objects and surroundings from bulk matter by altering the atomic structure of the ordinary matter into "living, breathing" representations of the patient's needs, wants, fears, and desires. For her achievements, Dr. Van Gelder became the first recipient of the prestigious Cochrane Award in Science in over two decades. Starfleet command has since extended the practical application of her achievement for training and recreational purposes.

The basic mechanism in the functioning of the ship's Holodecks is the Holographic Matter Scrambler, made up of hundreds of thousands of omni-directional holo diodes that project a variety of finely tuned electromagnetic fields. These Holo Diodes cover the entire surface of the holodeck walls to act collectively as a three-dimensional matrix for computer mapping. Under the control of the main AICS computer, subsystems direct the use of the diode-driven scrambler. In addition to the scrambler's ability to display three-dimensional holographic images of selected patterns—places, people, or events—it manipulates the electromagnetic fields generated by the Holo Diodes to simulate tactile sensations of sight, sound, smell, temperature, and atmospheric density to further enhance the realistic "feel" of the environment created. The Holodeck's computer systems constantly monitor these electromagnetic fields from the user's point of view. As he moves around the Holodeck, the holographic patterns also change to reflect the correct "facing" of objects being simulated.

When more complex patterns are required, the likes of which would tax even the memory and functional limits of the duotronic Holodeck computers, the Holo scrambler can draw upon a store of bulk matter via the ship's transporters. The scrambler, as its name indicates, uses intership beaming capacities to rearrange the molecular patterns of bulk matter into whatever new matrix the computer selects. Thus, in effect, it can turn sand into gold, helium into spring water, carbon into living room furniture, and so on.

In cases where the user wishes to simulate desired situations, places, or conditions not already stored in the Holodeck's imaging control computers, he can access the Holodeck's computer operational system and to give it detailed specifications on the situation to be generated. The Holodeck control computer formulates a new data program from these specifications, an entirely new operations matrix that will then be stored for recall upon presentation of an identification code. Such computer-generated request patterns may be either static or dynamic. A static pattern simulates a specific geographic location or point in time as a three-dimensional "mirror-image". A dynamic pattern produces computer-generated and controlled simulations of real people and other life forms. Based on computer generated speech patterns, response lists, and action tables, these life-form simulations can interact with the Holodeck user. To accomplish these complex functions, the Holodeck computer draws on the near-limitless resources of the ship's main computer banks for the information needed to fine-tune its newly created productions into "life."

ADVANCES IN SHIPBOARD WEAPONRY

Though the conflicts of the 23rd century were numerous, they were essentially small engagements. With the threat of the Ferengi and renewed Romulan aggressiveness, that may no longer be the case if hostilities break out once more. To prepare for such contingencies, Starfleet must divert extensive resources into the design and development of new and improved weapon systems in hopes of deterring any would-be aggressor.

In recent years, Federation weapon technology has proceeded along parallel lines of development. The linear approach has produced increasingly larger weapons with increased ranges and firepower. In the non-linear approach, research has been directed toward creating a means to combine larger numbers of light-weight phaser systems into a single energy stream at a single target point. The result of this approach was the successful installation of the collimator ring system aboard the new *Galaxy* Class cruiser.

The collimator ring is essentially an electromagnetic ring in which the charged particle beams of phaser energy can be safely contained and then channeled to numerous weapon hardpoints along the ship's exterior. By sending the flow of phaser energy through containment tubes leading to collection and internal maintenance torque rings along the base of the ship's main saucer section, the combined energy of several phaser batteries can be collected and dispatched against a single target in one devastating arc of energy.

As for supplemental photon torpedo launch systems, theoretical limits of magnetic field containment systems have imposed a practical limit on the destructive energy possible in the standard torpedo design. Advances in computer fire-control systems have made multi-tube, rapid-fire barrages of photon torpedoes a practical tactical option, however. A vessel mounting a single pair of photon torpedoes in any direction can lay down a pattern of several dozen torpedoes in seconds.

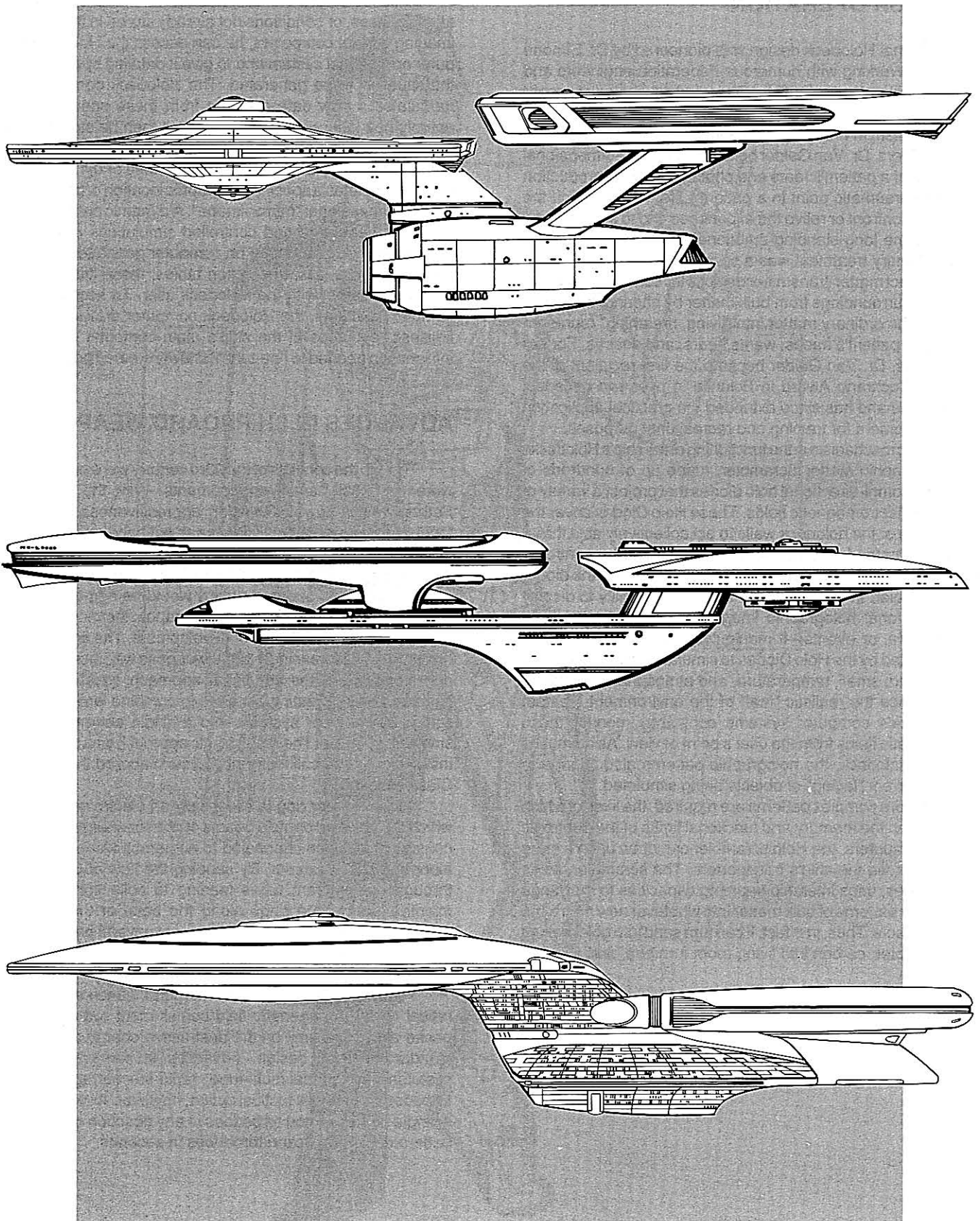

This section discusses recent exploration efforts by Star Fleet Command. Information on contact with newly discovered sentient races and the general expansion of the Federation over the last half century is included.

FEDERATION GRAND ALLIANCE

At present the Federation Grand Alliance encompasses a volume of space spanning more than 10,000 square parsecs, the largest space under the control of a single galactic governmental agency. The Alliance's two principle members, the United Federation of Planets and the Free Worlds of Klinzai, govern the inhabited worlds within their traditional spheres of influence as well as jointly governing new worlds discovered during the course of normal exploration.

Within the United Federation of Planets, Star Fleet Command is directly responsible for maintaining the peace throughout an area extending over 8,000 parsecs in size. This region of space is divided into ten administrative sections. The first four represent the original four quadrants of the Federation. The remaining six, referred to as Exploration Zones Alpha, Beta, Gamma, Delta, Sigma, and Theta, represent newly explored and colonized areas of space that have been charted since the advent of the transwarp drive.

Exploration Zone Alpha is the least explored, extending beyond the rim of Quadrant II into the region lying between the Tholian and Gorn spheres of influence. Exploration Zone Beta extends outward from Quadrant II along the "northernmost" edge of Tholian space toward the galactic core. Exploration Zone Gamma extends from the centermost regions of Quadrants II and III, toward the core of the galaxy. Exploration Zone Delta proceeds from Quadrant I both coreward and spinward and is the most heavily colonized. Exploration Zones Sigma and Theta lie spinward of Quadrants I and IV, respectively, and are a region of space explored and colonized jointly by the Federation proper and the Free Worlds of Klinzai.

Besides the numerous Federation and Klinzai colonies, these exploration zones also contain many independent worlds that owe no allegiance to either governing body, but do remain under the protection of the Alliance.

THE ALLIANCE AT A GLANCE

Following is a summary of statistics on the current size and state of the Grand Alliance.

Total Volume of Space Occupied:

Grand Alliance	10,255 parsecs
United Federation of Planets	8,200 parsecs
Free Worlds of Klinzai	2,055 parsecs

Number of Charted Worlds:

Grand Alliance	4,056 planets in 1,514 star systems
United Federation of Planets	2,706 planets in 894 star systems
Free Worlds of Klinzai	1,350 planets in 620 star systems

Number of Inhabited Worlds

Grand Alliance	3,802 planets
United Federation of Planets	2,401 planets
Free Worlds of Klinzai	1,401 planets

Number of Indigenous Civilized Races

Grand Alliance	2,598, with 1,400 starfaring races
United Federation of Planets	1,958, with 1,200 starfaring races
Free Worlds of Klinzai	660, with 103 starfaring races

Current Population

Grand Alliance	759 trillion inhabitants
United Federation of Planets	589 trillion inhabitants
Free Worlds of Klinzai	170 trillion inhabitants

NEW RACES

In recent decades, many sentient life forms have been discovered as the new transwarp starships have penetrated deeper and deeper into the galactic core. This section provides background on several key new races with whom the Federation has come in contact, including races that have become members of the Federation, as well as those who remain independent.

FEDERATION MEMBERS

The three cultural logs that follow are included as representative of the types of newly discovered races who have sought membership in the United Federation of Planets.

Betazoids

Initially encountered nearly a century ago, the Betazoids have recently begun to make a significant contribution to the cultural advancement of the Federation. An innately placid and peaceful people, the Betazoids originated on their homeworld of Haven, one of the most beautiful and psychologically comforting places in the galaxy. Because of the tranquil atmosphere of Haven, legends of miraculous healing properties have come to be associated with the planet and its people. Thousands of Federation citizens visit the planet each year, hoping to benefit physically and spiritually from this uniquely restful environment. The inhabitants of Haven are also known for their telepathic and empathic abilities. Each Betazoid is capable of easily establishing telepathic links across great distances with members of his own kind, and of establishing limited telepathic communication with other sentient life forms over lesser distances. Moreover, Betazoids can sense and influence the emotions of others at close range.

Because of this combination of abilities, the Federation has created a new officer position within Star Fleet, that of Ship's Counsellor, which is staffed exclusively by Betazoids. In this role, Betazoid empaths provide the ship's Captain with invaluable information on the emotional and mental states of other life forms aboard ship at a moment's notice. This is a major advantage in negotiations as well as for monitoring the state of a ship's crew under emergency or otherwise stressful conditions. The Betazoids are ruled by a matriarchy similar to that of Vulcan.

Physical Description:

Betazoids are tall, statuesque, bipedal Humanoid life forms who resemble standard Terran stock. The gentle climate of Haven and the total egalitarianism of the social system give the average Betazoid a typical lifespan of between 100 and 150 standard years. Since their discovery and subsequent membership in the Federation, numerous Betazoids have mated with Humans. The progeny of these interspecies unions are indistinguishable from otherwise standard Humans or humanoid life forms found elsewhere in the galaxy.

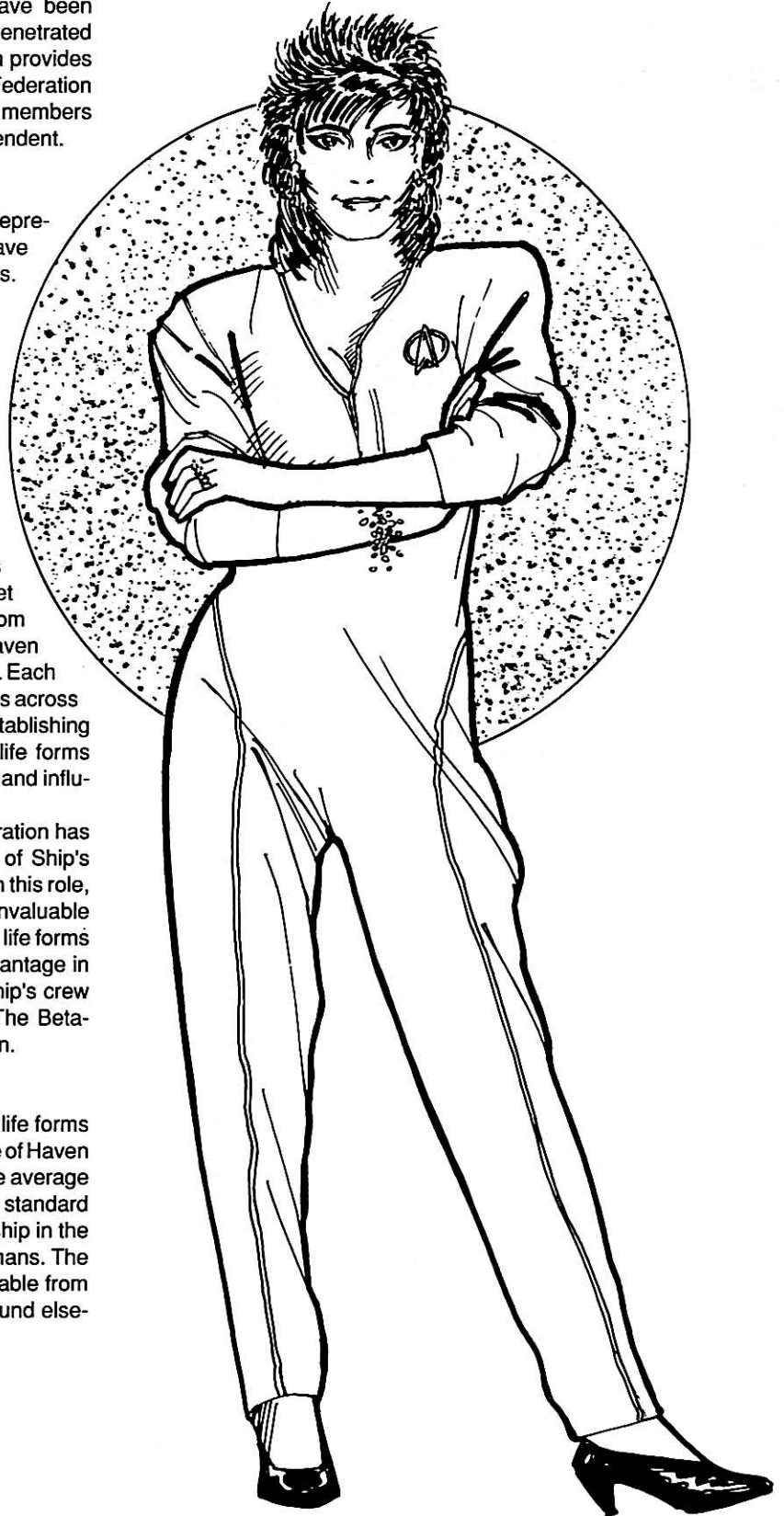

Binars

The Binars represent a radical departure in terms of social system as well as physical appearance. Discovered only recently, the Binar race is unusual in making no distinction between male and female genders. Instead, the Binars live in a close symbiotic relationship with another of their species throughout their entire life, each pair acting, moving, thinking, and communicating in a coordinated unity that offworlders find particularly alien and disconcerting at first.

Like the older Cygnian race, the Binars' only science is that of computer technology, but their expertise rivals that of the Cygnians. Binar society is directly controlled by a global computer system. Though the process is not completely understood at present, it appears that each Binar's life force directly influences the continued programming and growth of the master computer, and in turn, the functions of the master computer regulate the life forces within each Binar. Binar language is, not surprisingly, a form of high-frequency coded transmissions in a mathematically based binary format that facilitates the rapid communications of massive amounts of information that each Binar receives and stores for "processing" as needed.

Physical Description:

The typical Binar linked pair are small, vaguely humanoid bipeds with enlarged, oval heads and large eyes that extend part way around the head to give them a greater field of peripheral vision. Because of the race's pale complexion and spindly stature, some historians have suggested that the Binars correlate with descriptions by early Terran accounts of aliens and UFO's (unidentified flying objects, hundreds of which were catalogued during the 20th century.) This theory has provoked considerable debate, especially as no direct evidence indicates that the Binars ever developed interstellar flight. They are, however, reticent to discuss such matters with outside investigators.

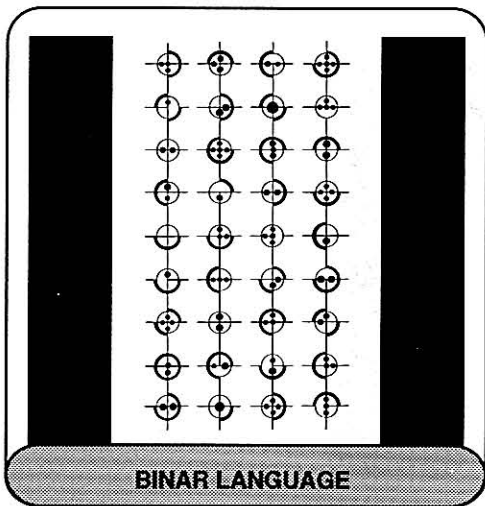
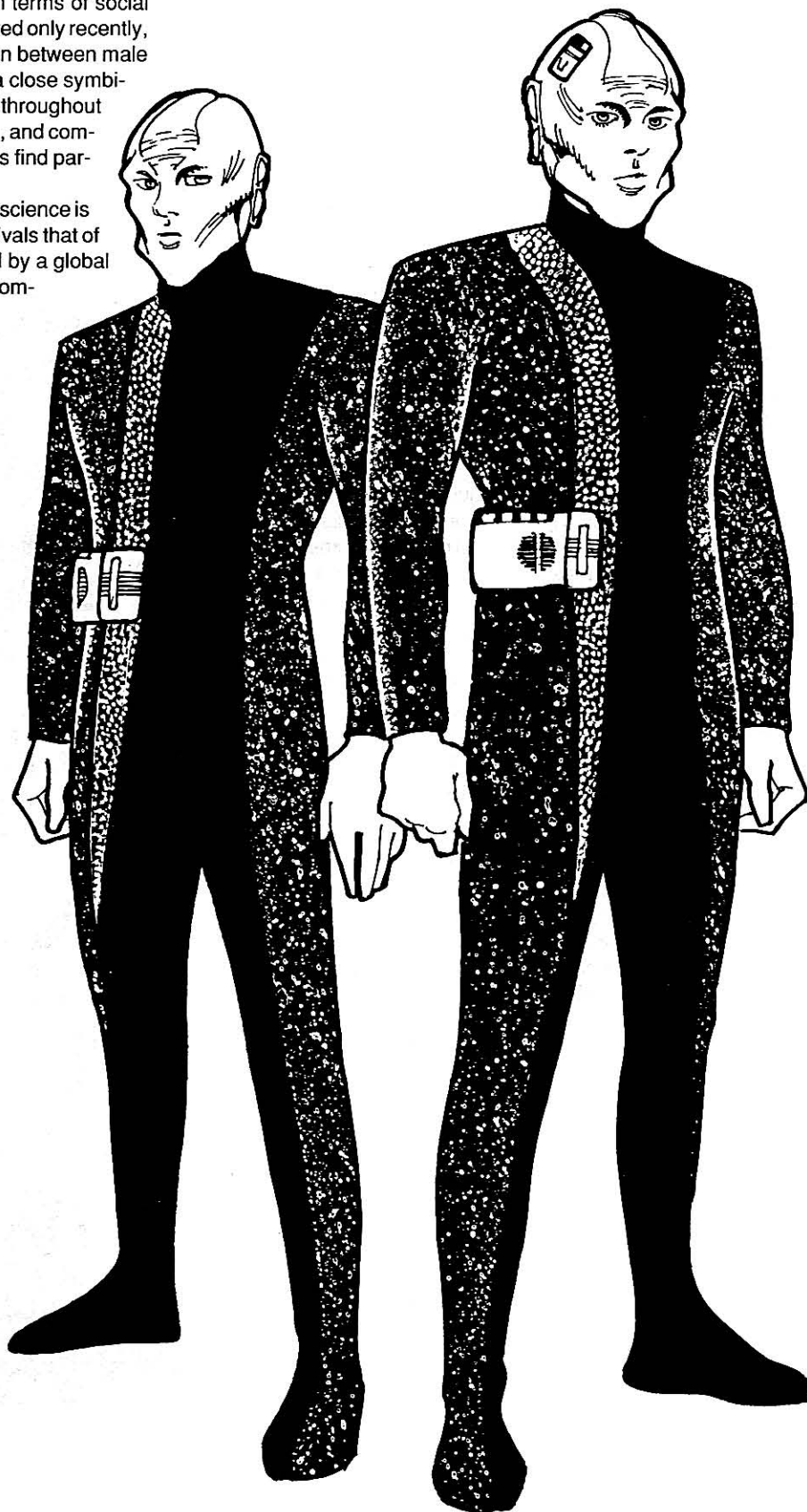

Molodor

The Molodor are a humanoid species who can claim the dubious distinction of carrying on the longest uninterrupted civil war of any planetary society in recent memory. When first contacted decades ago, the Molodor were fragmented into dozens of independent governmental blocks, each warring with the other over scarce resources. Through the mediation efforts of Starfleet Admiral Carstairs, this 40-year period of continuous civil strife was finally ended. As a result of this on-going conflict, the planet's surface remains largely uninhabited, and the population reduced to a meager existence in underground complexes. Since joining the Federation, the Molodors have slowly begun to reverse the downward spiral of social and economic destabilization through cultural and economic aid, but the situation is still dismal. Best estimates state that it will be several centuries before the Moldorian race rises again to the level of their prewar civilization.

Physical Description:

The typical Moldorian is indistinguishable from standard Terran stock, though high levels of surface radiation have created a critically high incidence of radiation sickness and genetic mutation that result in very short life spans.



INDEPENDENTS

The following cultural logs are included as representative of the newly discovered races who have retained ties with the Federation but do not seek formal membership status.

Ligonians

The Ligonians are a planet of warriors almost totally lacking in basic technology, similar in many ways to ancient Terran cultures such as the Zulu tribe. The Ligonian society is based on a strict code of honor that elevates the way of the warrior and demands the subservience of its females. A male tribal council rules Ligon. The planet is also noted for its rare and valuable plants that, in processed form, have provided remedies for a number of medical disorders previously incurable on other Federation worlds.

Physical Description:

With their dark skin and compact, well-muscled bodies, the Ligonians resemble several Terran cultures from the United States of Africa.

Edo

Only recently discovered, the Edo (not to be confused with a sentient race of amphibians by the same name commonly known as Saurians) are a humanoid race dedicated to the single principle of health and spiritual perfection through physical fitness. Though highly advanced, the Edo show no interest in interplanetary, let alone interstellar, flight. They are a friendly people whose main motivation is to enjoy the richness of life. It should be noted, however, that the Edo maintain a society free from strife through a Draconian system of punishment rarely spoken of even among themselves. Outsiders, however, are usually warned that any infraction against social conventions is punishable by immediate execution of the offender, without appeal.

Physical Description:

The beautiful physical bodies of the Edo represent the highest development of physical health and prowess in the known galaxy.

Angelites

Angel One is a recently rediscovered colony world that was settled during the Back-To-Earth movement of over century ago. Despairing of their political dream of disbanding the Federation and restoring Terra as Mankind's primary world, the female leaders of the movement abandoned the Federation to create a model culture of their own. Then they disappeared without a trace decades ago. When Angel One was rediscovered some 60 years ago, it still existed as a female-dominated republican order. The population rejected out of hand all further contacts with the "hated old order" of the Federation until recently when a Federation vessel engaged in rescue operations made renewed contact with the Angelites a necessity. In the social order of Angel One, the females hold total power and the males are regulated to menial positions in the government and the home.

Physical Description:

The original Angelites were of Human ancestry. The dominant females of the culture typically wear full-length silk gowns in various colors; the males wear similar clothing, but of a more revealing nature.

Bandi

The Bandi were one of the first humanoid races discovered after transwarp-driven vessels increased coreward exploration. Until recently, the Bandi provided support for Federation vessels with a ground-based starbase installation on their planet. Not long ago, Starfleet personnel discerned that the Bandi "star base" was, in reality, a gigantic sentient life form capable of molecular transmutation, which the Bandi kept in captivity. After the creature was rescued by one of its own kind (after destruction of the old Bandi capitol on the planet's surface), the Bandi agreed to rebuild a new base facility on their homeworld using more conventional means.

The Bandi are essentially nomadic peoples grouped together for convenience in loosely organized tribal units, each directed by a headman known as the "Graplar", or "gather chief." The Bandi planet is a veritable storehouse of geothermal energy, which is presently being harnessed as a natural source of power for the future needs of both the Bandi and the Federation.

Physical Description:

The Bandi are medium-sized Humanoids who wear their long, stringy hair woven with multicolored beads to denote status. Bandi typically wear loose, long robes suitable to their nomadic life and the arid climate of the habitable portions of the planet. Most go barefoot or only lightly shod in other environments.

Selayans

The Selayans are intelligent reptiloids toward whom the Federation has recently made diplomatic overtures. We know that the race possesses a rudimentary knowledge of interplanetary flight and that they have used this ability to prosecute a war of racial extermination against their nearest planetary neighbors, the Anticans. Both races are extremely xenophobic. The Federation has recently attempted to play the role of mediator to end the hostilities after receiving reports of Ferengi influence in the Selayan star system.

Physical Description:

With their green, scale-like skin, the Selayans resemble ancient Terran cobras. Their average height is about 1.8 meters, and they stand upright on two legs. Selayans typically wear long, ornate robes that denote social rank and station. In the presence of outworlders, most remain hooded to cover their features as much as possible.



The Anticans

The Anticans are intelligent mammals vaguely resembling Terran canines. A predatory people who have only recently developed a civilized social order, their cultural progress has been interrupted by the arrival of the Selayans, who have been attempting to conquer the Antican homeworld. The Anticans are a carnivorous species who take great enjoyment in the hunt and the ritualistic feasting on their fallen prey. Indeed, they have begun to carry out these socially complex behavior patterns glorifying the pack kill and the joy of devouring fresh meat at the expense of Selayan invaders. The Federation is currently attempting to negotiate an end to the hostilities between the two races.

Physical Description:

The Anticans are bipedal creatures evolved from canine stock. They have large, slightly misshapen heads that indicate recent genetic mutations, and abundant facial and body fur. Their sharp incisor teeth assist in consumption of their favorite food, raw red meat.



STAR FLEET POLICIES AND PROCEDURES 134

ADVANCED TRAINING PROGRAMS

One of the major recent changes in the structure of Starfleet has been the Starfleet Academy training program for starship officers. As it became apparent that officers needed to be proficient in a variety of interrelated shipboard functions, rather than in a single, specialized skill area, the new training procedures were developed. They have resulted in increased general shipboard efficiency and streamlined ship crew complements. Because of the program's initial success, Starfleet now emphasizes the concept of the "integrated specialist" in place of the individual specialties in Helm, Navigation, and so on. With the launching of the *USS Enterprise*, first of the new *Galaxy* Class exploration cruisers, Starfleet embarked on the bold experiment of using only officers who are products of the Academy's new integrated training procedures. Starfleet officials expect that this should produce superior crew proficiency ratings, and eagerly await the results of the new *Galaxy* Cruiser's first deep-space mission.

INTEGRATED SPECIALIST

During their first year at Starfleet academy, the new officer cadets undergo a variety of rigid physical conditioning training processes to prepare them for life aboard ship as well as survival on hostile worlds. As a complement to this physical conditioning, cadets must take a battery of courses that introduce them to life as a Starfleet officer, provide a basic understanding of Federation law, politics, and varying social systems as well as developing the skills they will need.

During their second year at Starfleet academy, cadets are posted to one of several training "tracks" in which they will continue to receive integrated training for the rest of their time at the Academy. The various Integrated Specialist options to which cadets may be posted are: Bridge Command Specialist, Tactical Command Specialist, Defense Command Specialist, Life Sciences Specialist, and Engineering Systems Specialist. Each specialist assumes a variety of roles and shares the duties and responsibilities of these with his fellow crewmates. The Integrated Specialist must have functional mastery in a variety of traditional skills previously assigned to independent officers. The Integrated Specialist Skill Table lists the specialist options and the skills that cadets must be able to perform upon the completion of their studies at Star Fleet academy.

In his third year at the academy, each cadet begins a period of selective cross-training leading to one of several specialist

option classifications. During the first half of the year, the cadet learns from practical demonstrations and hands-on exercises how to integrate skills obtained to date with the skills of other divisions aboard ship. In the second half of the year, each prospective officer undergoes six months of cross-training at Starfleet's Marine Training School on Charon in the Sol system.

During this time, each cadet submits to a rigorous period of intensive survival training to develop skills such as Zero-Gravity Operations, Shuttlecraft Piloting and Mechanics, Personal Weapons Training, Planetary Navigation and Survival, Small Unit Tactics, Emergency Weapons Manufacture, and Ground Vehicle Operation. The six month training course culminates in a series of anti-aggressor maneuvers in which naval combat teams must locate and nullify the attempts by intruding teams of marine specialist instructors to sabotage an important ground-based installation. Given the difficulty of these maneuvers, it is not unusual for more than one cadet to fail some portion of the cross-training exercises, which will require that he take a refresher course at some later time prior to graduation.

In fourth year at the academy, each cadet continues his or her Specialist Cross-Training to ensure effectiveness in a variety of roles. During the last four months, the cadet is temporarily assigned to a star base on one of several member planets as part of a cultural exchange program. This is usually the cadet's first opportunity to experience a completely alien culture, an exposure essential to developing the ability to interact with members of other races whom they will encounter and may even some day command.

The exchange cadet is usually assigned to a ground-base staff officer who provides further instruction in practical day-to-day routine base operations as well as an introduction to alien cultural styles and customs. In many cases, this training is handled by the base's Tactical Officer. In other cases, a cadet may be assigned to a Federation diplomatic attache or science advisory staff, where he will put to use a combination of skill-oriented and cultural-oriented tasks.

Following completion of Academy studies, all cadets present themselves to an officer of command rank, who will lead a group of cadets during a cadet cruise aboard an actual starship for a period of six months to a year. During this time, cadets have the opportunity to test the skills they have studied under actual working conditions and in simulated emergency situations. Based on his performance, each cadet will either pass, pass with honors (and receive promotion two grades), or be required to repeat the cadet cruise at the earliest opportunity.

INTEGRATED SPECIALIST SKILL TABLE

Specialist Option	Major Skill Areas
Bridge Command Specialist	Helm Control, Navigation, Communications Sensor Analysis, Deflector Shield Operation Computer Operation, Negotiation and Diplomacy
Tactical Specialist	Security, Communications, Starships Weaponry, Starship Combat Strategy and Tactics, Deflector Shield Operation, Computer Operation
Defense Systems Specialist	Damage Control Procedures, Deflector Shield Technology, Small Systems Operation and Technology, Electronics, Mechanical Engineering
Life Sciences Specialist	Computer Operation, Sensor Analysis, Life Support Systems Technologies, General Medi- cine, Biology, Psychology
Engineering Systems Specialist	Computer, Operation Mechanical Engineering, Warp Drive Technology, Navigation, Helm Operation, Physics, Electronics, and individual subsystems specializations in three addi- tional skill areas.

ACADEMY CORE CURRICULUM

To acquaint the cadet with the nature of Starfleet training and the rigorous demands each officer trainee faces, following is a brief description of the required and elective courses that make up the Star Fleet Academy Core Curriculum. Each year of study is divided into three trimesters of approximately 16 standard weeks. Note that some courses listed as electives below may be required courses for some specialist programs. Graduation requires completion of a minimum of 340 trimester hours, though some specialist programs may require additional hours in different program tracks.

FIRST-YEAR COURSES

Required Courses

Advanced Mathematics	3 hrs
Armed Combat Training	3 hrs
Astrogation and Space Science	2 hrs
Computer Operation	2 hrs
Federation Cultures/Social Customs	3 hrs
Federation History	3 hrs
Federation Law	3 hrs
Galacta I	4 hrs
Hand-To-Hand Combat	3 hrs
Introduction to Warp Mechanics	3 hrs
Physical Conditioning I	6 hrs
Officer Leadership I	4 hrs
Starship Life and Procedures	3 hrs
Starship Sensor Systems Operations	3 hrs
General Medicine, Humanoid	3 hrs

Total: 48 hrs + 12 hrs electives = 60 hrs

Electives

Alternate Time Probabilities	1 hr
Applied Electronics	6 hrs
Computer Science/Technology	2 hrs
Dimensional Mathematics	2 hrs
Galactic Astronomy	3 hrs
General Biology	3 hrs
General Chemistry	3 hrs
Interstellar Trade and Commerce	2 hrs
Small Systems Technology	2 hrs
Physics	2 hrs
Planetary Ecosystems	3 hrs
Planetary Government Systems	4 hrs
Planetary Geology	3 hrs
Psychology, Human	3 hrs
Terran Military History	3 hrs
Terran Social History	3 hrs

SECOND YEAR

Required Courses

Applied Medical Techniques	10 hrs
Deflector Operation/Technology	3 hrs
Galacta II	3 hrs
General Medicine, Klingon	3 hrs
Hand-To-Hand Combat II	3 hrs
Klingon History and Culture	3 hrs
Officer Leadership II	8 hrs
Physical Conditioning II	20 hrs
Starship Communications Operations	3 hrs
Starship Helm Operations I	4 hrs
Starship Navigation Principles I	4 hrs
Star Fleet Security Procedures	4 hrs

Total: 68 hrs + 12 hrs electives = 80 hrs

Electives

Advanced Biology	3 hrs
Advanced Chemistry	3 hrs
Advanced Warp Mechanics	4 hrs
Alien Medical Psychologies	3 hrs
Applied Genetics	3 hrs
Archaic Weapons Systems	1 hr
Astrophysics	2 hrs
Emergency Weapon Construction	1 hr
Federation Literature	3 hrs
General Pathology	4 hrs
Hyperspatial Mathematics	4 hrs
Interstellar Languages	
Andorian	3 hrs
Klingonaase	3 hrs
Orion	3 hrs
Romulan	3 hrs
Tellaran	3 hrs
Vulcan	3 hrs
Mechanical Engineering I	3 hrs
Orion History and Culture	3 hrs
Plasma Physics	4 hrs
Psychology	
Klingon	3 hrs
Romulan	3 hrs
Surgical Conditions and Procedures	5 hrs
Transporter Systems Operations	4 hrs

THIRD YEAR

Required Courses

Emergency Command Procedures	3 hrs
Environmental Suit Operations	3 hrs
Ground Vehicle Operation	3 hrs
Ground Vehicle Maintenance	3 hrs
Officer Leadership Development	8 hrs
Physical Conditioning II	16 hrs
Planetary Survival	20 hrs
Small Unit Tactics	20 hrs
Starship Navigation Principles II	4 hrs
Starship Navigation Principles II	4 hrs
Shuttlecraft Operation	4 hrs
Zero-Gravity Combat Techniques	4 hrs

Total: 88 hrs + 12 hrs electives = 100 hrs

Electives

Artistic Expression	2 hrs
Advanced Electronics	4 hrs
Advanced Pathology	4 hrs
Biochemistry	4 hrs
Electrochemical Physics	3 hrs
Energy Weapon Construction	6 hrs
Computer Cybernetics	3 hrs
High-Energy Particle Physics	3 hrs
High-Energy Weapons Systems	4 hrs
History of Federation Military Tactics	6 hrs
Impulse Drive Systems Technologies	5 hrs
Mechanical Engineering II	3 hrs
Shuttlecraft Maintenance	2 hrs
Starship Helm Operations II	4 hrs
Xenobiology	6 hrs
Xenopathology	6 hrs

FOURTH YEAR

Required Courses

Administration, Theory and Practice	6 hrs
Alliance Government	10 hrs
Cadet Cruise Orientation/Preparation	12 hrs
Federation Diplomacy, Theory and Practice	5 hrs
Instructional Techniques	3 hrs
Officer Leadership Development	10 hrs
Physical Conditioning IV	10 hrs
Psychology of Command	4 hrs
Spacial Combat Strategies	6 hrs
Staff Officer Leadership Development	10 hrs
Starship Navigation Principles II	4 hrs

Total: 80 hrs + 20 hrs electives = 100 hrs

Electives

Advanced Communications Applications	4 hrs
Advanced Cybernetics	4 hrs
Advanced Security Procedures	4 hrs
Advanced Surgical Techniques	
Humanoid	8 hrs
Alien	8 hrs
Advanced Warp System Technologies	6 hrs
Artistic Expression	2 hrs
Federation Corporate Structures	2 hrs
Federation Leisure Systems	1 hr
Fencing	3 hrs
History of Federation Scientific Develop	3 hrs
Hospital Administration Principles	6 hrs
Hyperspatial Circuitry Construction	2 hrs
Medical Internship	20 hrs
Star Base Operations, Introduction to	3 hrs
Transporter Systems, Advanced Theory and Practice	4 hrs

AWAY TEAMS

The Away Team combines the functions of the landing party and initial contact team that have been part of Starfleet from the start. The purpose of the Away Team is to conduct scientific and cultural research away from the command ship and to conduct diplomatic initiatives that the ship's Captain deems necessary.

The modern-day Away Team differs from its predecessors in that it is intended to minimize risk to a ship's Captain. Starfleet Command was concerned over the unnecessary risks often taken by command officers as members of landing parties because they could lead to the loss of experienced, highly trained, and valuable senior officers in situations that might be handled by subordinates. Thus, current Starfleet regulations forbid a ship's Captain to undertake command of an Away Team (though he or she may subsequently join the team if circumstances warrant).

AWAY TEAM OPERATIONS

Regulations concerning the composition and use of Away Teams have been set down by Starfleet. The following material is from the 77th revised edition of *Starfleet Training Command Regulations*, 2/3002.1.

Command of an Away Team shall be entrusted to the ship's First Officer, or, barring the availability of this officer, the ship's Chief Science Officer. Under no circumstances is a ship's Captain permitted to command an Away Team or to operate with an Away Team until the Captain's safety (and that of other senior officers) can be assured.

Unless circumstances dictate otherwise, an Away Team shall be directed by the ship's senior officer other than the ship's Captain. In addition, it will be composed of one Security Officer, one or more Bridge Command Specialists, and either a member of the ship's medical staff, a Federation cultural specialist, or a science specialist. This is the minimum number of personnel that Away Team operations require.

A ship's Captain may voluntarily join the members of an Away Team at the discretion of the Away Team's commanding officer, and with the approval of the team's Security Officer. These officers will give their approval *only* if the security of the ship's Captain can be reasonably assured.

At the discretion of the ship's officer commanding, all members of an Away Team may be armed and display such armaments.

During operations away from a command vessel, one transporter station must be fully manned and held in reserve for immediate priority use by the Away Team at all times. Ship's sensor systems shall be directed to maintain a constant locational fix on all Away Team members. If the locational fix on any member of the Away Team is lost, all remaining members of the Away Team shall be transported immediately aboard ship, or alternately, shall be transported to the last reported location of the missing team member. **NO OTHER OPTIONS ARE AVAILABLE IN THIS SITUATION!**

Upon return to the command ship, all members of the Away Team shall make themselves immediately available to the ship's Captain for debriefing and situation review.

NEW GENERAL ORDERS

Established through the Executive Orders of the Alliance Council, Starfleet General Orders specify the extent to which the Federation's civilian administration maintains control over Starfleet Command, and conversely, the extent to which Starfleet Command exercises influence over Federation policies, growth, and development. In the last century, the number of revised General Orders had risen to 25. More recently, six new general orders have been mandated, reflecting changing attitudes and social awareness within the Alliance. These new general orders are reprinted below.

GENERAL ORDER 26 (STARDATE 2/7704)

No member of a ship's complement or other ground-based installation can be held directly accountable for the actions of their superiors. Similarly, no member of a ship's company or other Starfleet personnel will share disciplinary measures taken against their commanding officer(s) if said individuals were not directly involved in the actions leading to disciplinary measures. This order extends to conditions involving proven violations of the Prime Directive, where proof of such violations exist.

GENERAL ORDER 27 (STARDATE 2/8205)

No member of Starfleet shall be required by the assignment of standard duties and responsibilities to undergo extended separation from his family if family members can be reasonably provided for aboard ship or as part of an existing Starfleet installation.

GENERAL ORDER 28 (STARDATE 2/9007)

No officer of command rank shall be removed from command status unless such action has the complete and unqualified agreement of at least three senior officers present. Whenever possible, such officers shall include the ship's First Officer, Chief Medical Officer, a Ship's Counselor, and one junior officer of command station.

GENERAL ORDER 29 (STARDATE 2/9407)

The primary responsibility of the commander of any Starfleet vessel is the welfare and safety of his crew, including any civilian members of the ship or installation's complement. No action may be taken that creates an unwarranted threat to the safety of those individuals under the officer's charge, except in the line of duty and when otherwise unavoidable.

GENERAL ORDER 30 (STARDATE 2/9708)

Starfleet Command recognizes the right of each ship commander to interpret the specifications of the Prime Directive as he sees fit, consistent with the conditions of other existing general orders in effect, and based on circumstances that may arise in dealing with newly discovered sentient races.

GENERAL ORDER 31 STARDATE 2/9905)

The conditions and specifications of the Prime Directive shall henceforth apply to all sentient life forms discovered, be they of natural or artificial origin.

PAY AND PROVISIONS

This section summarizes the pay grades for Starfleet officers and enlisted men, as well as provisions for civilians in the employ of Starfleet and the families of Starfleet personnel living aboard Federation starships.

OFFICER'S PAY

Following is an updated and revised table listing monthly pay allotments for Federation Starfleet officers effective Stardate 3/0001.1. All pay grades presented here are based on credits, the universal medium of exchange used within the Federation. The retirement figures represent a base retirement distribution paid to officers, according to rank, upon completion of 15 years' service. This contribution is an additional benefit to officers retiring from Starfleet. No deductions from normal pay disbursements are required. Free transportation and medical care are also included.

STAR FLEET OFFICER PAY GRADES		
Rank	Monthly Pay	Base Retirement
Admiral (Senior)	8,000 C	25,000 C
Admiral (Branch)	7,000 C	22,000 C
Admiral (Sector)	6,500 C	20,000 C
Commodore	5,000 C	15,000 C
Fleet Captain	4,750 C	12,000 C
Captain	4,000 C	10,000 C
Commander	3,500 C	8,000 C
Lieutenant Commander	3,000 C	7,000 C
Lieutenant (Senior Grade)	2,500 C	6,000 C
Lieutenant (Junior Grade)	2,200 C	5,000 C
Ensign (Senior Grade)	1,750 C	4,000 C
Ensign (Junior Grade)	1,500 C	3,000 C
Midshipman		400 C
Cadet (Upper Class)	300 C	
Cadet (Junior Class)	200 C	

ENLISTED PERSONNEL PAY

Following are comparable monthly rates of pay (in credits) for Enlisted, Non-Commissioned Officer, and Warrant Officer grades in Starfleet. In addition to the above pay scales, all Enlisted, Petty Officer, and Warrant Officer grades receive free transportation allotments for themselves and their dependents, free medical and dental care benefits and base purchase discounts for all items purchased through Starfleet commissary stations, either aboard ship through quartermaster stores or through star base installation depositories. In addition, all enlisted personnel are granted a retirement benefit from Starfleet after the completion of their first year in service. This retirement benefit comes from a percentage of their base pay (in credits per month) that has been invested in a holding fund for use after the individual has completed 15 years of service. This contribution is in addition to standard pay rates received.

STAR FLEET ENLISTED PERSONNEL PAY GRADES		
Rank	Monthly Pay	Retirement
Master Warrant Officer	2800 C	.120 C
Warrant Officer First Class	2400 C	.100 C
Warrant Officer	2000 C	.080 C
Chief Petty Officer	2100 C	.100 C
Petty Officer 1st Class	1800 C	.090 C
Petty Officer	1500 C	.080 C
Master Specialist	1750 C	.075 C
Assistant Master Specialist	1500 C	.060 C
Specialist 1st Class	1250 C	.055 C
Specialist 2nd Class	1000 C	.045 C
Specialist	750 C	.030 C
Recruit	500 C	



PROVISIONS FOR CIVILIANS

In addition to the standard pay grades above, allowances are made for civilians, spouses, and other dependents serving and/or living with Starfleet crewmembers either aboard ship or at a star base installation. Civilian employees of Starfleet serving in specific technical, scientific, or administrative capacities receive wages equivalent to the average base pay of civilian employees in private industry: a 1,000-credit recruitment bonus and an equal amount of severance pay at the conclusion of their contract period; and free passage aboard Federation transport to any desired relocation point within the Federation. Spouses who do not have work positions aboard ship or at a ground installation receive a standard allotment of 400 credits per child or other dependent living with them. In addition, all family members receive full and complete medical coverage through ship or base medical facilities at no cost, and access privileges to base or ship quartermaster stores. Moreover, children receive the benefits of primary and secondary educational facilities as well as any remedial training that may be needed whenever facilities for such schooling exists, also without charge.

CONTROVERSIAL RULING

Infonet Bulletin, Stardate 2/7405.01 Commander Chevlek Hc'arrex, Chief Communications Officer of the *USS Excelsior* was allowed to resign his commission after the Federation Supreme Court ruled that his family bonds on Andor came first.

Commander Chevlek maintains that while serving on the *Excelsior*, he was informed that the vessel was about to undertake an unexpected two-year mission. This contradicted the earlier itinerary, which stated that the *Excelsior* was bound for Andor. The Commander's wife was with child, and he had expected to be present during the birth. To the clan-conscious Andorians, such an event is almost sacred.

The new assignment created such a conflict that the Commander tried to get himself off the ship, despite the fact he had been at the post of Communications Officer for only five months and had made a commitment to serve aboard the *Excelsior* for the next two years, which would finish off his tour.

The *Excelsior's* Captain refused Commander Chevlek's request, and so the Commander decided to take the matter to court. The court ruled that the Commander's family obligations were important enough to warrant such a leave of absence, and furthermore that the Commander had signed aboard believing the vessel would stop off at Andor for awhile.

Commander Chevlek wound up resigning his commission, which created the new issue of how to retain competent officers in Starfleet, while still allowing them to have families. The *Galaxy Class* vessels, which includes families aboard, owes its policy to this incident.

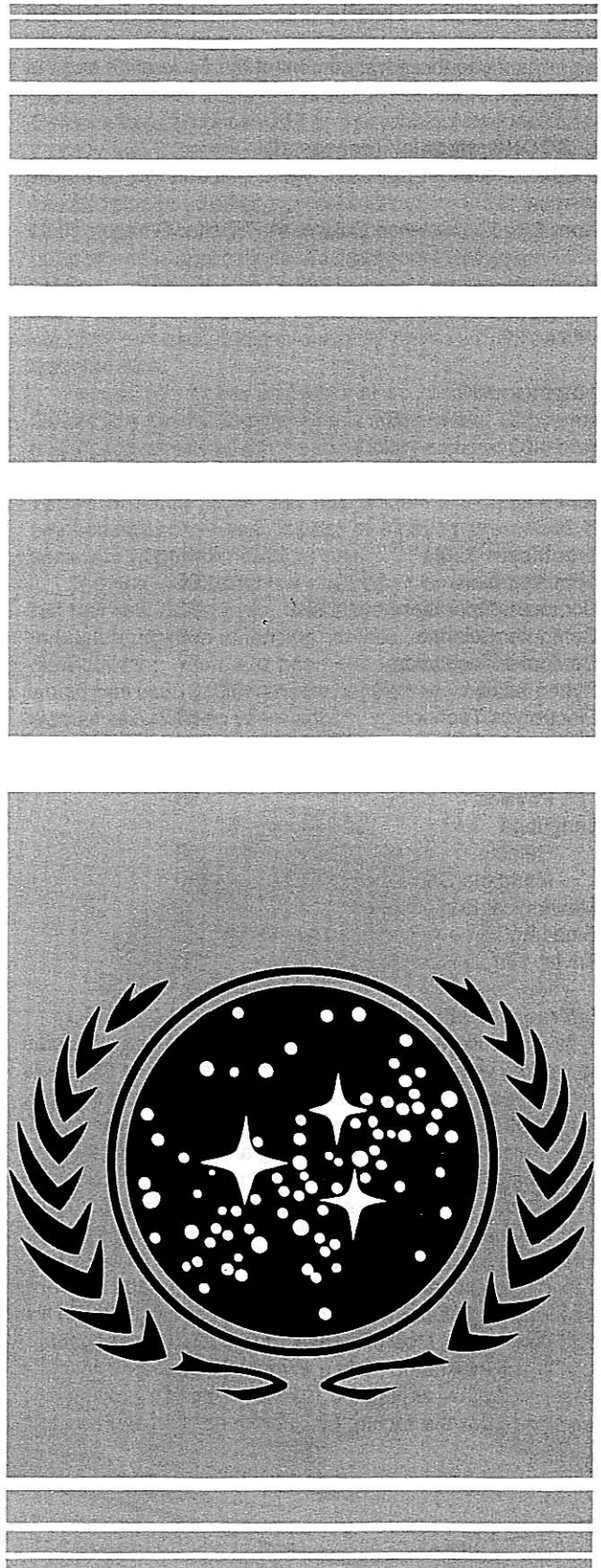

This section presents brief biographies of notable Federation citizens who, in both civilian and military capacities, have contributed significantly to the advancement of the Federation and the Grand Alliance.

Name: SOONG, Noonian (deceased)

Rank/Title: Professor Emeritus, Cygnian Institute For Advanced Cybernetics

Position: Director, Science Colony 4457-Delta, Omicron Theta

Race: Human

Age: 57 (at time of death)

Sex: Male

Attributes:

STR - 52	CHA - 57
INT - 85	LUC - 47
END - 44	PSI - 12
DEX - 46	

Significant Skills	Rating
Administration	66
Computer Operation	92
Computer Science	90
Computer Technology	77
Cybernetics	97
Electronics Technology	80
Physical Sciences	
Mathematics	78
Physics	55
Language	
Galacta	58
Mandarin Chinese	89
Mechanical Engineering	92
Small Equipment Systems Technology	88
Trivia, Terran Science Fiction	55

Brief Personal History:

A devoted follower of the late Dr. Richard Daystrom, Noonian Soong worked with Daystrom's son at Daystrom Data Concepts until receiving a research grant to study cybernetics on Cygnus. As a result of studies he conducted there, Soong became convinced that his lifelong dream of building an independent thinking machine could become reality. Lacking financial support, he could not pursue his dream until tenured as a full professor at the Cygnian Institute for Advanced Cybernetics.

For ten years, Soong relentlessly pursued his elusive dream of creating a functional positronic brain. Meanwhile, the level and magnitude of his failures virtually destroyed his reputation in the scientific community. Most of his peers regarded him as eccentric, giving him the nickname "Often Wrong Soong." The Institute eventually withdrew all funding from Dr. Soong's project, and dropped him from the faculty by "promoting" him to Professor Emeritus.



Instead of quietly accepting his forced retirement, Soong gathered together a band of devoted followers. They traveled to Omicron Theta, far from the ridicule of the scientific community. There, Soong founded a science colony under an assumed name. After resuming their experiments, the Soong group finally succeeded in creating a fully operational positronic brain. They mated the brain to an android body and christened the being "Lore."

The "Lore" construction was not a total success, however. It could not be integrated fully into Human society because, ironically, it was all too Human. The elemental wrongness of Lore so upset the other colonists that they petitioned Soong to dismantle him. It is said (though not proven) that a vengeful Lore betrayed the colony to a "Crystal Entity" that literally sucked life from the planet. Why Soong did not program Lore according to Asimov's Three Laws of Robotics remains one of the more intriguing mysteries of the galaxy.

Fortunately, Lore was disassembled before the final destruction of the colony. Soong's last act was the placement of the memories of more than 400 colonists in the mind of his second, more machine-like construct, the now famous Mr. Data.

Though Dr. Soong was definitely a workaholic, he did take time off to practice a hobby. Perhaps in reaction to the endless hours of work on the positronic brain, he became fascinated with dinosaurs, extinct Terran reptiles that weighed up to 30 tons, with literally peanut-size brains. In the hobby room adjacent to his workshop, Dr. Soong amassed a collection of books, models, paintings, and other paraphernalia on dinosaurs. His notes on cybernetics indicate that it was from contemplating the ability of the tiny saurian brain to control such a hulking body that he gained the flash of insight that made the positronic brain possible, though his notes do not elaborate further.

Noonian Soong had classically Oriental features and physical build. At the time of his work on the android project, he was a balding man whose beautiful gray eyes were hidden behind thick, heavy-rimmed spectacles.

Name: VAN GELDER, Simone
Rank/Title: Doctor of Psychology
Position: Director, Federation Special Holographic Research
 Project Dimara

Race: Human
Age: 40

Attributes:

STR — 44 CHAR — 67
 INT — 80 LUC — 25
 END — 55 PSI — 17
 DEX — 70

Significant Skills	Rating
Administration	46
Computer Operation	57
Computer Science	20
Computer Technology	37
Electronics Technology	40
Physical Science	
Mathematics	50
Laser Optics	40
Holographic	90
Physics	44
Language	
Galacta	70
Spanish	50
Portuguese	55
Mechanical Engineering	80
Small Equipment System Technology	60
Transporter Technology	88
Trivia, Terran Fashions	40

Brief Personal History:

The granddaughter of the eminent scientist, Dr. Simon Van Gelder, Simone Van Gelder is the project leader responsible for the development of the first practical Holodeck. Though Dr. Van Gelder originally conceived it as a psychological conditioning and therapy tool to permit severely disturbed patients to live out the fantasies and phobias under simulated real-life conditions, she has also pioneered other practical applications of the new Holodeck technology. These include training, amusement, theatrical, and other scientific applications. As head of the Holographics Universal Corporation, Dr. Van Gelder is under permanent contract with Star Fleet, charged with continuing research to modify and improve Holodeck designs currently employed aboard Federation starships.

In addition to her professional accomplishments, Dr. Van Gelder is a natural linguist. She is fluent in four languages, and has an acquaintance with the vocabulary and grammar of at least eight others. In addition, she is a student of clothing of various Terran historical eras, and has written a monograph on the emotional/psychological impact of clothing prescribed by the society in which an individual lives.

Simone Van Gelder is a short, wiry woman with long, flaming red hair and green eyes. She stays in good physical condition through a regimen of fencing, jiu-jitsu, and swimming. Her only distinguishing mark is a heart-shaped tattoo above her heart, which was used to differentiate her from an imposter/confidence woman about seven years ago.

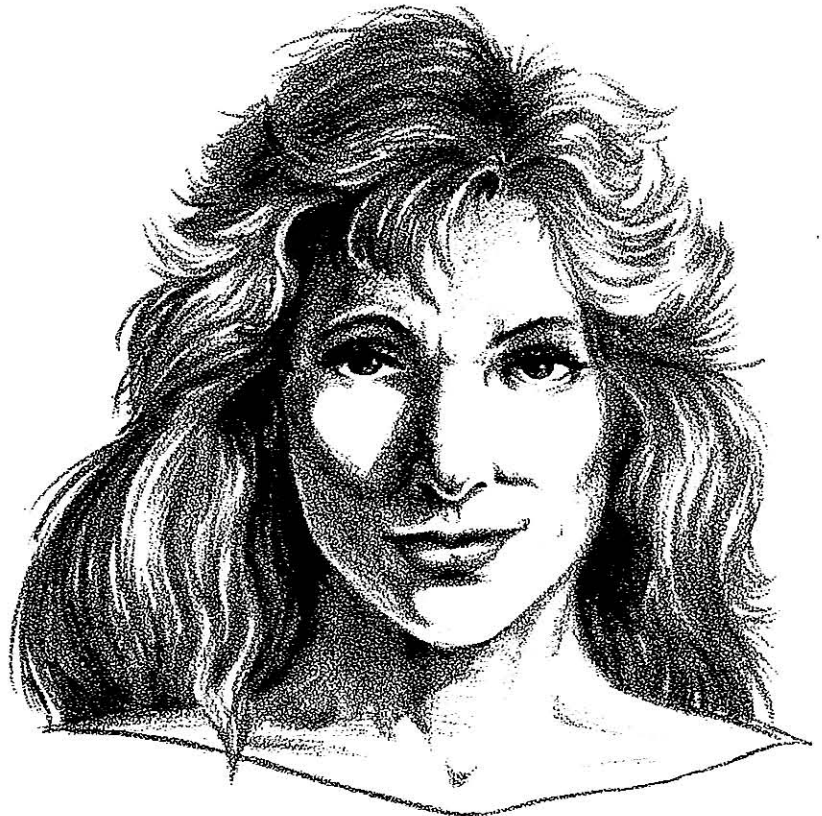

Name: ANASTAS, Koren

Rank/Title: Captain, Star Fleet Command, Military Operation Command

Position: Retired

Race: Human

Age: 55

Sex: Female

Attributes:

STR - 57 CHAR - 72
 INT - 80 LUC - 37
 END - 66 PSI - 12
 DEX - 58

Significant Skills

	Rating
Administration	30
Computer Operation	22
Computer Science	12
Federation Culture/History	40
Federation Law	20
General Medicine, Human	14
Language	
Galacta	58
Romulan	40
Klingonaase	30
Leadership	70
Personal Combat	
Armed	60
Unarmed	55
Small Unit Tactics	45
Starship Security Procedures	54
Starship Navigation	40
Starship Strategy And Tactics	55

Brief Personal History:

A genuine hero in the tradition of Garth of Izar, Captain Koren Anastas is the most decorated female Captain in Starfleet history. Among her many accomplishments, she successfully rescued a Federation convoy from the Ferengi. In a brilliant display of starship tactics against four Ferengi battlecruisers, she and her crew left three of the enemy vessels crippled with no loss of Federation life. Starfleet has also decorated Anastas for her role in the peaceful negotiations that led to the surrender of the Klingon renegade fleet of Natabor in Stardate 2/9805 and for her successful occupation of the last of the major Orion pirate outposts on Matacai in 2/9910. After serving alternately as Commandant of Starfleet Academy and Special Assistant to Starfleet Command, Operations, and Planning Division, Captain Anastas retired from the service to become cultural attache to Andor. She was one of the most successful tacticians of all time and one of the finest officers ever to graduate from Starfleet Academy.

Anastas first became interested in space exploration through studying history in her teens. She was intrigued by the fact that relations between two cultures could be formed for centuries to come after First Contact. This eventually led her to resolve to spend her adult life on the cutting edge of space exploration.

Koren Anastas is a tall woman of average build who has remained extremely trim for her age. She has shoulder-length brown hair and dark brown eyes. Her only distinguishing mark is a small, almost unnoticeable scar above her left eyebrow, the result of an explosion that occurred in prep school chem lab when she was 15. She is married to David Anastas, a career Federation diplomat, and the marriage has produced three children.



Name: PICARD, Jean-Luc
Rank/Title: Commander, *USS Enterprise*
Position: Captain

Race: Human
Age: 45
Sex: Male

Attributes:

STR — 60 CHAR — 62
 INT — 78 LUC — 40
 END — 68 PSI — 15
 DEX — 70

Significant Skills	Rating
Administration	44
Computer Operation	42
Computer Science	34
Federation Law	33
General Medicine, Human	15
Language	
Galacta	60
French	88
Klingonaase	30
Zaranite	44
Leadership	78
Negotiation and Diplomacy	45
Personal Combat	
Armed	65
Unarmed	44
Psychology, Human	40
Small Unit Tactics	56
Shuttlecraft Piloting	40
Shuttlecraft Technology	20
Starship Helm Operations	27
Starship Navigation	40
Starship Security Procedures	49
Starship Strategy and Tactics	70
Warp Drive Technology	55
Trivia	
Terran Mystery Novels	60
Terran History, France	50

Brief Personal History:

Picard is a tall, imposing man with a distinguished air. He is prematurely bald and has gray-blue eyes.

A native Terran from Paris, France, on Sol III, Captain Picard is the current commander of the *Galaxy Class USS Enterprise*. This post is the culmination of a successful career whose highlights include three successful encounters against Ferengi warships. In these actions, Captain Picard demonstrated his tactical finesse in creating several new maneuvers that have since become part of instruction at Starfleet Academy. Moreover, the Captain has been a pivotal figure in negotiations between the Federation and numerous independent races, most notably the Betazoids. He has also served in a variety of diplomatic missions to Federation member worlds. Prior to receiving his current command, Picard was the Special Liaison Officer to the Federation president.

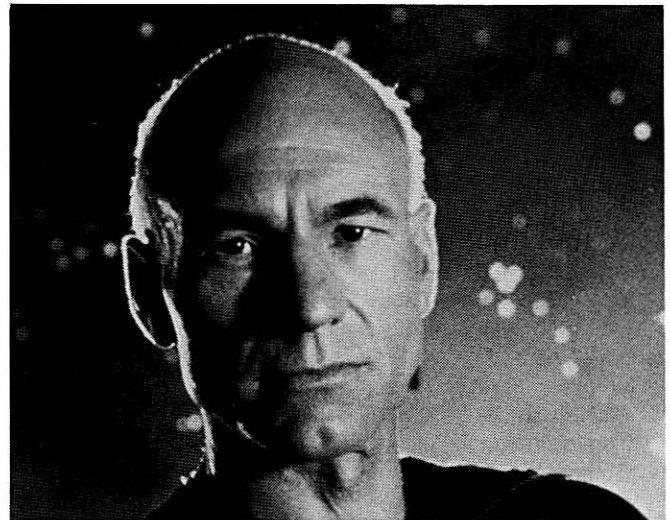

Like most truly exceptional officers, Jean-Luc Picard was not particularly brilliant compared to his fellow cadets. Indeed, he failed the Starfleet Academy entrance exam the first time around. When he was later admitted, he did well enough in classes and exercises, but his instructors did not consider him "fast track" material. Once Picard became an ensign, all that changed. His natural talents and abilities blossomed when he was first assigned space duty. By age 30, he had risen to the rank of Captain and been given command of the *USS Stargazer*.

Under Picard's guidance, the *Stargazer* began an incredible 22-year deep-space exploratory voyage, which ended with one of the first Federation encounters with a Ferengi vessel. In the finest Starfleet tradition, Captain Picard refused to engage in hostilities with the then-unknown race, even after the Ferengi ship had delivered a devastating barrage of fire that crippled the *Stargazer*. Forced to fight in order to save his crew, Picard displayed his tactical brilliance with the now-famous "Picard Maneuver," and succeeded in destroying the Ferengi ship. Though he had to abandon the *Stargazer*, Picard saved the majority of his crew and provided the Federation with valuable information on the Ferengi.

Picard was an obvious choice to command the newly commissioned *Galaxy Class* cruiser, the *USS Enterprise*. Though he is concerned about the presence of civilian dependents aboard ship (admitting that he does not "feel comfortable around children"), Captain Picard had performed brilliantly during his first year of command.

Even though Picard was offered the chance to become Commandant of Star Fleet Academy, he has shown no desire to advance to the more administrative duties associated with higher rank. Like many exceptional ship Captains before him, Jean-Luc Picard has "starship love" and will undoubtedly serve the remainder of his career aboard the *Enterprise*.

Captain Picard is exceptionally fit, even by Starfleet standards. With a wiry, muscular body and sharp intelligence reflected in his piercing eyes, he epitomizes the old saying about "a sound mind in a sound body." Picard is totally bald, a feature that seems to accentuate his personal magnetism. His ability to listen intently when anyone speaks to him also contributes to his charisma.

Name: WORF

Rank/Title: Lieutenant, Star Fleet Command

Position: Security Chief, *USS Enterprise*

Race: Imperial Klingon

Age: 38

Sex: Male

Attributes:

STR — 80	CHAR — 37
INT — 72	LUC — 30
END — 70	PSI — 09
DEX — 69	

Significant Skills

	Rating
Administration	28
Computer Operation	33
Computer Science	22
Federation Culture/History	30
Federation Law	20
General Medicine, Human	10
Klingon History/Culture	55
Language	
Galacta	80
Klingonaase	25
Leadership	50
Personal Combat	
Armed	77
Unarmed	80
Psychology	
Human	22
Klingon	67
Small Unit Tactics	40
Shuttlecraft Piloting	12
Starship Helm Operations	20
Starship Navigation	33
Starship Security Procedures	55
Warp Drive Technology	20

Brief Personal History:

The only survivor of a Romulan attack on his colony homeworld of Khitomer, Worf was rescued by a Starfleet officer and raised as a Human child on the farming world of Gault. The only Klingon officer in Starfleet, Worf excelled during his years at Starfleet Academy, graduating second in his class. Since that time, he has served in a variety of command positions, including both shipboard and star base ground assignments. His background has permitted Worf to serve in several diplomatic missions to the Free Worlds of Klinzai, but Worf has repeatedly demonstrated his reluctance to leave Starfleet—which he now considers his home—in favor of service with his Klingon compatriots aboard a Klingon vessel. Following the death of Lieutenant Tasha Yar, Worf succeeded to command position as the Chief Security Officer aboard the *USS Enterprise*.

Though Worf had no contact with other Klingons after he was adopted by Humans, he remains a true Klingon. He prefers to speak Galacta because he lacks fluency in Klingonaase, yet in other respects, he behaves exactly like a Klingon. For example, he considers himself a Klingon warrior and other Klingons automatically accept him as such, despite the fact of his successful adaptation to Human behavioral norms and his full integration into Federation society. His instinctive ability to participate in the Klingon death rite and his automatic combative responses to threats and potential hostilities all point to genetics rather than culture as a major factor in Klingon behavior.

Physically, Worf is typical of Imperial Klingons in height, weight, and strength. His physiognomy is also classically Klingon. He has brown eyes and brown hair.



OFFICER'S MANUAL

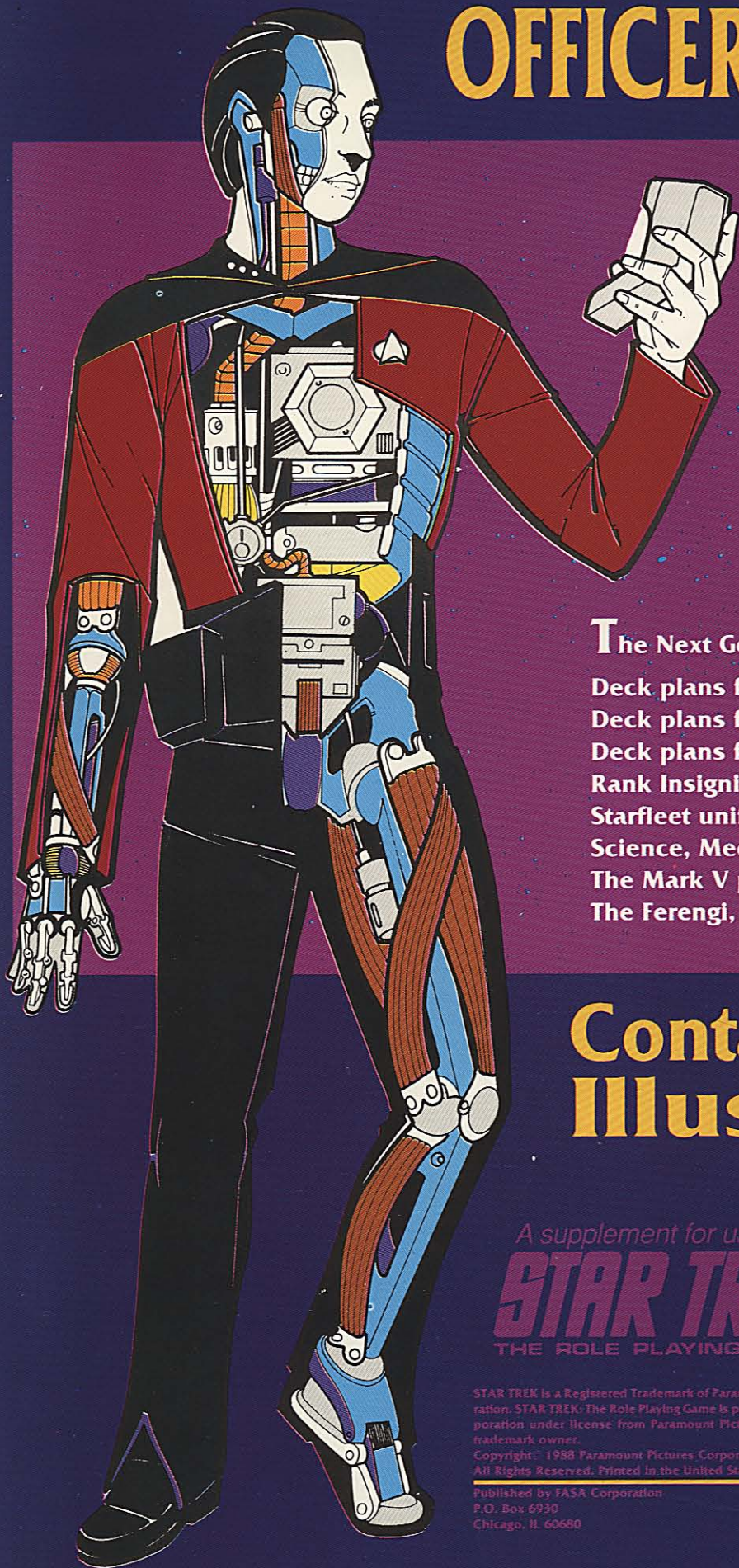

"**STAR TREK: The Next Generation**" Officers Manual is an introduction to Starfleet of the Next Generation. Includes: Changes to ship's operational procedures that reflect the new officer positions, detailed information about new equipment, and extensive sections about the GALAXY CLASS cruiser and artificial persons like LCDR Data.

A must for STAR TREK fans of every age.

The Next Generation Officer's Manual contains:

- Deck plans for the main bridge
- Deck plans for the battle bridge
- Deck plans for Officers and Crews Quarters
- Rank Insignias
- Starfleet uniforms
- Science, Medical, and Engineering Tricorders
- The Mark V personal phaser and other weapons
- The Ferengi, the Q and other new alien races

Contains over 80 Illustrations!

A supplement for use with
STAR TREK[®]
THE ROLE PLAYING GAME

FASA
CORPORATION



STAR TREK is a Registered Trademark of Paramount Pictures Corporation. STAR TREK: The Role Playing Game is published by FASA Corporation under license from Paramount Pictures Corporation, the trademark owner.
Copyright © 1988 Paramount Pictures Corporation.
All Rights Reserved. Printed in the United States of America.

Published by FASA Corporation
P.O. Box 6930
Chicago, IL 60680



ISBN: 1-55560-079-4 FASA 1500